

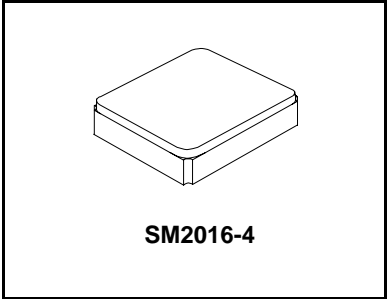

**SF1186H-3**

**1575.42 MHz  
SAW Filter**



- RF Filter Designed for Front End GPS Applications
- Low Insertion Loss
- Improved Rejection
- 2.0 x 1.6 mm Surface-mount Case
- Complies with Directive 2002/95/EC (RoHS)



**Absolute Maximum Ratings**

Rating	Value	Units
Maximum Incident Power in Passband	+10	dBm
Maximum DC Voltage on any Non-grounded Terminal	3	VDC
Filter Operating Temperature Range	-40 to +105	°C
Filter Storage Temperature Range	-55 to +105	°C
Storage Temperature Range in Tape & Reel	-40 to +85	°C
Maximum Soldering Profile	265°C for 10 s	

**Electrical Characteristics**

Characteristic	Sym	Notes	Min	Typ	Max	Units
Center Frequency	$f_C$		1575.42			MHz
Maximum Insertion Loss, 1574.42 to 1576.42 MHz	$IL_{MAX}$			1.15	1.8	dB
Amplitude Ripple, 1574.42 to 1576.42 MHz				0.1	0.5	dB <sub>P-P</sub>
VSWR, 1574.42 to 1576.42 MHz				1.2	1.9	
Attenuation:						dB
100 to 960 MHz			31	33		
960 to 1460 MHz			31	33		
1460 to 1513 MHz			22	26		
1648 to 1710 MHz			22	28		
1710 to 1990 MHz			25	32		
1990 to 2300 MHz			25	30		
2300 to 4000 MHz			29	31		
4000 to 6000 MHz			20	24		
Source impedance	$Z_S$			50		$\Omega$
Load impedance	$Z_L$			50		$\Omega$

Single-ended Input / Output Impedance Match	No matching network required for operation at 50 ohms
Case Style	SM2016-4
Lid Symbolization, Device, Date Code	3A



**CAUTION: Electrostatic Sensitive Device. Observe precautions for handling.**

**Notes:**

1. US and international patents may apply.
2. RFM, stylized RFM logo, and RF Monolithics, Inc. are registered trademarks of RF Monolithics, Inc.

## Frequency Characteristics

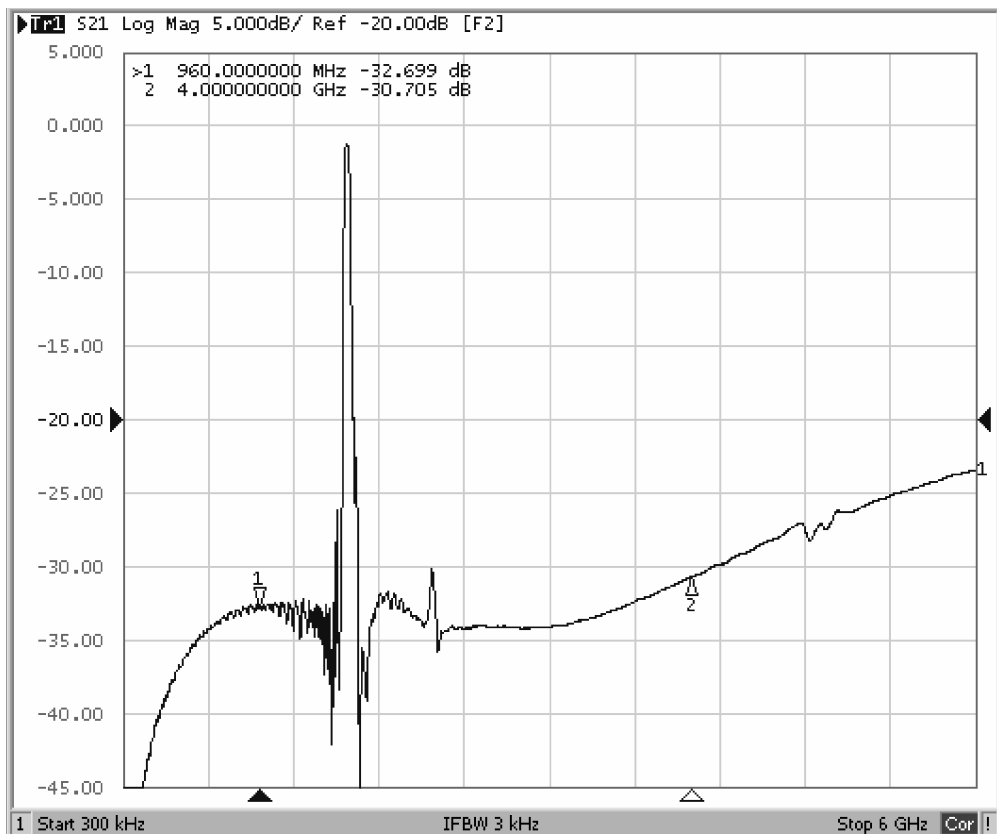
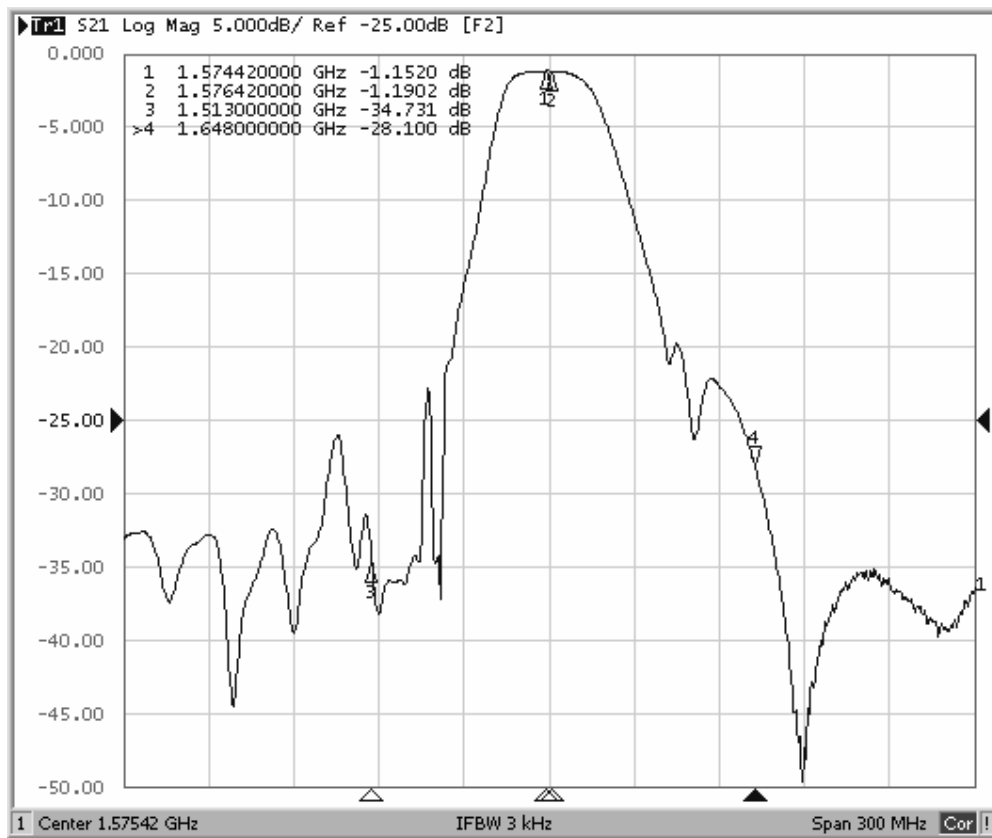

## Reflection Functions

S11

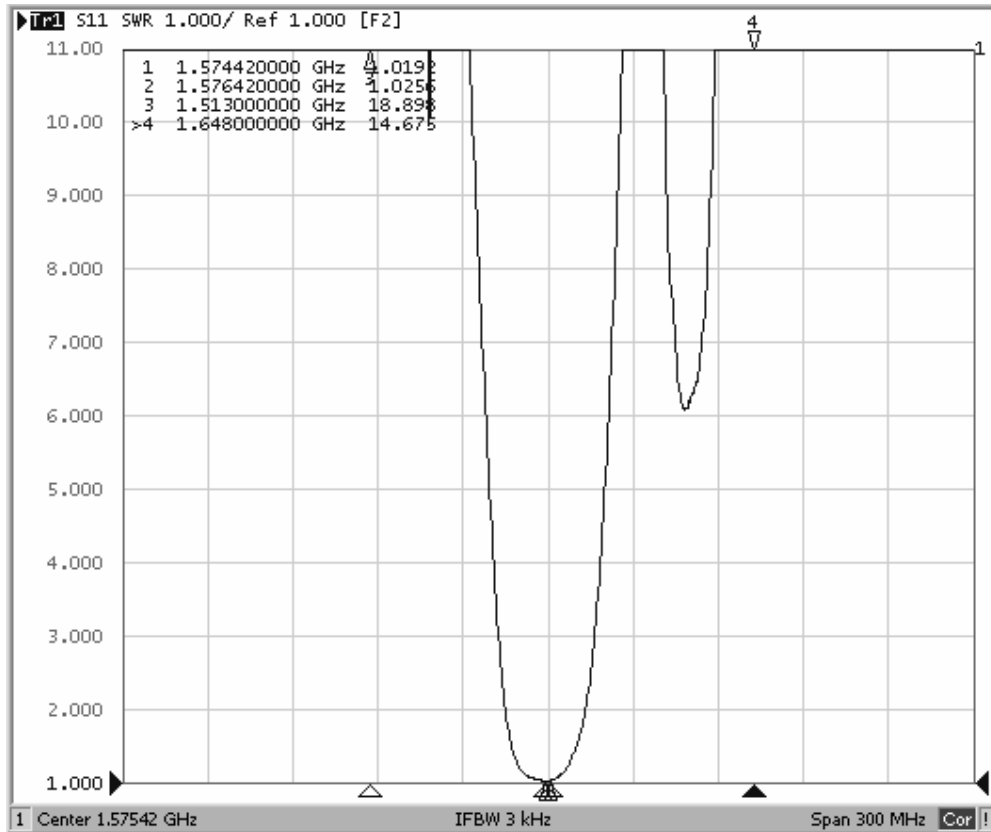

S22

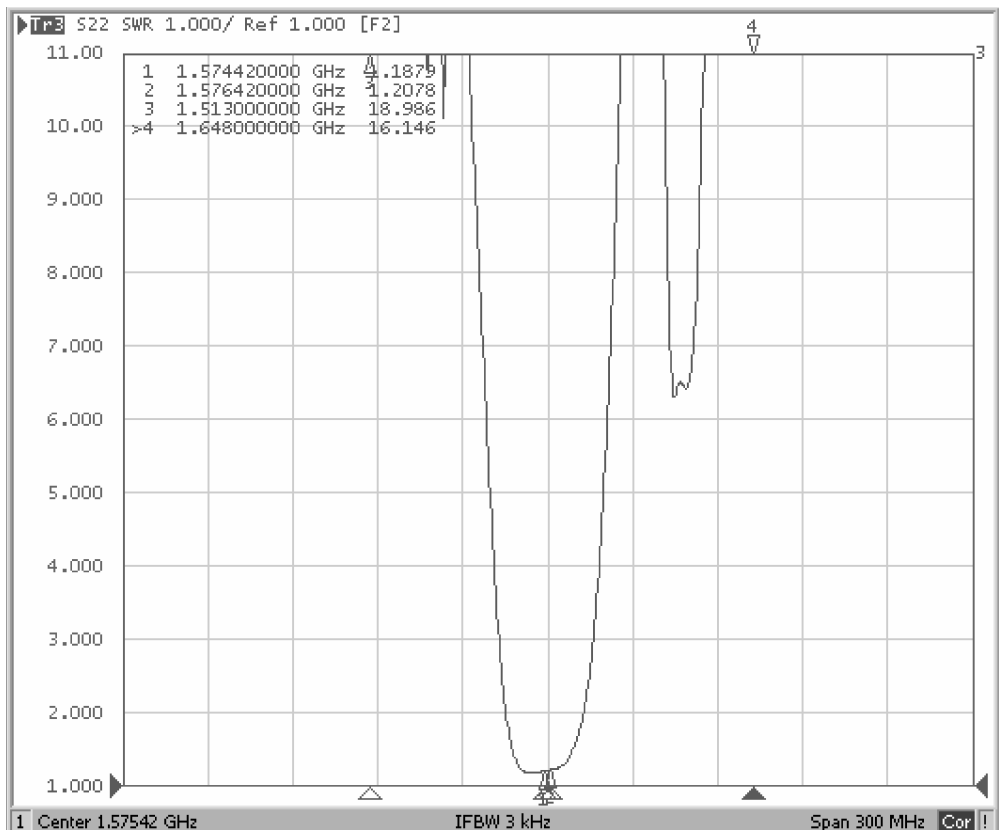

# SM2016-4 Case

## 4-Terminal Ceramic Surface-Mount Case 2.0 X 1.6 mm Nominal Footprint

### Electrical Connections

Connection	Terminals
Input	1
Output	3
Ground	2, 4

Dimensions	Millimeters			Inches		
	Min	Nom	Max	Min	Nom	Max
A		1.60				
B		2.00				
C		0.90				
D		0.10				
E		0.10				
F		0.70				
G		0.50				
H		0.10				

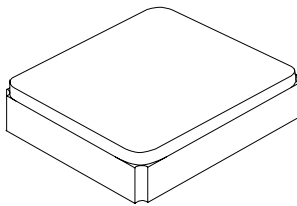

PCB PAD LAYOUT

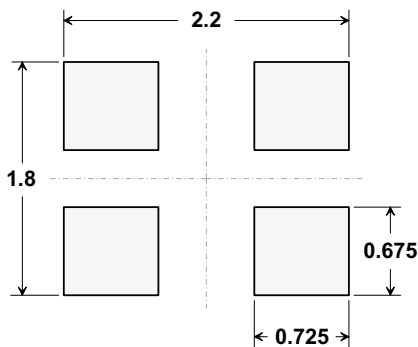

Dimensions in mm  
All pads have the same dimensions

TOP VIEW

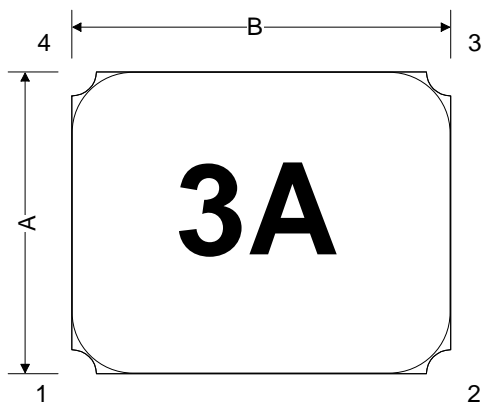

SIDE VIEW

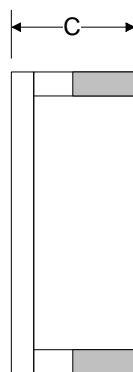

BOTTOM VIEW

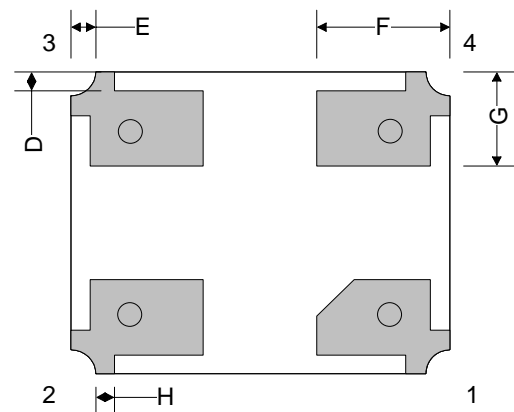

**F. PACKING:**

**1. REEL DIMENSION**

( Reel Count : 7"=2000 typ. ; 13"=10000 typ.)

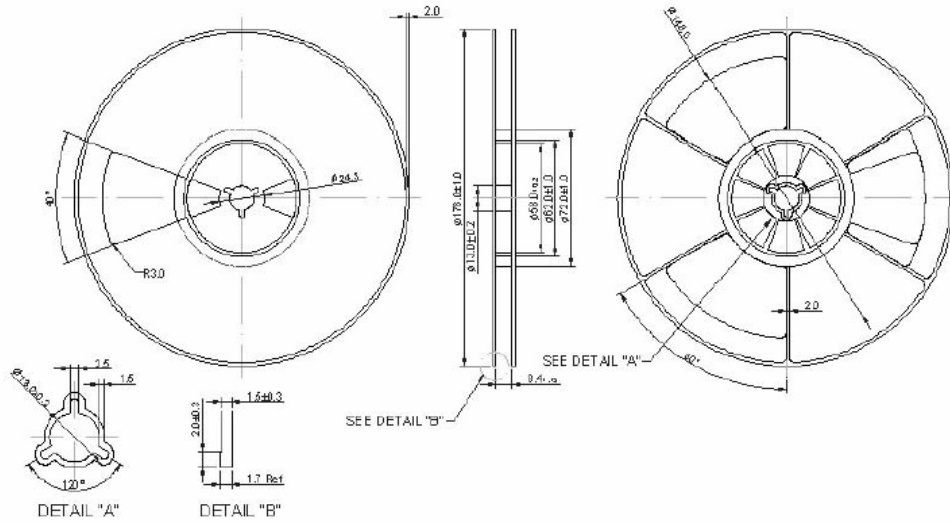

**2. TAPE DIMENSION**

