

V <sub>RSM</sub> V <sub>RRM</sub>  V	I <sub>D</sub> (T <sub>case</sub> = ...)			
	17 A = (75 °C)		20 A (73 °C)	
	Types	R <sub>min</sub> Ω	Types	R <sub>min</sub> Ω
100	<b>SKB 25/01</b>	0,1	–	–
200	<b>SKB 25/02</b>	0,15	<b>SKD 25/02</b>	0,15
400	<b>SKB 25/04</b>	0,3	<b>SKD 25/04</b>	0,3
600	<b>SKB 25/06</b>	0,5	–	–
800	<b>SKB 25/08</b>	0,7	<b>SKD 25/08</b>	0,7
1200	<b>SKB 25/12</b>	1	<b>SKD 25/12</b>	1
1400	<b>SKB 25/14</b>	1,2	<b>SKD 25/14</b>	1,2
1600	<b>SKB 25/16</b>	1,5	<b>SKD 25/16</b>	1,5

## Power Bridge Rectifiers

### SKB 25 SKD 25

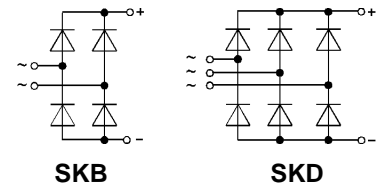
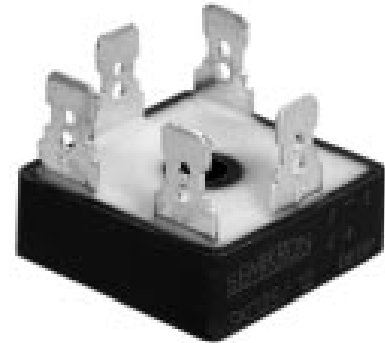

Symbol	Conditions	SKB 25	SKD 25	Units
I <sub>D</sub>	T <sub>amb</sub> = 45 °C; isolated <sup>1)</sup> chassis <sup>2)</sup> R4A/120 P1A/120	3,5	3,5	A
		10	12	A
		14	15	A
		17	20	A
I <sub>DCL</sub>	T <sub>amb</sub> = 45 °C; isolated <sup>1)</sup> chassis <sup>2)</sup> R4A/120 P1A/120	3	3,5	A
		9,5	12	A
		12	15	A
		14	20	A
I <sub>FSM</sub>	T <sub>vj</sub> = 25 °C, 10 ms	370		A
i <sup>2</sup> t	T <sub>vj</sub> = 150 °C, 10 ms	320		A
	T <sub>vj</sub> = 25 °C, 8,3...10 ms	680		A <sup>2</sup> s
V <sub>F</sub>	T <sub>vj</sub> = 25 °C; I <sub>F</sub> = 150 A	2,2		V
		0,85		V
V <sub>(TO)</sub>	T <sub>vj</sub> = 150 °C			V
r <sub>T</sub>	T <sub>vj</sub> = 150 °C	12		mΩ
I <sub>RD</sub>	T <sub>vj</sub> = 25 °C; V <sub>RD</sub> = V <sub>RRM</sub>	0,3		mA
		5		mA
t <sub>rr</sub>	T <sub>vj</sub> = 25 °C	typ. 10		μs
f <sub>G</sub>		2000		Hz
R <sub>thjc</sub>	total	2	1,75	°C/W
R <sub>thch</sub>	total	0,15		°C/W
R <sub>thja</sub>	isolated <sup>1)</sup>	15		°C/W
	chassis <sup>2)</sup>	4,7		°C/W
	R4A/120	3,6		°C/W
	P1A/120	2,75		°C/W
T <sub>vj</sub>		– 40...+ 150		°C
T <sub>stg</sub>		– 55...+ 150		°C
V <sub>isol</sub>	a.c. 50...60 Hz; r.m.s.; 1 s/ 1 min	3000 / 2500		V~
RC	P <sub>R</sub> = 1 W	50		Ω
		0,1		μF
		20		A
F <sub>u</sub>		2 ± 15 %		Nm
M <sub>1</sub>	to heatsink	SI units		Nm
		US units	18 ± 15 %	lb. in.
w		24	26	g
Case		G 10	G 11	

### Features

- Square plastic case with isolated metal base plate and fast-on connectors
- Blocking voltage to 1600 V
- High surge currents
- **SKB** = single phase bridge rectifier
- **SKD** = three phase bridge rectifier
- Easy chassis mounting
- UL recognized, file no. E 63 532

### Typical Applications

- Single and three phase rectifiers for power supplies
- Input rectifiers for variable frequency drives
- Rectifiers for DC motor field supplies
- Battery charger rectifiers

<sup>1)</sup> Freely suspended or mounted on an insulator

<sup>2)</sup> Mounted on a painted metal sheet of min. 250 x 250 x 1 mm

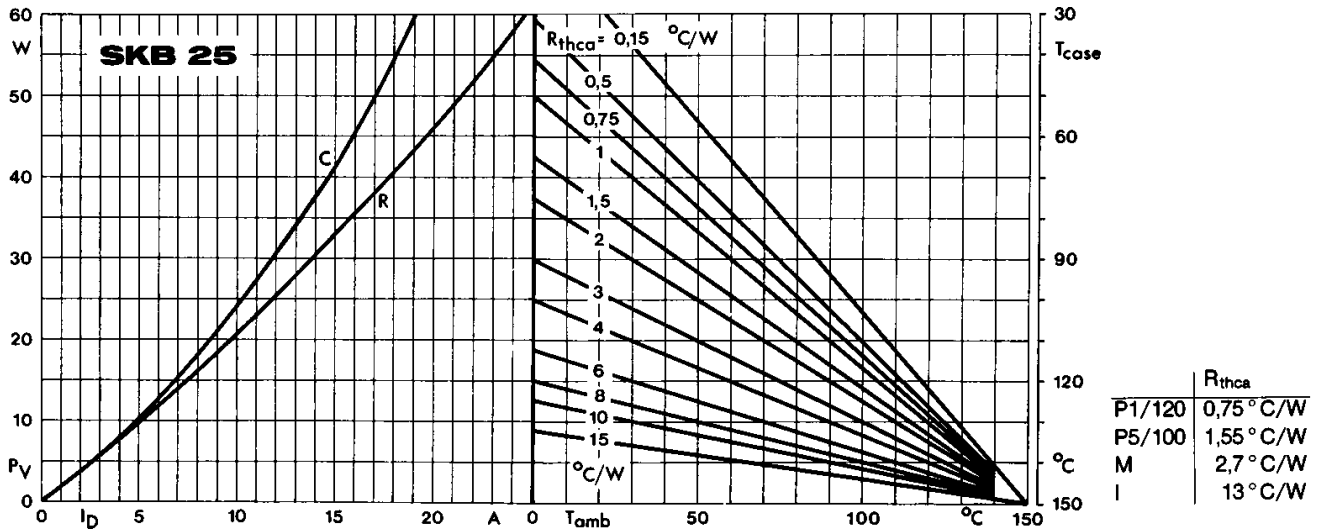

Fig. 3 a Power dissipation vs. output current and case temperature

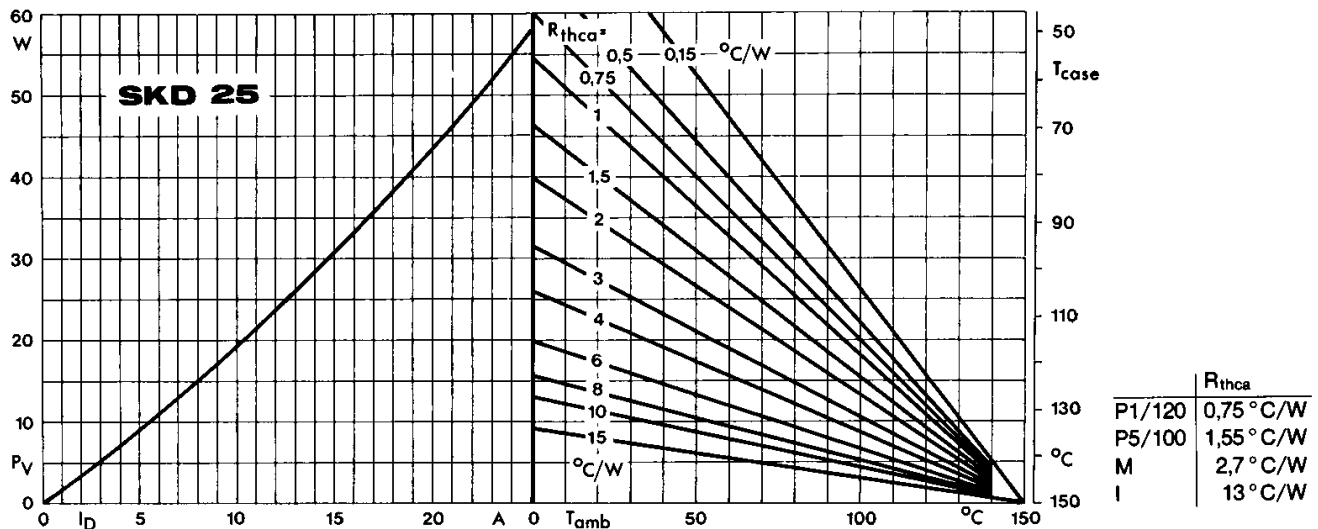

Fig. 3 b Power dissipation vs. output current and case temperature

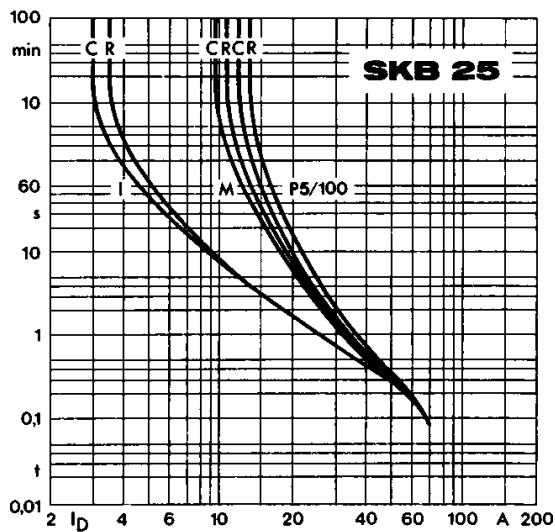

Fig. 6 a Rated overload current vs. time

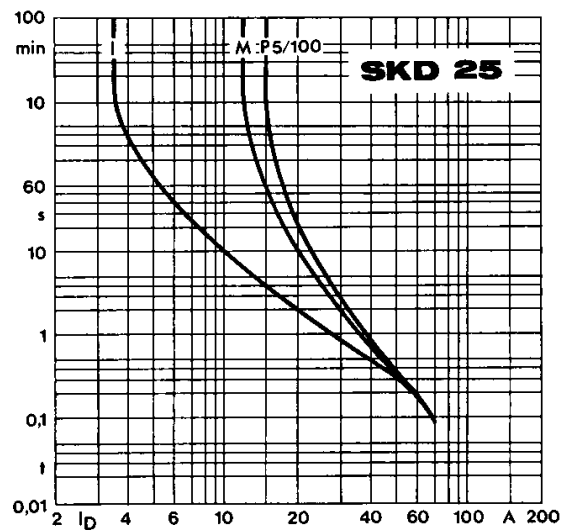

Fig. 6 b Rated overload current vs. time

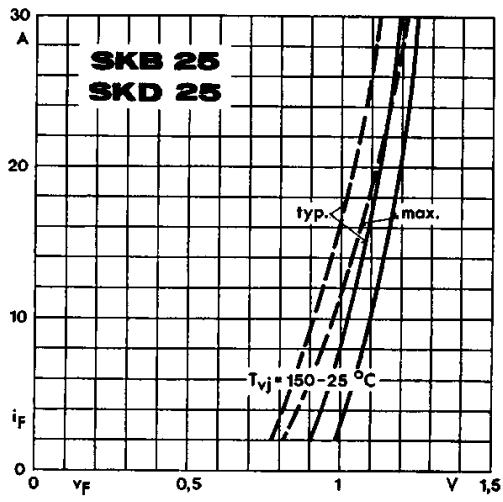
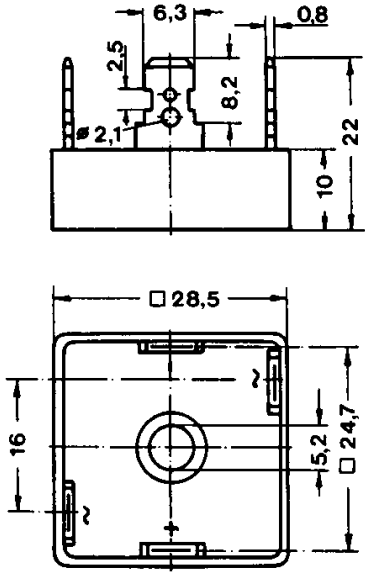

Fig. 9 Forward characteristics of a single diode

**SKB 25**  
Case G 10



**SKD 25**  
Case G 11

