



## SM25 / SM30 / SM42 Series Miniature SMD Crystal

March 2008

- The Pletronics' SM42 Series is a miniature surface mount crystal
- The package is ideal for automated surface mount assembly and reflow practices.
- Tape and Reel packaging
- 3 MHz to 70 MHz
- AT Cut Crystal
- SM42: 4.7 x 12.9 x 4.6 mm
- SM30: 4.7 x 12.9 x 3.5 mm
- SM25: 4.7 x 12.9 x 2.9 mm

**Pletronics Inc. certifies this device is in accordance with the RoHS 5/6 (2002/95/EC) and WEEE (2002/96/EC) directives.**

Pletronics Inc. guarantees the device does not contain the following:  
Cadmium, Hexavalent Chromium, Lead (<1000 ppm), Mercury, PBB's, PBDE's  
Weight of the Device: 0.62 grams  
Moisture Sensitivity Level: 1 As defined in J-STD-020C  
Second Level Interconnect code: e1, e2 or e3

### Electrical Specification:

Item	Min	Max	Unit	Condition		
Frequency Range	3	70	MHZ	AT cut		
Calibration Frequency Tolerance	-	-	ppm	at +25°C ± 3°C	see table on page 3 for available options	
Frequency Stability over OTR	-	-	ppm			
Equivalent Series Resistance (ESR)	-	150	Ohms	3 to 4 MHZ	SM42	Fundamental
	-	130	Ohms	4 to 5 MHZ	SM30/SM42	
	-	100	Ohms	5 to 6 MHZ	SM30/SM42	
	-	90	Ohms	6 to 7 MHZ	SM30/SM42	
	-	80	Ohms	7 to 9 MHZ	SM30/SM42	
	-	70	Ohms	9 to 10 MHZ	SM25/SM30/SM42	
		60	Ohms	10 to 13 MHZ	SM25/SM30/SM42	
		50	Ohms	13 to 15 MHZ	SM25/SM30/SM42	
		40	Ohms	15 to 27 MHZ	SM25/SM30/SM42	
	-	30	Ohms	27 to 36 MHZ	SM25/SM30/SM42	
	-	100	Ohms	27 to 32 MHZ	SM25/SM30/SM42	3 <sup>rd</sup> Overtone
	-	80	Ohms	32 to 50 MHZ	SM25/SM30/SM42	
	-	60	Ohms	50 to 70 MHZ	SM25/SM30/SM42	
Drive Level	-	1	mW	use 100 µW for testing		
Shunt Capacitance (C0)	-	7	pF	Pad to Pad capacitance		
Aging	-5	+5	ppm /Yr	at +25°C ± 3°C		
Specified Temperature Range	-40	+85	°C	see table on page 3 for available options		
Storage Temperature Range	-55	+125	°C			

**AT Cut Crystal Frequency  
versus Temperature  
Typical Performance:**

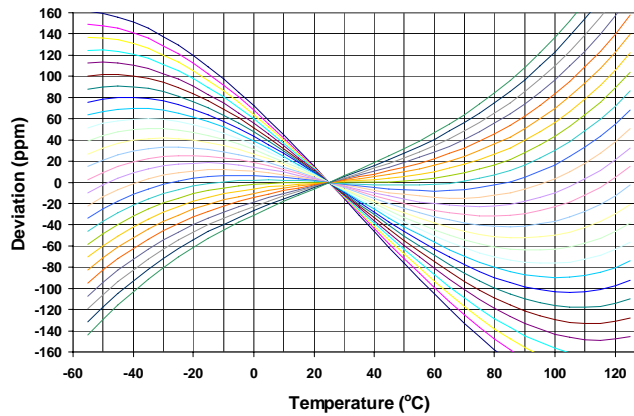

**Part Marking:**

**SxFFFFPymdz or LSxFFFFzywwz**

**Legend:**

- S = Model code for SM42, Z = SM25, 5 = SM30
- x = Capacitance load code from below
- FFFFF = Frequency coded
- P or L = Pletronics
- ymd or yww = Date of Manufacture (year, month and day) or year, week week
- All other marking is internal factory codes

Some frequency marking examples: 3.579545M = 03579, 14.31818M = 14181, 24.0M = 24000

Specifications such as frequency tolerance and operating temperature range, etc. are not identified from the marking. External packaging labels and packing list will correctly identify the ordered Pletronics part number.

Code	A	B	C	D	E	F	G	H	J	K	L	M	N	P	Q	R	S	T	U	V	W	X	Y
pF	10	12	13	8	15	18	20	22	24	26	28	30	32	34	36	27	series	33	50	19	16	17	14

**Codes for Date Code YMD**

Code	6	7	8	9	0	1	2
Year	2006	2007	2008	2009	2010	2011	2012

Code	A	B	C	D	E	F	G	H	J	K	L	M
Month	JAN	FEB	MAR	APR	MAY	JUN	JUL	AUG	SEP	OCT	NOV	DEC

Code	1	2	3	4	5	6	7	8	9	A	B	C
Day	1	2	3	4	5	6	7	8	9	10	11	12
Code	D	E	F	G	H	J	K	L	M	N	P	R
Day	13	14	15	16	17	18	19	20	21	22	23	24
Code	T	U	V	W	X	Y	Z					
Day	25	26	27	28	29	30	31					

**Part Number:**

SM42 -18 -14.31818M -50 H 1 G G -XX

See chart below for available options

Internal code or blank
<b>Highest Specified Operating Temperature</b> <b>A</b> = 40°C <b>G</b> = 70°C <b>B</b> = 45°C <b>H</b> = 75°C <b>C</b> = 50°C <b>J</b> = 80°C <b>D</b> = 55°C <b>K</b> = 85°C <b>E</b> = 60°C <b>F</b> = 65°C
<b>Lowest Specified Operating Temperature</b> <b>A</b> = +10°C <b>F</b> = -15°C <b>L</b> = -40°C <b>B</b> = +5°C <b>G</b> = -20°C <b>C</b> = 0°C <b>H</b> = -25°C <b>D</b> = -5°C <b>J</b> = -30°C <b>E</b> = -10°C <b>K</b> = -35°C
<b>Mode:</b> 1 = Fundamental    3 = 3rd Overtone
<b>Frequency Stability</b> See chart below
<b>Calibration Frequency Tolerance</b> <b>15</b> = ± 15 ppm at 25°C ± 3°C <b>20</b> = ± 20 ppm at 25°C ± 3°C <b>30</b> = ± 30 ppm at 25°C ± 3°C (Standard)
<b>Frequency in MHZ</b>
<b>Clload in pF</b> Parallel Resonance from 09 to 44 pF or <b>SR</b> = Series Resonance
<b>Series Model</b>

Operating Temperature Range	CODE	Available Frequency Stability versus Temperature in ppm					
		D	E	F	G	H	J
		± 10	± 15	± 20	± 30	± 50	± 100
0 to +45°C	CB	•	•	•	•	•	•
0 to +50°C	CC	•	•	•	•	•	•
0 to +60°C	CE	•	•	•	•	•	•
0 to +70°C	CG	•	•	•	•	STD	•
-10 to +50°C	EC	•	•	•	•	•	•
-10 to +60°C	EE	•	•	•	•	•	•
-10 to +75°C	EH	•	•	•	•	•	•
-20 to +70°C	GG	•	•	•	•	•	•
-20 to +75°C	GH	•	•	•	•	•	•
-30 to +75°C	JH	•	•	•	•	•	•
-30 to +80°C	JJ	•	•	•	•	•	•
-30 to +85°C	JK	•	•	•	•	•	•
-35 to +80°C	KJ		•	•	•	•	•
-40 to +85°C	LK		•	•	•	•	•

### Legacy Part Number (not for new designs):

SM42	B	E	-18	-11.0592M	-XX	
						<b>Internal code or blank</b>
						<b>Frequency in MHZ</b>
						<b>Load in pF</b> Parallel Resonance in pF or <b>SR</b> = Series Resonance
						<b>Operating Temperature Range</b> Blank = 0 to + 70°C (STD) <b>E</b> = -40 to +85°C
						<b>Calibration Tolerance / Frequency Stability</b> Blank = 30/50 (STD) <b>B</b> = 30/30 <b>C</b> = 15/30 <b>D</b> = 10/20 (not all frequencies)
						<b>Series Model</b>





### Reliability: Environmental Compliance

Parameter	Condition
Mechanical Shock	MIL-STD-883 Method 2002, Condition B
Vibration	MIL-STD-883 Method 2007, Condition A
Solderability	MIL-STD-883 Method 2003
Thermal Shock	MIL-STD-883 Method 1011, Condition A

### Package Labeling

Label is 1" x 2.6" (25.4mm x 66.7mm)  
Font is Courier New  
Bar code is 39-Full ASCII

Label is 1" x 2.6" (25.4mm x 66.7mm)  
Font is Arial

<b>P/N:</b>  SM42-18-25.0M	
<b>Customer P/N:</b>  12345678	
<b>Qty:</b>  1000 <b>D/C</b>  0632-WYLF	

<p>RoHS Compliant</p> <p>2nd LvL Interconnect</p> <p>Category=e1</p> <p>Max Safe Temp=260C for 10s 2X Max</p>
---

<p>RoHS Compliant</p> <p>2nd LvL Interconnect</p> <p>Category=e3</p> <p>Max Safe Temp=260C for 10s 2X Max</p>
---

<p>RoHS Compliant</p> <p>2nd LvL Interconnect</p> <p>Category=e2</p> <p>Max Safe Temp=260C for 10s 2X Max</p>
---

## Mechanical:

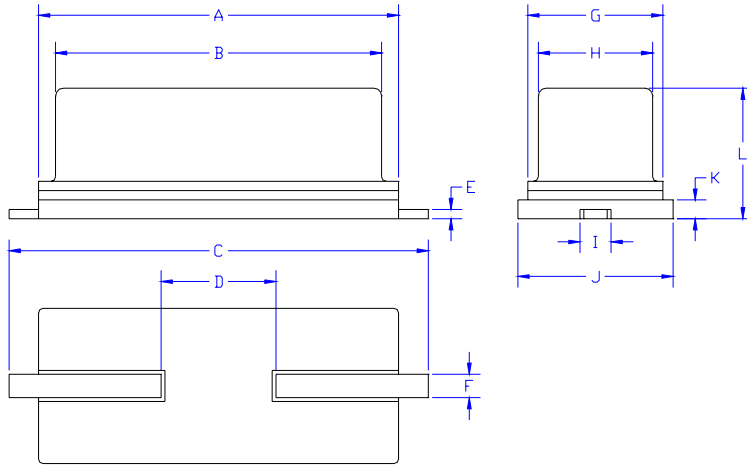

Contacts (3 types of lead plating used):

Matte Tin (Sn)

Tin over Copper (SnCu)

SAC (SnAgCu)

**Not to Scale**

	Inches	mm
A	0.457 max	11.60 max
B	0.414 max	10.50 max
C	0.532 max	13.50 max
D	0.192 ± 0.008	4.88 ± 0.20
E	0.012 ± 0.004	0.30 ± 0.10
F	0.030 ± 0.008	0.75 ± 0.20
G	0.197 max	5.00 max
H	0.145 max	3.68 max
I	0.040 max	1.00 max
J	0.197 max	5.00 max
K <sup>1</sup>	0.016	0.40
L SM42	0.182 max	4.60 max
L SM30	0.138 max	3.50 max
L SM25	0.114 max	2.90 max

<sup>1</sup> Typical dimensions

## Layout and application information

- Trace lengths to the crystal should be kept as short as possible.
- The crystal connections are sensitive to noise.
- Load may need to be determined experimentally on the actual PCB.

### Reflow Cycle (typical for lead free processing)

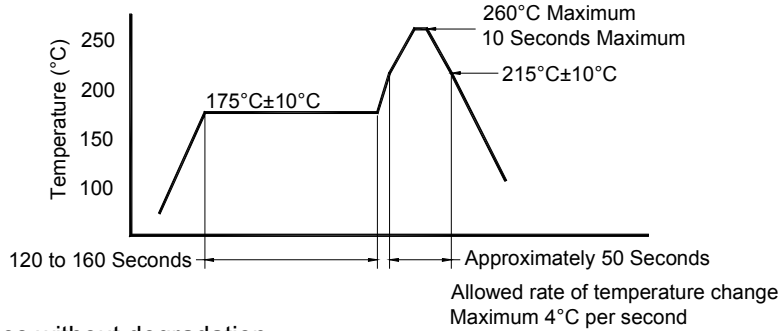

The part may be reflowed 2 times without degradation.

### Tape and Reel: available for quantities of 1000 per reel, cut tape for < 250

Constant Dimensions Table 1								
Tape Size	D0	D1 Min	E1	P0	P2	S1 Min	T Max	T1 Max
8mm	1.5	1.0	1.75	4.0	2.0 ± 0.05	0.6	0.25	0.1
12mm		1.5			2.0 ± 0.1			
16mm	+0.1 -0.0	1.5	± 0.1	± 0.1	2.0 ± 0.1			
24mm		1.5						

Variable Dimensions Table 2							
Tape Size	B1 Max	E2 Min	F	P1	T2 Max	W Max	Ao, Bo & Ko
24 mm	18	14.25	7.5 ± 0.1	12.0 ± 0.1	8	16.3	Note 1

Note 1: Embossed cavity to conform to EIA-481-B      Dimensions in mm      Not to scale

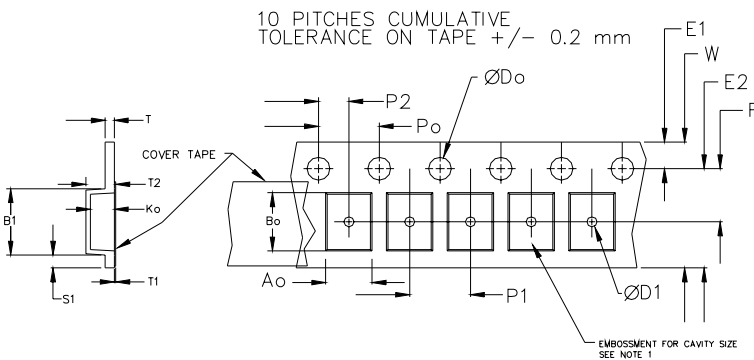
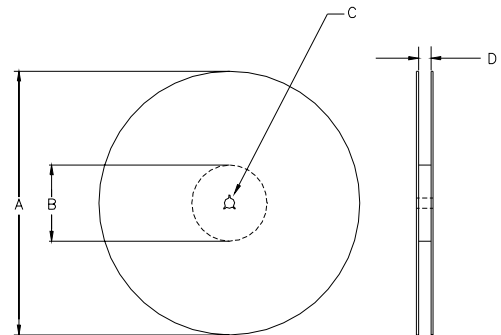

USER DIRECTION OF UNREELING →

REEL DIMENSIONS					
A	inches	7.0	10.0	13.0	Tape Width
	mm	177.8	254.0	330.2	
B	inches	2.50	4.00	3.75	Tape Width
	mm	63.5	101.6	95.3	
C	mm	13.0 +0.5 / -0.2			Tape Width
D	mm	24.4 +2.0 -0.0	24.4 +2.0 -0.0	24.4 +2.0 -0.0	

Reel dimensions may vary from the above

### IMPORTANT NOTICE

Pletronics Incorporated (PLE) reserves the right to make corrections, improvements, modifications and other changes to this product at anytime. PLE reserves the right to discontinue any product or service without notice. Customers are responsible for obtaining the latest relevant information before placing orders and should verify that such information is current and complete. All products are sold subject to PLE's terms and conditions of sale supplied at the time of order acknowledgment.

PLE warrants performance of this product to the specifications applicable at the time of sale in accordance with PLE's limited warranty. Testing and other quality control techniques are used to the extent PLE deems necessary to support this warranty. Except where mandated by specific contractual documents, testing of all parameters of each product is not necessarily performed.

PLE assumes no liability for application assistance or customer product design. Customers are responsible for their products and applications using PLE components. To minimize the risks associated with the customer products and applications, customers should provide adequate design and operating safeguards.

PLE products are not designed, intended, authorized or warranted to be suitable for use in life support applications, devices or systems or other critical applications that may involve potential risks of death, personal injury or severe property or environmental damage. Inclusion of PLE products in such applications is understood to be fully at the risk of the customer. Use of PLE products in such applications requires the written approval of an appropriate PLE officer. Questions concerning potential risk applications should be directed to PLE.

PLE does not warrant or represent that any license, either express or implied, is granted under any PLE patent right, copyright, artwork or other intellectual property right relating to any combination, machine or process which PLE product or services are used. Information published by PLE regarding third-party products or services does not constitute a license from PLE to use such products or services or a warranty or endorsement thereof. Use of such information may require a license from a third party under the patents or other intellectual property of the third party, or a license from PLE under the patents or other intellectual property of PLE.

Reproduction of information in PLE data sheets or web site is permissible only if the reproduction is without alteration and is accompanied by associated warranties, conditions, limitations and notices. Reproduction of this information with alteration is an unfair and deceptive business practice. PLE is not responsible or liable for such altered documents.

Resale of PLE products or services with statements different from or beyond the parameters stated by PLE for that product or service voids all express and implied warranties for the associated PLE product or service and is an unfair or deceptive business practice. PLE is not responsible for any such statements.

### Contacting Pletronics Inc.

Pletronics Inc.  
19013 36<sup>th</sup> Ave. West  
Lynnwood, WA 98036-5761 USA

Tel: 425-776-1880  
Fax: 425-776-2760  
E-mail: [ple-sales@pletronics.com](mailto:ple-sales@pletronics.com)  
URL: [www.pletronics.com](http://www.pletronics.com)

Copyright © 2007, Pletronics Inc.