

Miniature Bridge Rectifiers

SKB 2

V _{RSM} V _{RRM}	V _{V RMS}	I _D (T _{amb} = 45 °C) 2,5 A		
		Types	C _{max} μF	R _{min} Ω
V	V			
200	60	SKB 2/02 L5A	3 000	1
400	125	SKB 2/04 L5A	2 200	1,5
800	250	SKB 2/08 L5A	1 000	3
1200	500	SKB 2/12 L5A	500	6

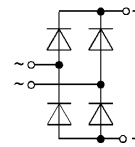
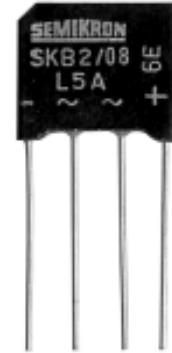

Symbol	Conditions	SKB 2
I _D	T _{amb} = 45 °C; isolated ¹⁾ chassis ²⁾	1,7 A 2,5 A
I _{DCL}	T _{amb} = 45 °C; isolated ¹⁾ chassis ²⁾	1,4 A 2 A
I _{FSM}	T _{vj} = 25 °C, 10 ms T _{vj} = 150 °C, 10 ms	58 A 50 A
i ² t	T _{vj} = 25 °C, 8,3...10 ms T _{vj} = 150 °C, 8,3...10 ms	17 A ² s 12,5 A ² s
V _F	T _{vj} = 25 °C; I _F = 10 A	1,65 V
V _(TO)	T _{vj} = 150 °C	0,85 A
r _T	T _{vj} = 150 °C	100 mΩ
I _{RD}	T _{vj} = 25 °C; V _{RD} = V _{RRM} ≤ 200 V ≥ 400 V	20 μA 5 μA
	T _{vj} = 150 °C; V _{RD} = V _{RRM} ≤ 200 V ≥ 400 V	1 mA 0,6 mA
t _{rr}	T _{vj} = 25 °C	typ. 10 μs
f _G		2000 Hz
R _{thja}	isolated ¹⁾ chassis ²⁾	30 °C/W 17,5 °C/W
T _{vj}		- 40...+ 150 °C
T _{stg}		- 55...+ 150 °C
RC	P _R = 1 W	10 nF+20...50 Ω
F _u		2 A
w		4 g
Case	→ page B 11 – 6	G 4

Features

- Compact plastic package with in-line terminals
- High blocking voltage

Typical Applications

- Internal power supplies for electronic equipment
- DC power supplies
- Control equipment
- TV sets

1) Freely suspended or mounted on an insulator
 2) Mounted on a painted metal sheet of min. 250 x 250 x 1 mm

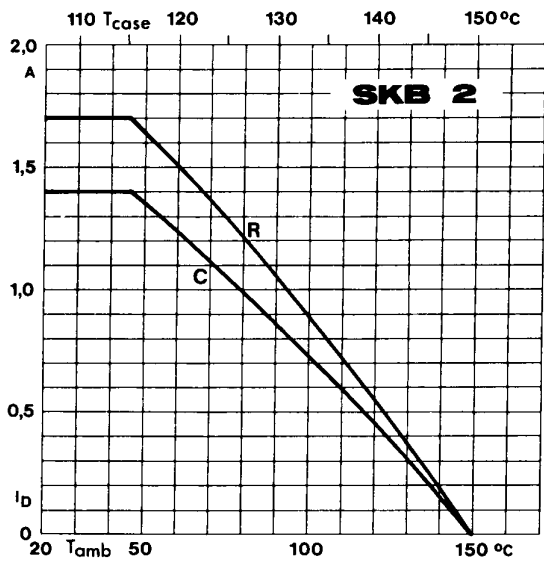

Fig. 1 Rated output current vs. ambient temperature

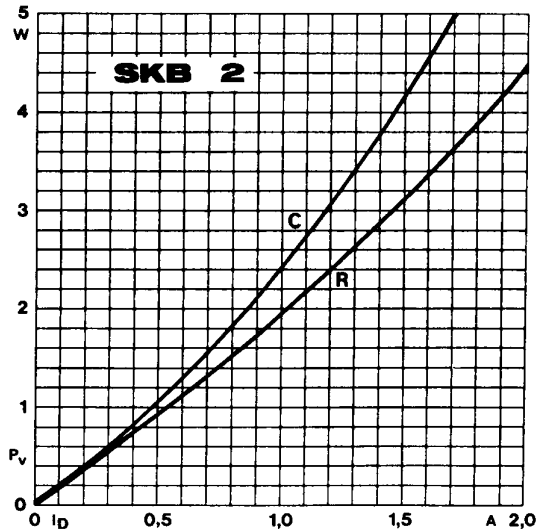

Fig. 2 Power dissipation vs. output current

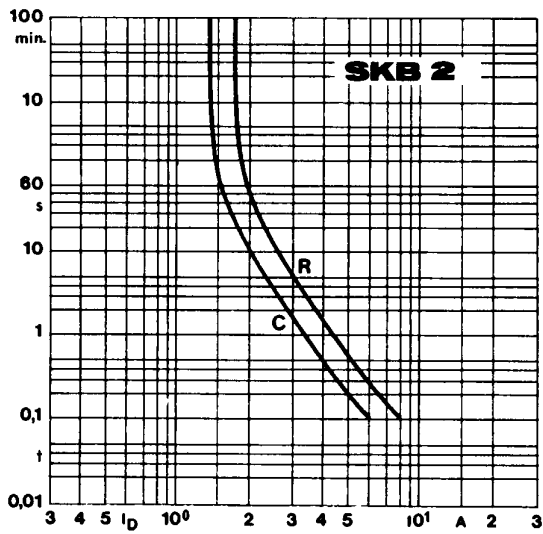

Fig. 6 Rated overload current vs. time

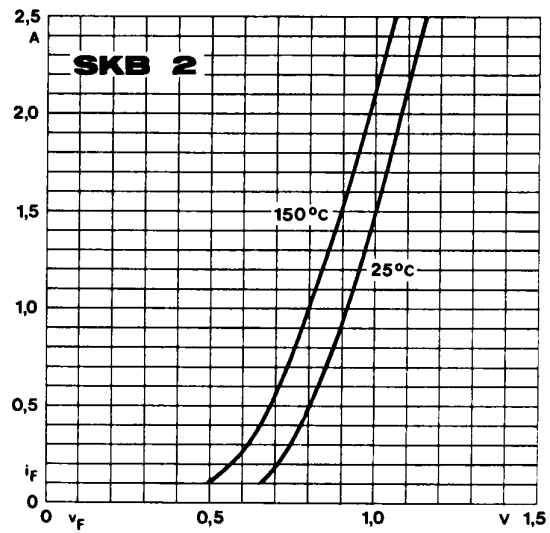
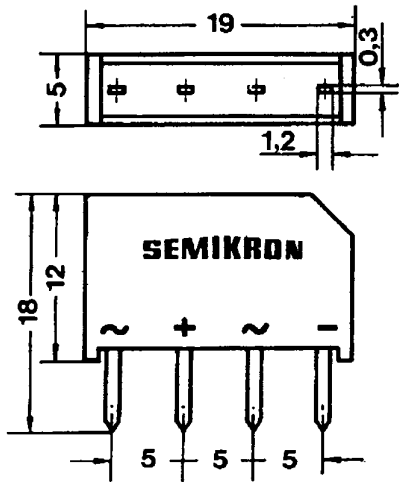
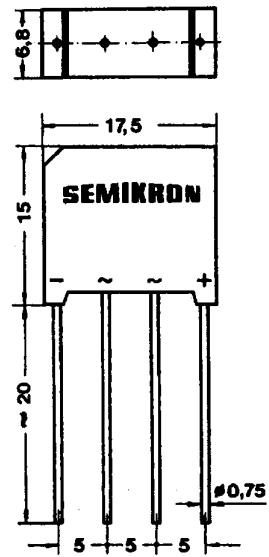

Fig. 9 Forward characteristics of a single diode

SKB B ... C 1000 L5B SKB B ... C 1500 L5B
 SKBa B 500 C 1000 L5B SKBa B 500 C 1500
 Case G 2



SKB 2
 Case G 4



Dimensions in mm