



DC-DC Converters

Mini Encapsulated - PC Board mounting

REGULATED

single & dual tracking outputs

- Shipped Within 3 Days
- One Year Warranty



Don't forget these facts about Acopian

1. We ship within 3 Days (see our 3 Day Shipping Promise)
2. Acopian Power Supplies last a long time.
3. The Voltage Finder (www.voltagefinder.com) is the quickest way to find a power supply with the specs you need.
4. The Online System Builder (www.acopian.com/SystemBuilder) is a convenient way to get your own custom Power System (and they ship within 9 Days).
5. You always talk to a real person when you call Acopian.
6. You can order your Acopian power supplies online.



Acopian Technical Company
Easton, PA

1-800-523-9478 • www.acopian.com



DC-DC Converters

Mini Encapsulated - **PC Board mounting**
REGULATED
single & dual tracking outputs

- Shipped Within 3 Days
- One-Year Warranty



These versatile DC-DC Converters are ideally suited for powering a wide variety of analog and digital circuitry, such as op amps, logic and microprocessors. They may be mounted directly on a printed circuit board for OEM applications, or installed in a socket for developmental and small quantity requirements. For DC-DC Converters with screw terminals, see pages 62 and 63.

Efficiency is in the order of 65%, and is maintained down to low levels of output current. Input reflected ripple is reduced to less than 1% by means of a standard built-in pi filter, and electrostatic shielding on all six sides minimizes radiated energy. High input/output isolation permits separation of the output from the dc input bus to minimize circuit interaction due to ground loops, and the use of inputs in either polarity.

SPECIFICATIONS

Input Voltage: Nominal voltage $\pm 10\%$.

Input Reflected Ripple: 1% E_{in} (max.)

Output Regulation:

Line: $\pm 0.02\%$

Load: $\pm 0.05\%$

Output Ripple (@ 25 MHz bandwidth):

1 mV rms, 50 mV p-p (5-15V outputs).

1.5 mV rms, 75 mV p-p (18-28V outputs).

Output Voltage Setting: Outputs are factory preset to within $\pm 1\%$ of the nominal output voltage.

T/C terminal: For single output models, the T/C terminal can be used to trim the output more precisely to the nominal voltage rating by connecting an external resistor from the T/C terminal to either the + or - terminal. For dual output models, the T/C terminal is the output common.

Polarity: The output of single output models may be connected in either polarity. Dual output models have a positive/common/negative output terminal configuration.

Transient Response (NL-FL): 50 microseconds.

Overload/Short Circuit Protection: Electronic current limiting with automatic recovery. Models in case size ELC-10 also have thermal protection with automatic reset.

Input/Output Isolation:

Voltage: 500 Vdc

Resistance: 100 megohms

Capacitance: 100 pF

Switching Frequency: 20 kHz minimum.

Temperature Coefficient: 0.02%/°C (Typical).

Ambient Operating Temperature: -20 to $+71^\circ\text{C}$.

Storage Temperature: -40 to $+85^\circ\text{C}$.

Humidity: 20% to 80% R.H. (non-condensing).

Mounting: May be mounted on printed circuit board or in socket (see page 7).

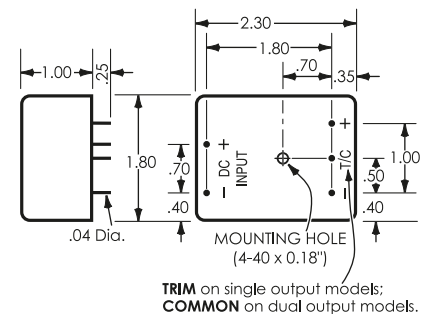

Case Size ESC-10

Approx. Weight: 5 oz.

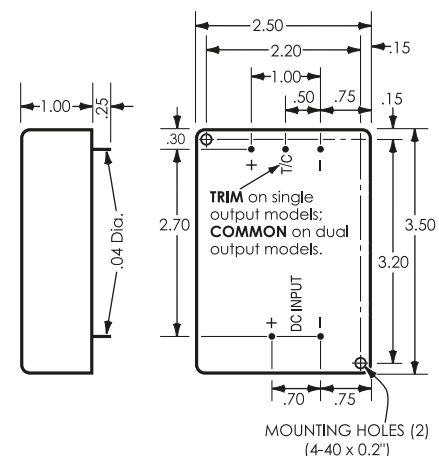

Case Size ELC-10

Approx. Weight: 12 oz.



SINGLE OUTPUT, FOR PC BOARD MOUNTING

Nominal Input Voltage	Nominal Output Voltage	Output Current Amps. at			(\$)	Model	Case Size
		40°C	55°C	71°C			
5	5	1.25	1.25	1.00	98	5E5E125	ESC-10
5	5	2.25	2.25	2.00	119	5E5E250	ELC-10
5	6	1.00	1.00	.80	98	5E6E100	ESC-10
5	6	2.00	1.80	1.60	119	5E6E200	ELC-10
5	8	.75	.75	.60	98	5E8E75	ESC-10
5	8	1.50	1.35	1.20	119	5E8E150	ELC-10
5	9	.70	.70	.55	98	5E9E70	ESC-10
5	9	1.40	1.25	1.10	119	5E9E140	ELC-10
5	10	.65	.65	.50	98	5E10E65	ESC-10
5	10	1.30	1.15	1.00	119	5E10E130	ELC-10
5	12	.60	.60	.50	98	5E12E60	ESC-10
5	12	1.20	1.10	1.00	119	5E12E120	ELC-10
5	13	.55	.55	.45	98	5E13E55	ESC-10
5	13	1.10	1.00	.90	119	5E13E110	ELC-10
5	15	.50	.50	.40	98	5E15E50	ESC-10
5	15	1.00	.90	.80	119	5E15E100	ELC-10
5	18	.40	.40	.30	98	5E18E40	ESC-10
5	18	.80	.70	.60	119	5E18E80	ELC-10
5	20	.35	.35	.28	98	5E20E35	ESC-10
5	20	.70	.60	.50	119	5E20E70	ELC-10
5	24	.25	.25	.20	98	5E24E25	ESC-10
5	24	.60	.55	.50	119	5E24E60	ELC-10
5	28	.25	.25	.20	98	5E28E25	ESC-10
5	28	.50	.45	.40	119	5E28E50	ELC-10
12	5	1.25	1.25	1.00	98	12E5E125	ESC-10
12	5	2.50	2.25	2.00	119	12E5E250	ELC-10
12	6	1.00	1.00	.80	98	12E6E100	ESC-10
12	6	2.00	1.80	1.60	119	12E6E200	ELC-10
12	8	.75	.75	.60	98	12E8E75	ESC-10
12	8	1.50	1.35	1.20	119	12E8E150	ELC-10
12	9	.70	.70	.55	98	12E9E70	ESC-10
12	9	1.40	1.25	1.10	119	12E9E140	ELC-10
12	10	.65	.65	.50	98	12E10E65	ESC-10
12	10	1.30	1.15	1.00	119	12E10E130	ELC-10
12	12	.60	.60	.50	98	12E12E60	ESC-10
12	12	1.20	1.10	1.00	119	12E12E120	ELC-10
12	13	.55	.55	.45	98	12E13E55	ESC-10
12	13	1.10	1.00	.90	119	12E13E110	ELC-10
12	15	.50	.50	.40	98	12E15E50	ESC-10
12	15	1.00	.90	.80	119	12E15E100	ELC-10
12	18	.40	.40	.30	98	12E18E40	ESC-10
12	18	.80	.70	.60	119	12E18E80	ELC-10
12	20	.35	.35	.28	98	12E20E35	ESC-10
12	20	.70	.60	.50	119	12E20E70	ELC-10
12	24	.25	.25	.20	98	12E24E25	ESC-10
12	24	.60	.55	.50	119	12E24E60	ELC-10
12	28	.25	.25	.20	98	12E28E25	ESC-10
12	28	.50	.45	.40	119	12E28E50	ELC-10
15	5	1.25	1.25	1.00	98	15E5E125	ESC-10
15	5	2.50	2.25	2.00	119	15E5E250	ELC-10
15	6	1.00	1.00	.80	98	15E6E100	ESC-10
15	6	2.00	1.80	1.60	119	15E6E200	ELC-10
15	8	.75	.75	.60	98	15E8E75	ESC-10
15	8	1.50	1.35	1.20	119	15E8E150	ELC-10
15	9	.70	.70	.55	98	15E9E70	ESC-10
15	9	1.40	1.25	1.10	119	15E9E140	ELC-10
15	10	.65	.65	.50	98	15E10E65	ESC-10
15	10	1.30	1.15	1.00	119	15E10E130	ELC-10
15	12	.60	.60	.50	98	15E12E60	ESC-10
15	12	1.20	1.10	1.00	119	15E12E120	ELC-10
15	13	.55	.55	.45	98	15E13E55	ESC-10
15	13	1.10	1.00	.90	119	15E13E110	ELC-10
15	15	.50	.50	.40	98	15E15E50	ESC-10
15	15	1.00	.90	.80	119	15E15E100	ELC-10
15	18	.40	.40	.30	98	15E18E40	ESC-10
15	18	.80	.70	.60	119	15E18E80	ELC-10

Nominal Input Voltage	Nominal Output Voltage	Output Current Amps. at			(\$)	Model	Case Size
		40°C	55°C	71°C			
15	20	.35	.35	.28	98	15E20E35	ESC-10
15	20	.70	.60	.50	119	15E20E70	ELC-10
15	24	.25	.25	.20	98	15E24E25	ESC-10
15	24	.60	.55	.50	119	15E24E60	ELC-10
15	28	.25	.25	.20	98	15E28E25	ESC-10
15	28	.50	.45	.40	119	15E28E50	ELC-10
24	5	1.25	1.25	1.00	98	24E5E125	ESC-10
24	5	2.50	2.25	2.00	119	24E5E250	ELC-10
24	6	1.00	1.00	.80	98	24E6E100	ESC-10
24	6	2.00	1.80	1.60	119	24E6E200	ELC-10
24	8	.75	.75	.60	98	24E8E75	ESC-10
24	8	1.50	1.35	1.20	119	24E8E150	ELC-10
24	9	.70	.70	.55	98	24E9E70	ESC-10
24	9	1.40	1.25	1.10	119	24E9E140	ELC-10
24	10	.65	.65	.50	98	24E10E65	ESC-10
24	10	1.30	1.15	1.00	119	24E10E130	ELC-10
24	12	.60	.60	.50	98	24E12E60	ESC-10
24	12	1.20	1.10	1.00	119	24E12E120	ELC-10
24	13	.55	.55	.45	98	24E13E55	ESC-10
24	13	1.10	1.00	.90	119	24E13E110	ELC-10
24	15	.50	.50	.40	98	24E15E50	ESC-10
24	15	1.00	.90	.80	119	24E15E100	ELC-10
24	18	.40	.40	.30	98	24E18E40	ESC-10
24	18	.80	.70	.60	119	24E18E80	ELC-10
24	20	.35	.35	.28	98	24E20E35	ESC-10
24	20	.70	.60	.50	119	24E20E70	ELC-10
24	24	.25	.25	.20	98	24E24E25	ESC-10
24	24	.60	.55	.50	119	24E24E60	ELC-10
24	28	.25	.25	.20	98	24E28E25	ESC-10
24	28	.50	.45	.40	119	24E28E50	ELC-10
28	5	1.25	1.25	1.00	98	28E5E125	ESC-10
28	5	2.50	2.25	2.00	119	28E5E250	ELC-10
28	6	1.00	1.00	.80	98	28E6E100	ESC-10
28	6	2.00	1.80	1.60	119	28E6E200	ELC-10
28	8	.75	.75	.60	98	28E8E75	ESC-10
28	8	1.50	1.35	1.20	119	28E8E150	ELC-10
28	9	.70	.70	.55	98	28E9E70	ESC-10
28	9	1.40	1.25	1.10	119	28E9E140	ELC-10
28	10	.65	.65	.50	98	28E10E65	ESC-10
28	10	1.30	1.15	1.00	119	28E10E130	ELC-10
28	12	.60	.60	.50	98	28E12E60	ESC-10
28	12	1.20	1.10	1.00	119	28E12E120	ELC-10
28	13	.55	.55	.45	98	28E13E55	ESC-10
28	13	1.10	1.00	.90	119	28E13E110	ELC-10
28	15	.50	.50	.40	98	28E15E50	ESC-10
28	15	1.00	.90	.80	119	28E15E100	ELC-10
28	18	.40	.40	.30	98	28E18E40	ESC-10
28	18	.80	.70	.60	119	28E18E80	ELC-10
28	20	.35	.35	.28	98	28E20E35	ESC-10
28	20	.70	.60	.50	119	28E20E70	ELC-10
28	24	.25	.25	.20	98	28E24E25	ESC-10
28	24	.60	.55	.50	119	28E24E60	ELC-10
28	28	.25	.25	.20	98	28E28E25	ESC-10
28	28	.50	.45	.40	119	28E28E50	ELC-10
48	5	1.25	1.25	1.00	98	48E5E125	ESC-10
48	6	1.00	1.00	.80	98	48E6E100	ESC-10
48	8	.75	.75	.60	98	48E8E75	ESC-10
48	9	.70	.70	.55	98	48E9E70	ESC-10
48	10	.65	.65	.50	98	48E10E65	ESC-10
48	12	.60	.60	.50	98	48E12E60	ESC-10
48	13	.55	.55	.45	98	48E13E55	ESC-10
48	15	.50	.50	.40	98	48E15E50	ESC-10
48	18	.40	.40	.30	98	48E18E40	ESC-10
48	20	.35	.35	.28	98	48E20E35	ESC-10
48	24	.25	.25	.20	98	48E24E25	ESC-10
48	28	.25	.25	.20	98	48E28E25	ESC-10

120 to 180 See pages 10 - 11.

DUAL TRACKING OUTPUTS

Nominal Input Voltage	Nominal Output Voltages	Amps. per Output at			(\$)	Model	Case Size
		40°C	55°C	71°C			
5	±10	.30	.30	.25	105	5E10D30	ESC-10
5	±10	.60	.55	.50	125	5E10D60	ELC-10
5	±12	.30	.30	.25	105	5E12D30	ESC-10
5	±12	.60	.55	.50	125	5E12D60	ELC-10
5	±15	.25	.25	.25	105	5E15D25	ESC-10
5	±15	.50	.45	.40	125	5E15D50	ELC-10
5	±18	.20	.20	.20	105	5E18D20	ESC-10
5	±18	.40	.35	.30	125	5E18D40	ELC-10
12	±10	.30	.30	.25	105	12E10D30	ESC-10
12	±10	.60	.55	.50	125	12E10D60	ELC-10
12	±12	.30	.30	.25	105	12E12D30	ESC-10
12	±12	.60	.55	.50	125	12E12D60	ELC-10
12	±15	.25	.25	.25	105	12E15D25	ESC-10
12	±15	.50	.45	.40	125	12E15D50	ELC-10
12	±18	.20	.20	.20	105	12E18D20	ESC-10
12	±18	.40	.35	.30	125	12E18D40	ELC-10
15	±10	.30	.30	.25	105	15E10D30	ESC-10
15	±10	.60	.55	.50	125	15E10D60	ELC-10
15	±12	.30	.30	.25	105	15E12D30	ESC-10
15	±12	.60	.55	.50	125	15E12D60	ELC-10
15	±15	.25	.25	.25	105	15E15D25	ESC-10
15	±15	.50	.45	.40	125	15E15D50	ELC-10

Nominal Input Voltage	Nominal Output Voltages	Amps. per Output at			(\$)	Model	Case Size
		40°C	55°C	71°C			
15	±18	.20	.20	.20	105	15E18D20	ESC-10
15	±18	.40	.35	.30	125	15E18D40	ELC-10
24	±10	.30	.30	.25	105	24E10D30	ESC-10
24	±10	.60	.55	.50	125	24E10D60	ELC-10
24	±12	.30	.30	.25	105	24E12D30	ESC-10
24	±12	.60	.55	.50	125	24E12D60	ELC-10
24	±15	.25	.25	.25	105	24E15D25	ESC-10
24	±15	.50	.45	.40	125	24E15D50	ELC-10
24	±18						

ACCESSORY SOCKETS

For use with PC board mounting Mini Linears and PC board mounting DC-DC Converters.
Each of these sockets has a sturdy phenolic base with gold plated teflon-insulated contacts.

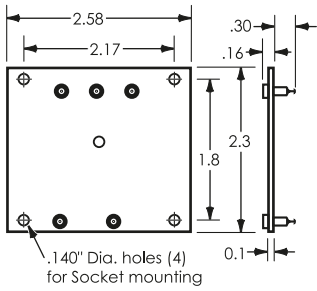

(for case sizes ES-10 and ESC-10)

Model ES-1.....\$20

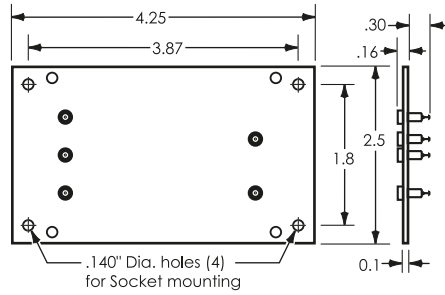

(for case sizes EL-10, EL-13, EL-20 and ELC-10)

Model EL-1.....\$20

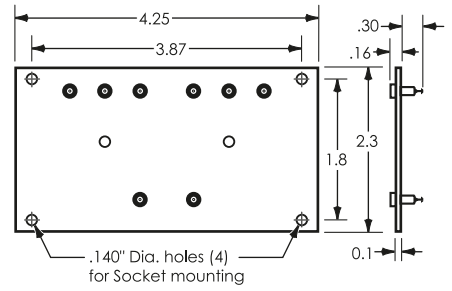

(for case size END)

Model END-1.....\$20



The complete Acopian catalog is also available on the Internet at www.acopian.com
P.O. Box 638, Easton, PA 18044 • Phone: (610) 258-5441 • FAX: (610) 258-2842

Acopian

... can expedite your order, if 3 DAYS isn't fast enough

In 1964 Acopian initiated its "3 Day Shipping Guarantee"(see below). Since then our product offerings have expanded to include many more lines of power supplies that ship within 3 Days as well as others that ship within 6 or 9 Days. These guarantees apply to every model in the Acopian catalog.

If you require shipment even earlier than our standard promise, just let us know, we can usually ship sooner. We welcome the opportunity to work with you.

About Acopian's 3 Day Shipment Guarantee:

Our unique 3-day shipping guarantee has prompted many questions. Below are some of those most often asked:

What does Acopian's 3-day shipping promise mean?

It means that power modules listed in our catalog are shipped within 3 days after we receive your order. High Voltage, Redundant, Rack Mounting, Systems and certain Switching power supplies are shipped within 9 days.

Has Acopian ever failed to meet this promise?

Never.

Do options affect shipping time?

The 230 volt input option and moisture/fungus-proofing option require two additional days. All other options do not affect shipping time.

Is the 3-day promise affected by quantity? Suppose we need 50 or 100 pieces?

The 3-day promise applies to orders for five or less modules. (Two or less for 9-day items). If requested, Acopian will ship five pieces of a larger order in 3 days and, with consideration of your requirement, schedule the balance. (Since each shipment is processed and priced as a separate order, for lowest prices request shipment in one lot.)

What if I need four or five different models? Does the 3-day promise still apply?

Yes. Guaranteed 3-day shipment applies to one model or to a combination of models.

Do I have to ask for 3-day shipment of my order?

3-day shipment is automatic. In fact, you must tell us if you want the shipment delayed.

How long after you ship will I have the power supplies?

Transportation time varies with the carrier used. Unless otherwise requested, Acopian ships small orders by UPS Ground.

You say Acopian has never failed to meet the 3-day promise. How do you do it?

Our facilities have been designed and equipped to meet our 3-day shipment promise. When your order is received, your power supplies are built specifically for you and shipped within three days. We do not ship from stock. (For this reason we are unable to accept returns for credit.)

I've seen other power supply manufacturers advertise "same day shipment". Isn't that better than 3-day shipment?

A typical vendor's "same day shipment" advertisement can only be fulfilled if the power supplies you need are in stock. Otherwise, a four to six week delay is not unusual before inventory is replenished and your order is shipped.

Acopian's 3-day shipment promise applies to ALL 3 Day models (larger units ship within 9 Days) and is not dependent on the quantity in stock. We build each unit after the order for that unit is received. If an order is needed faster, often times we can ship in less than 3 days.



The complete Acopian catalog is also available on the Internet at www.acopian.com
P.O. Box 638, Easton, PA 18044 • Phone: (610) 258-5441 • FAX: (610) 258-2842

Acopian

...answers your phone call with a live salesperson

No automated menus. The person who answers your call will courteously and promptly answer your questions, quote price and delivery, expedite your urgent requirements, and offer you immediate access to our engineers. Call toll free 800-523-9478.

...can expedite shipment for you

If you require a power supply shipment earlier than our standard 3 or 9 Day Promise, we can usually ship sooner. We welcome the opportunity to work with you.

...can customize power supplies for you

If a standard power supply does not meet all of your requirements, speak with one of our engineers. We can often modify the specifications, ratings and configuration of a supply. We can also combine several power supplies into a Multiple Output Power System with the operating features you specify (such as meters and switches) and ship it within 9 Days!

...has a 5-year warranty

One of our customers sent us an old power supply with a note indicating that the supply had been in continuous use since 1972 (33 years!), but he had recently noticed that the output voltage was low. We found that the capacitors had dried up, replaced them and returned the supply to the customer, who thanked us and said he intends to keep using it.

We focus on making power supplies that will last a long time. There are power supplies that cost less than ours, or that are smaller than ours, but you won't find any that last longer than ours. All too often, low-priced supplies are densely packed, run hot, have short lifetimes and short warranties.

All Acopian metal-cased power products have a 5-year warranty, but you can expect them to last a lot longer.

**Purchase Acopian... long lasting power supplies
and unsurpassed customer service**



The complete Acopian catalog is also available on the Internet at www.acopian.com
P.O. Box 638, Easton, PA 18044 • Phone: (610) 258-5441 • FAX: (610) 258-2842

ORDERING INFORMATION & Terms and Conditions

ACOPIAN SELLS FACTORY DIRECT WORLDWIDE: We do not use representatives or distributors. Contact Acopian for technical information or a quote.

WARRANTY: Acopian power supplies are warranted to be free from defects in material and workmanship for a period of five years (encapsulated devices and fans, for one year) from date of original shipment. Acopian's obligation under this warranty is limited to repairing any power supply returned to the factory Service Department in Easton, PA and replacing any defective parts. Mini Encapsulated power supplies are not repairable. Authorization must be obtained from Acopian before a power supply may be returned for repair. Units must be well packed when shipping to Acopian; the repair of any damage incurred during shipment will be charged. Transportation charges are to be paid by the purchaser. A reinspection and handling charge will be applied to returned units found to have no defects. If a failure has been caused by misuse, operation in excess of specifications, or modification by the customer, repairs will be billed at cost; in such cases, a cost estimate will be submitted before work is started.

Acopian reserves the right to make changes or improvements in its products without incurring any obligation to install the same on products previously manufactured.

This warranty is in lieu of all other warranties, obligations, and liabilities, expressed or implied, and is the purchaser's exclusive remedy. Acopian makes no warranty, either express or implied, of merchantability, fitness for a particular purpose or otherwise. In no event shall Acopian be liable whether in contract, tort, or negligence, for special, indirect, incidental or consequential damages of any kind, including loss of business or profits, or any other losses incurred by the purchaser or any third party, the Customer's remedies being limited, at Acopian's option, to replacement, repair or credit at the price on the date of claim.

The validity, performance and construction of all terms and conditions and any sale made by Acopian shall be determined by the law of Pennsylvania, without regard to its conflict of law principles, and all parties to the transaction expressly consent to the jurisdiction of such courts and consent to the venue of the Court of Common Pleas for Northampton County, Pennsylvania.

PRICES: The prices shown are F.O.B. our factory; Easton, PA. or Melbourne, FL.. All prices and specifications are subject to change without notice. Minimum order is \$50.00.

TERMS: Net 30 days, subject to credit approval. Visa, MasterCard, and American Express are also accepted.

SHIPPING: Location permitting, small shipments are made by United Parcel Service, or by Parcel Post; larger shipments, by insured motor freight collect. Shipments can be made by air upon request. Risk of loss shall be F.O.B. Our Factory, even in cases where freight may be prepaid or allowed to destination by Acopian. If equipment is received in damaged condition, it is the customer's responsibility to contact the carrier and file a claim for damages.

TIME FOR DELIVERY: The time for delivery quoted by Acopian is the time required to ship from our plants. We will not be liable for delays in delivery caused by any reason beyond our control, including but not limited to acts of God, casualty, civil disturbance, labor disputes, transportation or supply difficulties, or any interruption of our facilities, and the quoted time for delivery shall be extended during the continuance of such conditions and for a reasonable time thereafter. In no event will Acopian be liable for any premium transportation, procurement, or similar costs incurred by the Customer as a result of conditions beyond Acopian's control resulting in Acopian's inability to deliver product in accordance with customer's requested delivery schedules.

QUANTITY DISCOUNTS: Discounts are available to quantity buyers and are dependent upon the order quantity and the manufacturing scheduling anticipated by the order, and apply only to the quantity and delivery ordered. Partial shipments are considered as separate orders for discounting purposes.

EXPORT ORDERS: A minimum export documentation charge of \$60.00 applies. (A minimum charge of \$25.00 applies on orders requiring customs forms for Canadian orders and for orders to certain U.S. territories.)

MOISTURE/FUNGUS PROOFING: Power supplies can be furnished with a moisture and fungus resistant varnish applied to interior surfaces. To order, add the suffix letter F to the model number. The additional cost is \$25.00 per output and requires two additional days. Not available on High Voltage, Switching, Mini Encapsulated and Rack Mounting models.

TAGGING: Maximum of 15 characters/spaces. Add \$10.00 to price.

TEST DATA: Cost, \$35.00 or 2% of order, whichever is greater.

SPECIAL MODELS/MODIFICATIONS: Cataloged models can be altered at the factory to meet special requirements. Contact the Applications Engineering Department to discuss your needs.

PARTS: The designs used in Acopian power supplies utilize standard components to the greatest practical extent. When replacements are required, the types originally used, or their equivalents, can usually be obtained most quickly from a local electronic components distributor.

Special components, such as transformers, are stocked at the factory warehouses. Contact the Applications Engineering Department for information on the parts required, referencing the model number of the power supply, the circuit designation of the component, and a description.

PURCHASE ORDER ACCEPTANCE: Orders are accepted subject to Acopian's Terms and Conditions. Any Terms and Conditions of any Purchaser's order, agreement, or understanding which are in addition to or inconsistent with Acopian's shall not be binding upon Acopian unless made in writing and accepted over the signature of an authorized officer of Acopian. Orders shall not be considered accepted until entered into production at our plant. Acopian reserves the right to refuse any order. All typographical and clerical errors are subject to correction by Acopian.

RETURNED GOODS: Acopian products are built on a per-order basis, and ordinarily no credit can be extended for their return. No goods will be accepted for return unless authorized in writing by Acopian.

CHANGES: The customer may, by a written notice, request changes within the general scope of the order, in the drawings, designs or specifications; method of shipment; and place of delivery. If any such change causes an increase or decrease in the cost, or the time required for the processing of any part of the order, an equitable adjustment shall be made in the price or delivery schedule, or both, and the order shall be modified in writing accordingly.

CANCELLATION: Suspension or cancellation of orders may be made only upon our written approval and on terms that will indemnify us against all loss.

OVERTIME: It is anticipated that any order will be processed during regular working hours on regular working days. If for any reason the Purchaser requests Acopian to process the order, or any portion of it, outside of such regular working hours, any overtime or other additional expense occasioned thereby shall be billed to and paid by the Purchaser as an extra cost. Acopian reserves the right to decline to process the order outside regular working hours.

CUSTOMER DELAY OF WORK: If the performance of all or any part of the work is delayed or interrupted by Customer's failure to act within the time specified (or within a reasonable time if no time is specified) and such act is not expressed or implied by the order, an adjustment shall be made in the cost of performance of the order caused by such delay or interruption and the order modified in writing accordingly. Adjustment will also be made in the delivery or performance dates and any other contractual provisions affected by such delay or interruption.

GOVERNMENT SPECIFICATIONS: Pricing is based upon industrial-grade construction, marking, packing, and packaging. Exception is taken to any MIL specifications, and to any requirements for the use of special forms, documentation other than quoted, and Government Source Inspection. Acopian must decline to quote on any other basis.

APPLICATIONS ASSISTANCE: *Questions regarding the specifications, features, and use of any Acopian product should be directed to the Applications Engineering Department. A staff of power supply specialists will be pleased to assist you.*

At www.acopian.com you will find: This complete catalog in an easy-to-use format • CAD drawings • Instruction sheets



Since 1957

Acopian Technical Company
P.O. Box 638, Easton, PA 18044 • Phone: (610) 258-5441 • FAX: (610) 258-2842
Call toll free: (800) 523-9478 (International: Country Code 01)

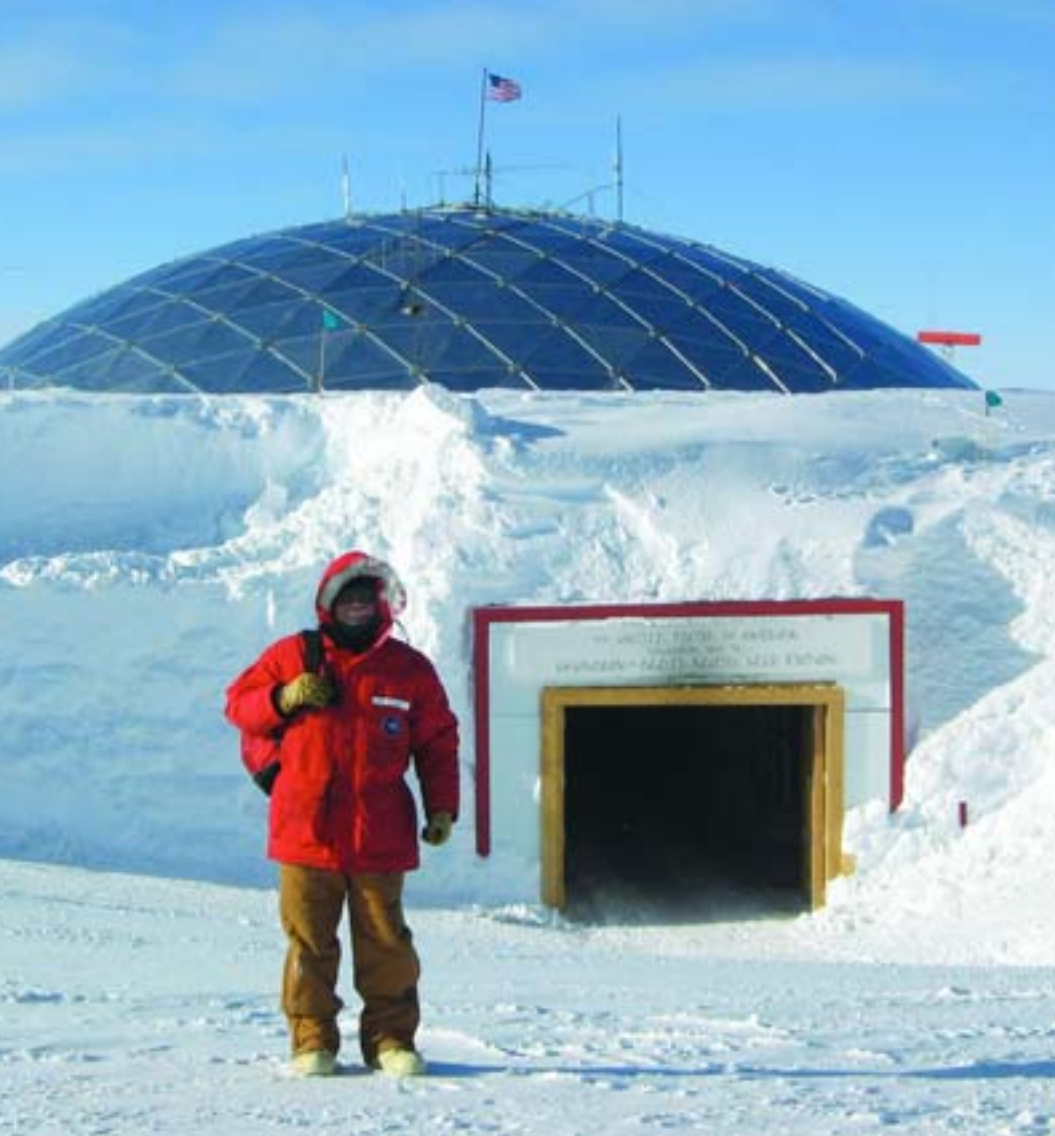

PHOTO COURTESY OF THE ICECUBE PROJECT

“At Project IceCube, it’s absolutely critical to have a good power supply.

*The ice must be as pure and clear as possible. If the power to the ice top sensor system were to fail, we would risk the tank water freezing without being controlled, resulting in bubbles and impurities, and very much reducing the quality of ice and quality of information that we can see with our detectors. **We chose Acopian power supplies to power our pumping and degassing systems because of their reputation for reliability.** The people at Acopian met all of our highly demanding specifications and, despite very little time until our window to ship to the Pole, they met our schedule.*

We were 100% satisfied.”

Jim Baccus
Cable System Manager
Project IceCube

(the international high-energy neutrino observatory being built and installed in the ice below South Pole Station)

The world’s most demanding environments demand Acopian power systems.

Simply call Acopian today and talk to one of our expert power systems designers about your requirements, or use the online **System Builder** at www.acopian.com.

We’ll provide you with a detailed description of the ideal, built-to-order multiple output power system to suit your needs – plus, a very competitive

price. Your completely assembled, wired and tested power system will be shipped within nine working days. Or visit acopian.com for instant, easy access to thousands of individual power modules. Choose Acopian – the power supplies of choice for the world’s leading engineers. Call today!



ALL ACOPIAN POWER SUPPLIES
MADE IN U.S.A.

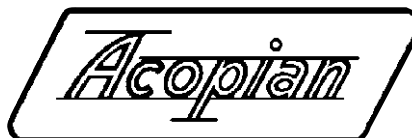

Acopian Technical Company

1-800-523-9478 • www.acopian.com