

Product Family Specification



CMA3000-D0X Series
3-axis accelerometer

TABLE OF CONTENTS

1	General Description	5
1.1	Introduction	5
1.2	Functional Description	5
1.2.1	Sensing element.....	5
1.2.2	Interface IC.....	5
1.2.3	Factory calibration	5
1.2.4	Supported features	6
1.2.5	Operation modes.....	6
1.2.5.1	Power Down	6
1.2.5.2	Measurement.....	6
1.2.5.3	Motion Detection.....	6
1.2.5.4	Free-Fall Detection	6
1.2.6	Interrupt.....	6
1.2.7	Operational flow chart	7
2	Reset and power up, Operation Modes, HW functions and Clock.....	8
2.1	Reset and power up.....	8
2.2	Power Down mode.....	8
2.3	Measurement Mode	8
2.3.1	Description.....	8
2.3.2	Usage.....	8
2.4	Motion Detection Mode	8
2.4.1	Description.....	8
2.4.2	Usage.....	9
2.4.3	Example.....	10
2.5	Free-Fall Detection.....	10
2.5.1	Description.....	10
2.5.2	Usage.....	10
2.5.3	Example.....	10
2.6	Interrupt function (INT-pin)	11
2.6.1	Usage.....	11
2.7	Clock	11
3	Addressing Space	12
3.1	Register Description.....	12
3.2	Non-volatile memory	12
3.3	Registers.....	12
4	Serial Interfaces	17
4.1	SPI Interface	17

4.1.1	SPI frame format.....	17
4.1.2	Examples of SPI communication.....	18
4.1.2.1	Example of register read.....	18
4.1.3	Multiple slave devices in SPI bus	18
4.2	I ² C Interface	19
4.2.1	I ² C frame format.....	19
4.2.1.1	I ² C write mode.....	19
4.2.1.2	I ² C read mode.....	19
4.2.2	Examples of I ² C communication.....	19
5	Electrical Characteristics	20
5.1	Absolute maximum ratings.....	20
5.2	Power Supply	20
5.3	Digital I/O Specification.....	20
5.3.1	Digital I/O DC characteristics	20
5.3.2	Digital I/O level shifter.....	20
5.3.3	SPI AC characteristics	21
5.3.4	I ² C AC characteristics	21
6	Package Characteristics.....	22
6.1	Dimensions.....	22
7	Application information	23
7.1	Pin Description.....	23
7.2	Recommended circuit diagram	23
7.3	Recommended PWB layout	24
7.4	Mounting recommendations.....	24
7.5	Assembly instructions	25
7.6	Tape and reel specifications.....	25
8	Data sheet references	26
8.1	Offset.....	26
8.1.1	Offset calibration error	26
8.1.2	Offset temperature error.....	26
8.2	Sensitivity	26
8.2.1	Sensitivity calibration error.....	27
8.2.2	Sensitivity temperature error	27
8.3	Linearity	27
8.4	Noise	28
8.5	Bandwidth.....	29
8.6	Cross-axis sensitivity	29

8.7 Turn-on time.....30

9 Known issues 31

9.1 Acceleration data reading via I²C bus.....31

9.1.1 Interrupt based acceleration reading31

9.1.2 Acceleration reading without interrupts32

9.2 Leakage current when VDD - DVIO > 0.3 V32

10 Order Information..... 33

11 Document Change Control..... 34

12 Contact Information 35

1 General Description

1.1 Introduction

CMA3000-D0X is a three axis accelerometer family targeted for high volume products requiring small size, low price and low power consumption. It consists of a 3D-MEMS sensing element and a signal conditioning ASIC in a wafer level package.

Block diagram of CMA3000-D0X is shown in Figure 1 below.

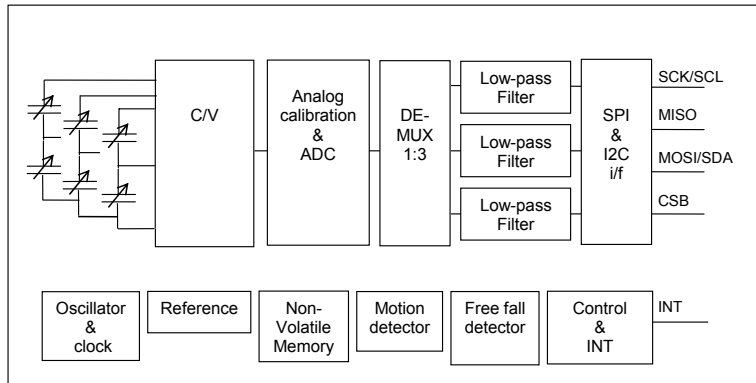

Figure 1. CMA3000-D0X block diagram with digital SPI and I²C interface

This document, no. 8281000, describes the product specification (e.g. operation modes, user accessible registers, electrical properties and application information) for the CMA3000-D0X family. The specification for an individual sensor is available in the corresponding data sheet.

1.2 Functional Description

1.2.1 Sensing element

The sensing element is manufactured using proprietary bulk 3D-MEMS process, which enables robust, stable and low noise & power capacitive sensors.

The sensing element consists of three acceleration sensitive masses. Acceleration will cause a capacitance change that will be then converted into a voltage change in the signal conditioning ASIC.

1.2.2 Interface IC

CMA3000 includes an internal oscillator, reference and non-volatile memory that enable the sensor's autonomous operation within a system.

The sensing element is interfaced via a capacitance-to-voltage (CV) converter. Following calibration in the analog domain, the signal is A/D-converted and then digitally filtered. Sensor output is user selectable digital SPI or I²C interface.

In measurement mode acceleration data can be read via the serial bus and in power down mode the device is in-active. Other supported features are motion and free-fall detection. In these modes, the sensor will generate an interrupt when a pre-defined condition has been met. Measurement range can be selected by register command.

1.2.3 Factory calibration

Sensors are factory calibrated. Trimmed parameters are gain, offset, internal current reference and frequency of the internal oscillator. Calibration parameters will be read automatically from the internal non-volatile memory during sensor startup.

1.2.4 Supported features

Supported features are listed in Table 1 below.

Table 1. CMA3000-D0X devices' summary.

Features	CMA3000-D01
Supply voltage	1.7 V – 3.6 V
I/O voltage	1.7 V – 3.6 V
Measuring range (selectable)	±2 g, ±8 g
Resolution (2g /8g range)	17 mg / 67 mg
Sensitivity (2g /8g range)	56 counts/g / 14 counts/g
Motion detection	User enabled
Free fall detection	User enabled
Interface	SPI max 500 kHz, I ² C fast mode 400 kHz
Clock	Internal

1.2.5 Operation modes

1.2.5.1 Power Down

In Power Down (PD) mode device's volatile register keep their contents and the current consumption is minimized. Power down mode is the default mode after start up.

1.2.5.2 Measurement

In Measurement mode (Meas) the sensor offers acceleration information via the digital SPI/I²C interface. Interrupt can be activated via INT-pin, when each xyz-acceleration sample is ready to be read.

Measurement range and sample rate are user selectable according to Table 2. Measurement mode can be activated by detected motion.

1.2.5.3 Motion Detection

Motion Detection (MD) mode is intended to be used to save system level power consumption. In this mode, CMA3000-D0X activates the interrupt via the INT-pin when motion is detected. Motion sensitivity level can be configured via the SPI or I²C bus. Moreover, duration of the motion to be detected can be user defined. Once the interrupt has happened, the detected direction can be read out from the corresponding status register.

Low sample rate (10 Hz) band-pass filtered acceleration information is available in MD mode. The device can be configured to switch automatically into the measurement mode with highest sampling rate after motion detection.

1.2.5.4 Free-Fall Detection

Free-Fall Detection (FFD) is intended to be used to save system resources. This feature activates the interrupt via the INT-pin when free-fall is detected. Acceleration information is available when the FFD is enabled.

1.2.6 Interrupt

The CMA3000 has a dedicated output pin (INT) to be used as the interrupt for the master controller. Interrupt conditions can be activated and deactivated via the SPI or I²C bus. Once the interrupt has happened, the interrupt source can be read out from the corresponding status register.

1.2.7 Operational flow chart

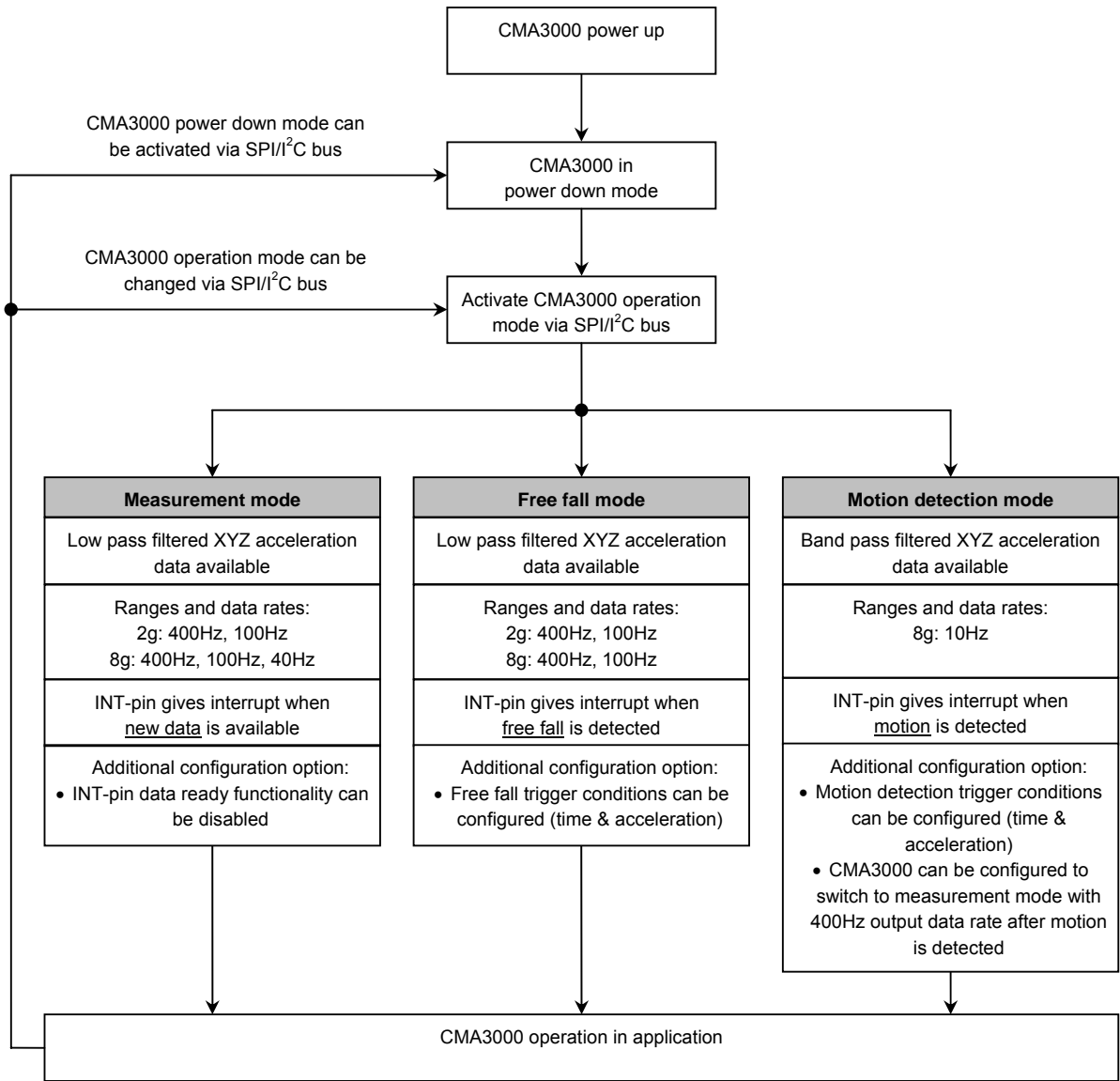

Figure 2. CMA3000 operational flow chart.

2 Reset and power up, Operation Modes, HW functions and Clock

2.1 Reset and power up

The CMA3000 has internal power-on reset circuit. It releases the internal reset-signal once the power supplies will be within the specified range.

After releasing the internal reset, the CMA3000 will read configuration and calibration data from the non-volatile memory to volatile registers. Then the CMA3000 will make parity check to the read memory content. The STATUS register's PERR-bit="0" shows successful memory read operation.

Device can be externally reset by writing the sequence 02h, 0Ah, 04h into the RSTR-register.

2.2 Power Down mode

The CMA3000-D0X enters the power down mode by default after power-on reset and initialization of the volatile registers. PD can also be set by writing MODE[2:0] = 000b (or MODE[2:0] = 111b) to CTRL register.

Output registers will keep their content in the power down mode.

2.3 Measurement Mode

2.3.1 Description

The CMA3000-D0X is set to a measurement mode by writing MODE[2:0] = 0XXb to CTRL register. Data will be reliable in the output registers after the product specific turn-on time.

Default sample rate is 400 Hz (MODE[2:0] = 010b). Other data rates are 100 Hz (MODE[2:0] = 001b) and 40 Hz (MODE[2:0] = 011b).

Table 2. CMA3000-D0X measurement ranges and output sample rates

Measurement range	Output sample rates
2 g	400 Hz, 100 Hz
8 g	400 Hz, 100 Hz, 40 Hz

INT-pin gives an interrupt by default when new data is available.

2.3.2 Usage

Acceleration data can be read from data output registers DOUTX, DOUTY and DOUTZ. See section 2.6 for INT-pin configuration details.

2.4 Motion Detection Mode

2.4.1 Description

In MD mode the device works at 10 Hz sample rate and the fixed measurement range is 8 g. Signal is band pass filtered and fed to threshold level programmable digital comparator and a configurable trigger function. Filtered signal is also available at output registers.

The device can be configured to switch automatically into the measurement mode with highest sampling rate (400Hz) after motion is detected. The measurement range used will be defined by G_RANGE bit.

Nominal BPF's -3 dB high-pass frequency is 1.3 Hz and -3 dB low-pass frequency is 3.8 Hz. See Figure 3 below.

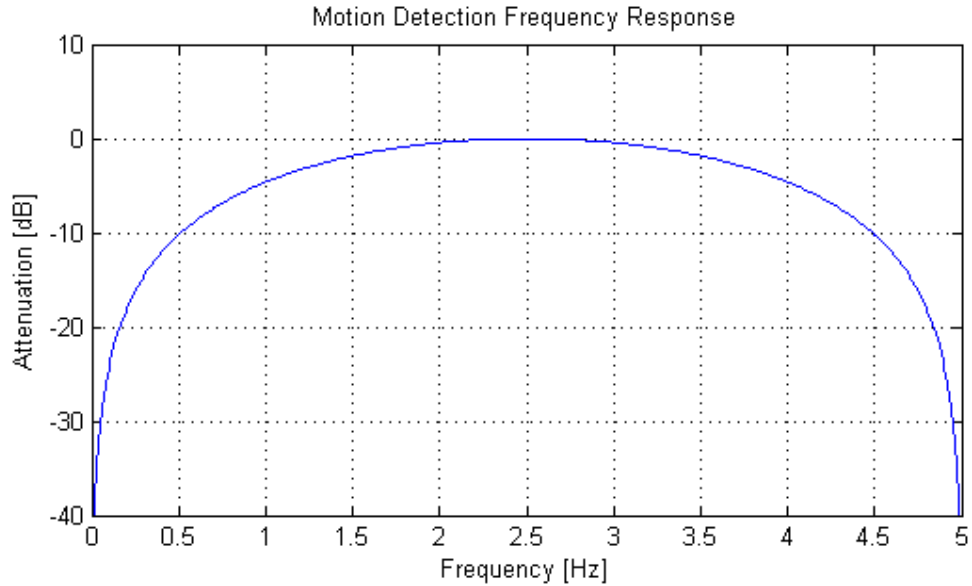

Figure 3. The MD band-pass filter's frequency response.

Threshold level can be controlled by MDTHR[6:0] bits and the time condition – how long the threshold should be exceeded to trigger – by MDTMR[3:0] bits.

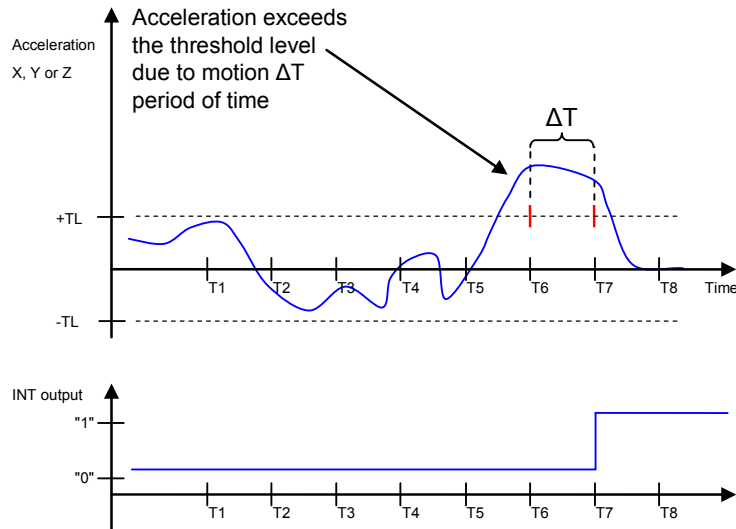

Figure 4. Motion detector operation

2.4.2 Usage

The MD mode can be enabled by setting the MODE[2:0] bits in the MODE register to "100". The trigger condition, threshold and duration, can be defined by setting MDTHR and MDFFTMR registers respectively. The device can be configured to switch automatically into 400Hz measurement mode by setting the MDET_EXIT bit in CTRL register. See section 3.3 register and section 2.6 for the interrupt functionality details.

In MD mode, band pass filtered acceleration data with 10Hz output data rate is available in registers DOUTX, DOUTY and DOUTZ.

2.4.3 Example

Below is a simple example of motion detection usage:

1. Write "00001000" (08h) into the MODE register (enable motion detection mode, MODE[2:0] bits = '100').
2. Band pass filtered acceleration data at 10 Hz sample rate is available at the output registers.
3. The INT-pin is activated when motion is detected; see section 2.6 for detailed INT-pin information.

2.5 Free-Fall Detection

2.5.1 Description

During free-fall in the gravitation field, all 3 orthogonal acceleration components are ideally equal to zero. Due to practical non-idealities, detection must be done using Threshold Level (TL) greater than 0.

When enabled, the Free-Fall Detection (FFD) will monitor the measured acceleration in the X, Y and Z directions. If all measured XYZ acceleration values stay within the TL longer than time TFF (Figure 5 below), the FFD will generate an interrupt to the INT-pin. TL can be controlled by FFTHR [6:0] and TFF by FFTMR [3:0] bits.

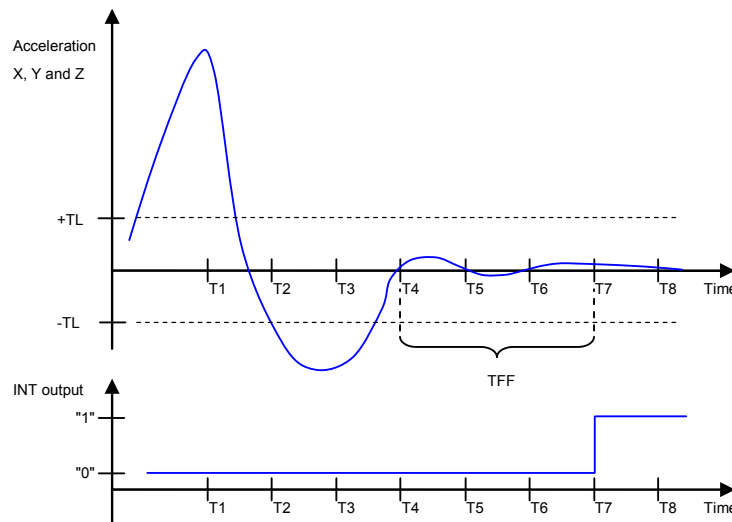

Figure 5. Free Fall condition

2.5.2 Usage

Free-fall detection can be enabled by setting MODE[2:0] bits in the CTRL register to "101" (sample rate 100 Hz) or to "110" (sample rate 400 Hz). See section 3.3 for MODE register details.

Acceleration data is available in registers DOUTX, DOUTY and DOUTZ as in measurement mode. See section 3.3 for output register and section 2.6 for interrupt functionality details.

2.5.3 Example

Below is a simple example of free-fall detection usage:

1. Write "00001100" (0Ch) into the MODE register (enable 400 Hz free fall detection mode, MODE[2:0] bits = '110').
2. Acceleration data can be read normally
3. INT-pin is activated when free fall is detected. See section 2.6 for detailed INT-pin information.

2.6 Interrupt function (INT-pin)

2.6.1 Usage

Depending on the CMA3000 operational configuration, the INT-pin can give an interrupt in following cases:

1. Normal measurement mode: INT-pin gives interrupt when new data is available
2. Free fall detection mode: INT-pin gives an interrupt to signal that free fall is detected
3. Motion detection mode: INT-pin gives an interrupt to signal that motion is detected

Interrupt polarity (active high/low) can be configured with CTRL register's INT_LEVEL bit.

If the CMA3000 is in normal measurement mode, the INT pin is automatically cleared by reading the acceleration output data. INT-pin data ready functionality can be disabled by setting the CTRL register's INT_DIS bit.

If INT-pin gives an interrupt in free fall or motion detection mode, the INT_STATUS register must be read to acknowledge and clear the interrupt.

In motion detection mode the INT_STATUS register content gives information of which XYZ directions have exceed the trigger conditions.

See section 3.3 for CTRL and INT_STATUS register details.

2.7 Clock

The CMA3000 has an internal factory trimmed oscillator and clock generator. Internal frequencies vary product by product.

3 Addressing Space

The CMA3000 register contents and bit definitions are described in more detail in the following sections.

3.1 Register Description

The CMA3000 addressing space is presented in Table 3 below.

Table 3. List of registers

Address	Name	Description	Mode (R, RW, NV)	Reg. type
00h	WHO_AM_I	Identification register	R	Output
01h	REVID	ASIC revision ID, fixed in metal	R	Output
02h	CTRL	Configuration (por, operation modes)	RW	Conf
03h	STATUS	Status (por, EEPROM parity)	R	Output
04h	RSTR	Reset Register	RW	Conf
05h	INT_STATUS	Interrupt status register	R	Output
06h	DOUTX	X channel output data register	R	Output
07h	DOUTY	Y channel output data register	R	Output
08h	DOUTZ	Z channel output data register	R	Output
09h	MDTHR	Motion detection threshold value register	RW	Conf
0Ah	MDFFTMR	Free fall and motion detection time register	RW	Conf
0Bh	FFTHR	Free fall threshold value register	RW	Conf
0Ch	I2C_ADDR	I ² C device address	R	Conf
0Dh-19h		Reserved		

Address is the register address in hex format.

RW – Read / Write register, R – Read-only register, NV – non-volatile register content.

3.2 Non-volatile memory

The CMA3000 has an internal non-volatile memory for calibration and configuration data. Memory content will be programmed during production and is not user configurable. Initial configuration values mirrored to volatile registers after reset can be found in the following section 3.3.

3.3 Registers

Address: **00h**

Register name: **WHO_AM_I**, Identification register

Bits	Mode	Initial Value	Name	Description
7	R	0		Reserved
6:0	R	xxh		Identification register

Address: **01h**

Register name: **REVID**, ASIC revision ID

Bits	Mode	Initial Value	Name	Description
7:4	R	1h	REVMAJ	Major revision number
3:0	R	0h	REVMIN	Minor revision number (metal mask change)

Address: **02h**

 Register name: **CTRL**, Control register

Bits	Mode	Initial Value	Name	Description
7	RW	0	G_RANGE	0 – 8g measurement range is selected 1 – 2g measurement range is selected
6	RW	0	INT_LEVEL	0 – INT is active when INT pin is set to logic high 1 – INT is active when INT pin is set to logic low
5	RW	0	MDET_EXIT	0 – Device goes to measurement mode after motion is detected (400Hz ODR) 1 – Device remains in motion detection mode after motion is detected.
4	RW	0	I2C_DIS	0 – I ² C interface enabled 1 – I ² C interface disabled.
3:1	RW	0	MODE[2:0]	000 – Power down mode, default mode. 001 – Measurement mode, 100 Hz ODR. 010 – Measurement mode, 400 Hz ODR. 011 – Measurement mode, 40 Hz ODR. 100 – Motion detection mode, 10 Hz ODR. 101 – Free fall detection mode, 100 Hz ODR. 110 – Free fall detection mode, 400 Hz ODR. 111 – Power down mode
0	RW	0	INT_DIS	0 – Interrupts enabled <ul style="list-style-type: none"> • Measurement mode: data ready • Motion detection mode: motion detected • Free fall detection mode: free fall detected 1 – Interrupts disabled

Note that after changing MODE bits it may take some time to recover the target operating state.
ODR = Output Data Rate.

 Address: **03h**

 Register name: **STATUS**, Status register

Bits	Mode	Initial Value	Name	Description
7:4		0h		Reserved
3	R	0	PORST	1 means Power-on-Reset state. Reading the register sets always bit to 0.
2:1		0h		Reserved
0	R	0	PERR	0 – No EEPROM Parity Error 1 – EEPROM Parity Error

 Address: **04h**

 Register name: **RSTR**, Reset register

Bits	Mode	Initial Value	Name	Description
7:0	RW	0h	RSTR	Writing 02h, 0Ah, 04h in this order resets ASIC. Other sequences reserved.

Address: **05h**

 Register name: **INT_STATUS**, Interrupt status register

Bits	Mode	Initial Value	Name	Description
7:3		0h		Reserved
2	R	0	FFDET	1 – Free fall detected (i.e. 0 g acceleration) 0 – Free fall not detected
1:0	R	0h	MDET	00 – No motion detected 01 – Trigger on X-axis 10 – Trigger on Y-axis 11 – Trigger on Z-axis

Note: Contents of INT_STATUS [2:0] is set to '000' always after reading of this register.

 Address: **06h**

 Register name: **DOUTX**, X-channel output register

Bits	Mode	Initial Value	Name	Description
7:0	R	0h	DOUTX	See SPI data frame description for more info.

 Address: **07h**

 Register name: **DOUTY**, Y-channel output register

Bits	Mode	Initial Value	Name	Description
7:0	R	0h	DOUTY	See SPI data frame description for more info.

 Address: **08h**

 Register name: **DOUTZ**, Z-channel output register

Bits	Mode	Initial Value	Name	Description
7:0	R	0h	DOUTZ	See SPI data frame description for more info.

The bit level description for acceleration data from DOUTX ... DOUTZ registers is presented in Table 4 below. The acceleration data is presented in 2's complement format. At 0 g acceleration the output is ideally 0h.

Table 4. Bit level description in [mg] for acceleration registers of CMA3000-D01.

Range	G_RANGE	Output sample rate	B7	B6	B5	B4	B3	B2	B1	B0
2g	1	400 Hz, 100 Hz	s	1142	571	286	143	71	36	1/56 = 18 mg
2g	1	40 Hz, 10 Hz	s	4571	2286	1142	571	286	143	1/14 = 71 mg
8g	0	400 Hz, 100 Hz	s	4571	2286	1142	571	286	143	1/14 = 71 mg
8g	0	40 Hz, 10 Hz	s	4571	2286	1142	571	286	143	1/14 = 71 mg

s = sign bit

Address: **09h**

 Register name: **MDTHR**, Motion detection threshold value register

Bits	Mode	Initial Value	Name	Description
7		0		Reserved
6:0	RW	8h	MDTHR[6:0]	Motion detection threshold level absolute value. See detailed bit level weighting in Table 5 (bits [6:0])

Table 5. Bit level description in [mg] for motion detection threshold of CMA3000-D01.

Range	G_RANGE	B7	B6	B5	B4	B3	B2	B1	B0
8g	0	x	4571	2286	1142	571	286	143	1/14 = 71 mg

x=not used bit

 Address: **0Ah**

 Register name: **MDFFTMR**, Motion and free fall detection time register

Bits	Mode	Initial Value	Name	Description
7:4	RW	3h	MDTMR[3:0]	Motion detection timer bits
3:0	RW	3h	FFTMR [3:0]	Free fall detection timer bits

The LSB bit weighting for MDTMR and FFTMR bits are converted to seconds by using the currently configured CMA3000 output data rate (ODR), as follows:

$$\text{MDTMR}_{\text{LSB}}[\text{sec}] = 1 / \text{ODR}[\text{Hz}], \text{ and}$$

$$\text{FFTMR}_{\text{LSB}}[\text{sec}] = 1 / \text{ODR}[\text{Hz}]$$

Were the ODR is the currently configured CMA3000 output data rate, which is defined by MODE bits (bits [3:1] in CTRL register). An example for CMA3000-D01 timer bit weighting is presented in Table 6 below.

Table 6. An example for CMA3000-D01 MDTMR and FFTMR bit level descriptions in [ms].

Timer	MDTMR				FFTMR			
	B7	B6	B5	B4	B3	B2	B1	B0
Register bit number	B7	B6	B5	B4	B3	B2	B1	B0
Timer bit number	MDTMR b3	MDTMR b2	MDTMR B1	MDTMR b0	FFTMR b3	FFTMR b2	FFTMR B1	FFTMR b0
CMA3000-D01, MODE bits x10 ODR: 400Hz	x	x	x	x	20	10	5	1/400s = 2,5 ms
CMA3000-D01, MODE bits x01 ODR: 100Hz	x	x	x	x	80	40	20	1/100s = 10 ms
CMA3000-D01, MODE bits 100 ODR: 10Hz	x	400	200	1/10s = 100 ms	x	x	x	x

x=not used bit

Address: **0Bh**

Register name: **FFTHR**, Free fall threshold value register

Bits	Mode	Initial Value	Name	Description
7:5		0h		Reserved, write these bits to '000'
4:0	RW	8h	FFTHR[5:0]	Free fall detection threshold level absolute value. See detailed bit level weighting in Table 7 below.

Table 7. Bit level description in [mg] for free fall detection threshold of CMA3000-D01.

Range	G_RANGE	B5	B4	B3	B2	B1	B0
2g	1	143	71	36	1/56=18 mg	x	x
8g	0	x	x	571	286	143	1/14 = 71 mg

x=not used bit

Address: **0Ch**

Register name: **I2C_ADDR**, Device address for I²C bus

Bits	Mode	Initial Value	Name	Description
7		0		Reserved
6:0	RW	1Ch	ADDR[6:0]	7-bit device address for I ² C bus. Register content is non-volatile.

4 Serial Interfaces

Communication between the CMA3000 sensor and master controller is based on serial data transfer and a dedicated interrupt line (INT-pin). Two different serial interfaces are available for the CMA3000 sensor: SPI and I²C (Phillips specification V2.1). Selection between these two interfaces is done using the chip select signal. The I²C interface can be also disabled by re-configuring register content. The CMA3000 acts as a slave on both the SPI and I²C bus.

4.1 SPI Interface

SPI bus is a full duplex synchronous 4-wire serial interface. It consists of one master device and one or more slave devices. The master is defined as a micro controller providing the SPI clock, and the slave as any integrated circuit receiving the SPI clock from the master. The CMA3000 sensor always operates as a slave device in master-slave operation mode. A typical SPI connection is presented in Figure 6.

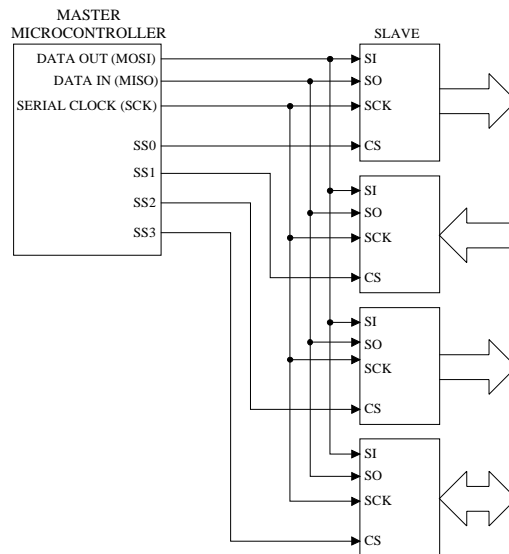

Figure 6. Typical SPI connection

The data transfer uses the following 4-wire interface:

MOSI	master out slave in	$\mu\text{C} \rightarrow \text{CMA3000}$
MISO	master in slave out	$\text{CMA3000} \rightarrow \mu\text{C}$
SCK	serial clock	$\mu\text{C} \rightarrow \text{CMA3000}$
CSB	chip select (low active)	$\mu\text{C} \rightarrow \text{CMA3000}$

4.1.1 SPI frame format

CMA3000 SPI frame format and transfer protocol is presented in Figure 7.

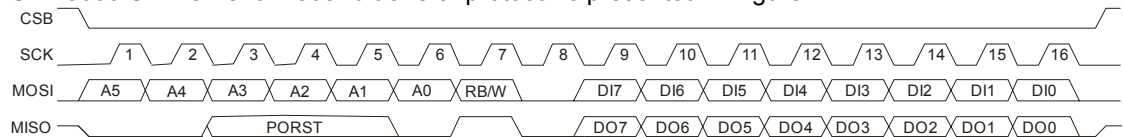

Figure 7. SPI frame format

Each communication frame contains 16 bits. The first 8 bits in MOSI line contains info about the register address being accessed and the operation (read/write). The first 6 bits define the 6 bit address for the selected operation, which is defined by bit 7 ('0' = read '1' = write), which is followed by one zero bit. The later 8 bits in the MOSI line contain data for a write operation and are

'don't-care' for a read operation. CMA3000 samples bits in from MOSI line on the rising edge of SCK and bits out to MISO line on falling edge of SCK.

After the two constant '0' bits in the MISO line are the PORST status bits. All three PORST status bits have the same value as the PORST bit in register STATUS. Bits 6 and 8 are always '0'. Bit 7 is always '1'. The later 8 bits contain data for a read operation.

For write commands, data is written into the addressed register after the rising edge of CSB.

For read commands, data is latched into the internal SPI output register (shift register) on the 8th rising edge of SCK. The output register is shifted out MSB first over MISO output.

When the CSB is high state between data transfers, the MISO line is in the high-impedance state.

4.1.2 Examples of SPI communication

4.1.2.1 Example of register read

An example of X-axis and Y-axis acceleration read command is presented in Figure 8. The master gives the register address to be read via the MOSI line: '06' in hex format and '000110' in binary format, register name is DOUTX). 7th bit is set to '0' to indicate the read operation.

The sensor replies to a requested operation by transferring the register content via MISO line. After transferring the asked DOUTX register content, the master gives next register address to be read: '07' in hex format and '000111' in binary format, register name is DOUTY. The sensor replies to the requested operation by transferring the register content MSB first.

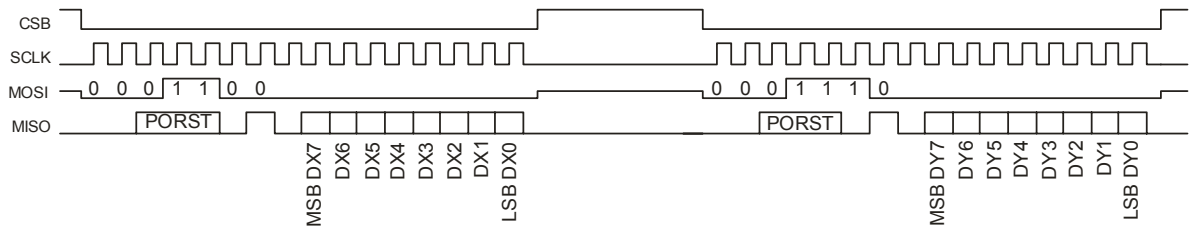

Figure 8. An example of SPI read communication.

4.1.3 Multiple slave devices in SPI bus

Since both SPI and I²C interfaces are enabled by default, certain precautions should be taken care of when the CMA3000 is connected to a SPI bus with multiple slave devices. In case of multiple devices on same SPI bus, it's important to prevent MOSI_SDA pin changes during SCK_SCL pin high state. If the MOSI_SDA pin state is changed when the SCK_SCL pin is in high state, the I²C transmission is engaged, see Figure 9 below.

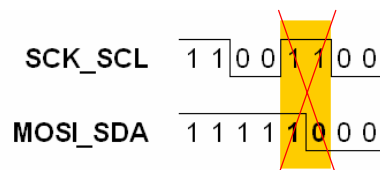

Figure 9. MOSI_SDA pin change during SCK_SCL high state engages I²C transmission.

In cases with multiple slaves in SPI bus it is recommended that I2C transmission is disabled by setting I2C_DIS bit to '1' in CTRL register. After CMA3000 start up the I2C_DIS bit is always 0 (I2C transmission enabled).

4.2 I²C Interface

I²C is a 2-wire serial interface. It consists of one master device and one or more slave devices. The master is defined as a micro controller providing the serial clock (SCL), and the slave as any integrated circuit receiving the SCL clock from the master. The CMA3000 sensor always operates as a slave device in master-slave operation mode. When using an SPI interface, a hardware addressing is used (slaves have dedicated CSB signals), the I²C interface uses a software based addressing (slave devices have dedicated bit patterns as addresses). The default I²C device address for CMA3000 is 00011100b (1Ch) (pre-programmed during CMA3000 production).

The CMA3000 is compatible to the Philips I²C specification V2.1. Main used features of the I²C interface are:

- 7-bit addressing, CMA3000 I²C device address is 1Ch
- Supports standard mode and fast mode
- Start / Restart / Stop
- Slave transceiver mode
- Designed for low power consumption

4.2.1 I²C frame format

4.2.1.1 I²C write mode

In I²C write mode, the first 8 bits after device address define the CMA3000 internal register address to be written.

4.2.1.2 I²C read mode

The read mode operates as described in Philips I²C specification. I²C read operation returns the content of the register which address is defined in I2C read frame. Read data is acknowledged by I²C master.

4.2.2 Examples of I²C communication

Examples of I²C communication are presented below in Figure 10. Address byte includes 7 device address bits (1Ch=0011100b) followed by the R/W bit.

CASE 1: I2C 8 bit read from register DOUTX

S	device addr byte 0011100	0	SA	register address byte 00000110	SA	RS	device addr byte 0011100	1	SA	register data MSB first	MA	E
---	-----------------------------	---	----	-----------------------------------	----	----	-----------------------------	---	----	-------------------------	----	---

CASE 2: I2C 8 bit write to register MDFFTIMR

S	device addr byte 0011100	0	SA	register address byte 00001010	SA	register data to write MSB first	SA	E
---	-----------------------------	---	----	-----------------------------------	----	-------------------------------------	----	---

S = Start condition
RS = Repeated Start Condition
E = End condition
SA = Slave acknowledgement
MA = Master acknowledgement

Figure 10 I²C format

5 Electrical Characteristics

All voltages are reference to ground. Currents flowing into the circuit have positive values.

5.1 Absolute maximum ratings

The absolute maximum ratings of the CMA3000 are presented in Table 8 below.

Table 8. Absolute maximum ratings of the CMA3000

Parameter	Value	Unit
Supply voltage (V_{dd} , DVIO)	-0.3 to +3.6	V
DVIO	$V_{dd}+0.2$	V
Voltage at input / output pins	-0.3 to ($V_{dd} + 0.3$)	V
ESD (Human body model)	± 2	kV
Storage temperature	-40 ... +125	$^{\circ}\text{C}$
Storage / operating temperature	-40 ... +85	$^{\circ}\text{C}$
Mechanical shock *	< 10 000	g
Exposure to ultrasonic energy (e.g. ultra sonic washing or welding)	Not allowed	

* 1 m drop on concrete may cause $\gg 10000$ g shock.

5.2 Power Supply

Please refer to the corresponding product datasheet.

5.3 Digital I/O Specification

5.3.1 Digital I/O DC characteristics

Table 9. DC characteristics of digital I/O pins.

No.	Parameter	Conditions	Symbol	Min	Typ	Max	Unit
Input: CSB, SCL with pull up SDA, SCK and MOSI without pull up / pull down							
2	Pull up current: CSB, SCL	$V_{IN} = 0V$	I_{PU}	-0.35			μA
2a.	Input Leakage	$V_{IN} = \text{DVIO}$	I_{IN}			0.035	μA
3	Input high voltage		V_{IH}	$0.54 \cdot D_{vio}$		$0.82 \cdot D_{vio}$	V
4	Input low voltage		V_{IL}	$0.18 \cdot D_{vo}$		$0.38 \cdot D_{vio}$	V
5	Hysteresis		V_{HYST}	$0.16 \cdot D_{vio}$		$0.63 \cdot D_{vio}$	V
Output terminal: MISO, SDA, INT							
7	Output high voltage	$I > -1 \text{ mA}$	V_{OH}	$0.7 \cdot D_{vio}$		D_{vio}	V
8	Output low voltage	$I < 1 \text{ mA}$	V_{OL}	0		$0.3 \cdot D_{vio}$	V
9	Tristate leakage	$0 < V_{MISO} < \text{DVIO}$	I_{LEAK}			0.0063	μA

5.3.2 Digital I/O level shifter

All the CMA3000 products have an internal level shifter that can be used to interface e.g. a micro controller using lower supply than the CMA3000. The level shifter is "programmed" by providing the supply voltage of the interfaced device to the DVIO-pin. Please refer to the corresponding product data sheet for details.

5.3.3 SPI AC characteristics

The AC characteristics of the CMA3000 SPI interface are defined in Figure 11 and in Table 10.

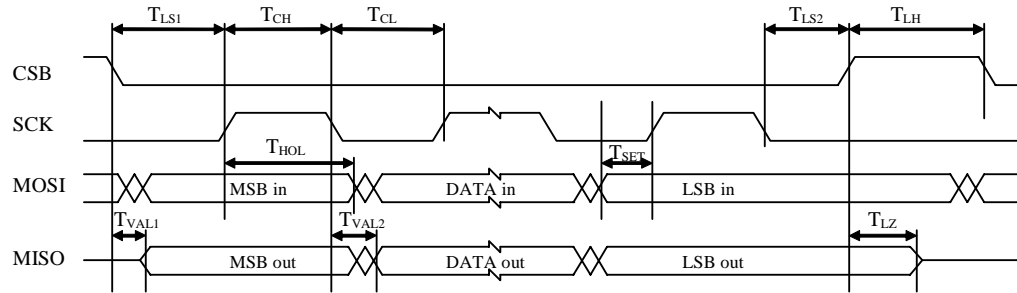

Figure 11. Timing diagram for SPI communication.

Table 10. AC characteristics of SPI communication.

No.	Parameter	Conditions	Symbol	Min	Typ	Max	Unit
Terminal CSB, SCK							
1	Time from CSB (10%) to SCK (90%) ⁽¹⁾		T_{LS1}	0.80*	$T_{per}/2$		ns
2	Time from SCK (10%) to CSB (90%) ⁽¹⁾		T_{LS2}	0.80*	$T_{per}/2$		ns
Terminal SCK							
3	SCK low time	Load capacitance at MISO < 50 pF	T_{CL}	0.80*	$T_{per}/2$		ns
4	SCK high time	Load capacitance at MISO < 50 pF	T_{CH}	0.80*	$T_{per}/2$		ns
5	SCK Frequency		$f_{sck} = 1/T_{per}$			0.5	MHz
Terminal MOSI, SCK							
6	Time from changing MOSI (10%, 90%) to SCK (90%) Data setup time		T_{SET}	$T_{per}/4$			ns
7	Time from SCK (90%) to changing MOSI (10%, 90%) Data hold time		T_{HOL}	$T_{per}/4$			ns
Terminal MISO, CSB							
8	Time from CSB (10%) to stable MISO (10%, 90%)	Load capacitance at MISO < 50 pF	T_{VAL1}			$T_{per}/4$	ns
9	Time from CSB (90%) to high impedance state of MISO ⁽¹⁾ .	Load capacitance at MISO < 50 pF	T_{LZ}			$T_{per}/4$	ns
Terminal MISO, SCK							
10	Time from SCK (10%) to stable MISO (10%, 90%) ⁽¹⁾ .	Load capacitance at MISO < 50 pF	T_{VAL2}			$1.5 * T_{per}/4$	ns
Terminal MOSI, CSB							
11	Time between SPI cycles, CSB at high level (90%)		T_{LH}	$11 * T_{per}$			ns

¹⁾ T_{per} is SCK period

5.3.4 I²C AC characteristics

Please, see Phillips Semiconductors, The I²C bus specification, Version 2.1, January 2000, pp. 31-33.

6 Package Characteristics

6.1 Dimensions

The package dimensions are presented in Figure 12 below (dimensions in millimeters [mm] with $\pm 50 \mu\text{m}$ tolerance).

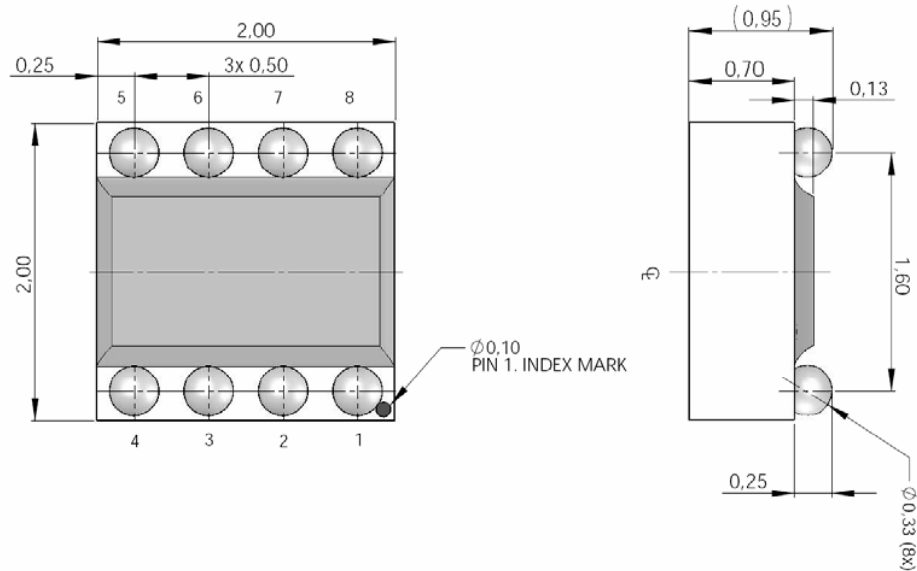

Figure 12. Package dimensions in mm with $\pm 50 \mu\text{m}$ tolerance for reference only. Please check the corresponding data sheet for details.

7 Application information

7.1 Pin Description

CMA3000 pin numbers are presented in Figure 14 below and pin descriptions in Table 11.

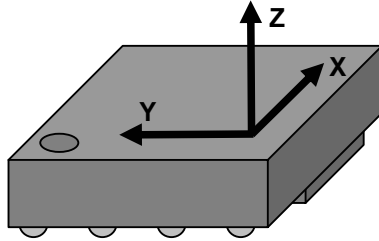

Figure 13. CMA3000 sensing directions

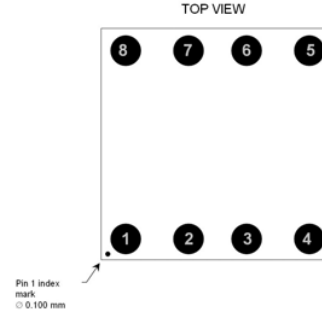

Figure 14. CMA3000 pin numbers

Table 11. CMA3000 pin descriptions

Pin #	Name	CMA3000-D01
1	VDD	Supply voltage
2	VSS	Ground
3	DVIO	I/O Supply
4	MISO	SPI Serial Data Output (MISO)
5	SCK_SCL	SPI Serial Clock (SCK) / I ² C Serial Clock (SCL)
6	MOSI_SDA	SPI Serial Data Input (MOSI) / I ² C Serial Data (SDA)
7	CSB	Chip select / I ² C enable
8	INT	Interrupt

7.2 Recommended circuit diagram

1. Connect 100 nF SMD capacitor between each supply voltage and ground level.
2. Use separate regulator for digital IO supply (DVIO).
3. Serial interface (SPI or I²C) logical '1' level is determined by DVIO supply voltage level.

Recommended circuit diagram for the CMA3000 with SPI interface is presented in Figure 15 below.

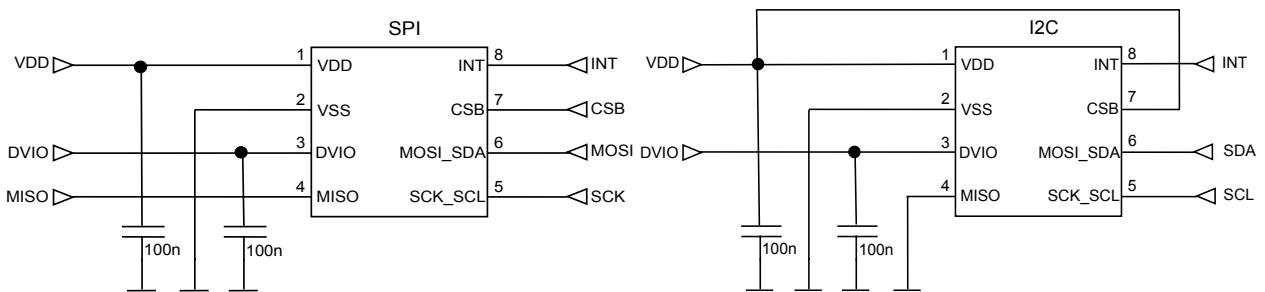

Figure 15 Recommended circuit diagrams for CMA3000-D0X

7.3 Recommended PWB layout

General PWB layout recommendations for CMA3000 products (refer to Figure 15 and Figure 16):

1. Locate 100 nF SMD capacitors right next to the CMA3000 package
2. Ensure low impedance by maximizing the ground plane under the component.

Recommended PWB pad layout for CMA3000 is presented in Figure 16 below (dimensions in micrometers, [μm]).

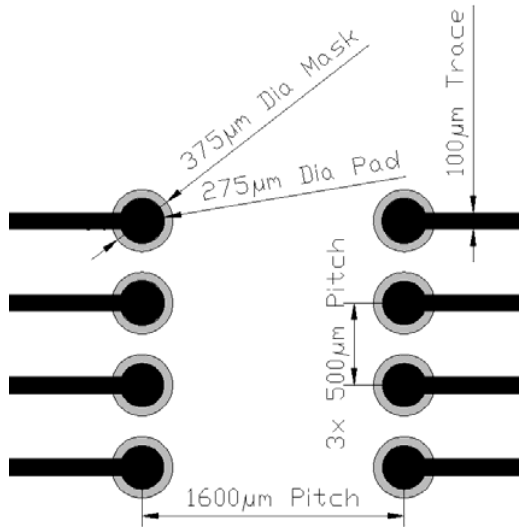

Figure 16. Recommended PWB pad layout for CMA3000.

Recommended PWB layout for the CMA3000-D0X is presented in Figure 17 below (circuit diagram presented in Figure 15 above).

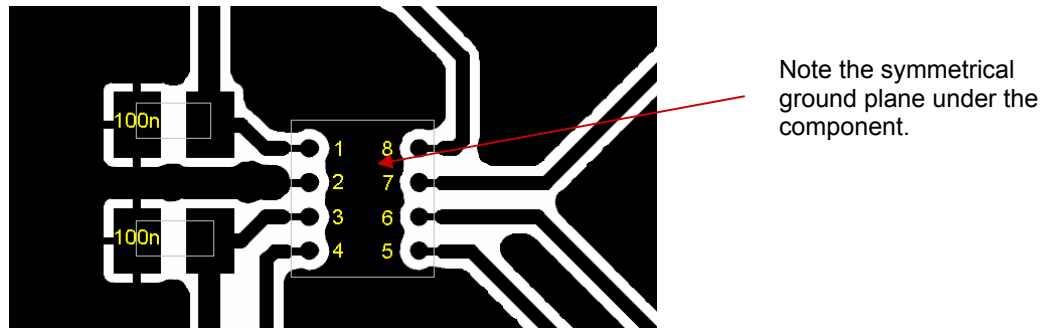

Figure 17. Recommended PWB layout for CMA3000-D0X with SPI interface (not actual size, for reference only).

7.4 Mounting recommendations

For the best sensor stability mechanical stresses due to mounting should be minimized. Potential causes of mechanical stress to be avoided are

- Contact with other structures due to too small mechanical tolerances.
- Placement under or next to mechanical push button contacts.
- Locations near hot spots (micro controller, power amplifier etc) due to temperature effects.
- Mounting close to PWB attachment point e.g. screw or snap.

- PWB areas that can bend or vibrate.
- The use of under fill or coating. Please note that under fill or coating the neighboring component should not be in contact with the sensor.

Due to sampled signal conditioning strong magnetic or electric fields may cause noise in the sensor output. Therefore mounting near strong magnetic or electric fields is not recommended.

7.5 Assembly instructions

The Moisture Sensitivity Level (MSL) of the CMA3000 component is 2 according to the IPC/JEDEC J-STD-020D. Please refer to the document TN68_CMA3000_Assembly_Instructions for more detailed information about CMA3000 assembly.

7.6 Tape and reel specifications

Please refer to the document TN68_CMA3000_Assembly_Instructions for tape and reel specifications.

8 Data sheet references

8.1 Offset

CMA3000's offset will be calibrated in X = 0 g, Y = 0 g, and Z = +1 g (Z measuring axis is parallel to earth's gravitation) position, see Figure 18.

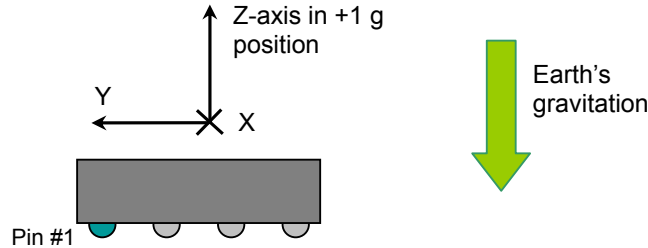

Figure 18. CMA3000 offset (0 g) position.

8.1.1 Offset calibration error

Offset calibration error is the difference between the sensor's actual output reading and the nominal output reading in calibration conditions. Error is calculated by

Equation 1

$$Offset_{X-axisCalibEr} = \frac{Output_{X-axis} - Output}{Sens} \cdot 1000,$$

where $Output_{X-axisCalibEr}$ is sensor's X-axis calibration error in [mg], $Output_{X-axis}$ is sensor's X-axis output reading [counts], $Output$ is sensor's nominal output in 0 g position and $Sens$ sensor's nominal sensitivity [counts/g].

8.1.2 Offset temperature error

Offset temperature error is the difference between the sensor's output reading in different temperatures and the sensor's calibrated offset value at room temperature. Error is calculated by

Equation 2

$$Offset_{X-axisTempEr@T} = \frac{Output_{X-axis@T} - Output_{X-axis@RT}}{Sens} \cdot 1000,$$

where $Output_{X-axisTempEr@T}$ is sensor's X-axis temperature error in [mg] in temperature T , $Output_{X-axis@T}$ is sensor's X-axis output reading [counts] in temperature T , $Output_{X-axis@RT}$ X-axis output reading [counts] at room temperature RT and $Sens$ sensor's nominal sensitivity [counts/g]. Sensor is in 0 g position for every measurement point.

8.2 Sensitivity

During sensitivity calibration, the sensor is placed in ± 1 g positions having one of the sensor's measuring axes at a time parallel to the earth's gravitation, see Figure 19.

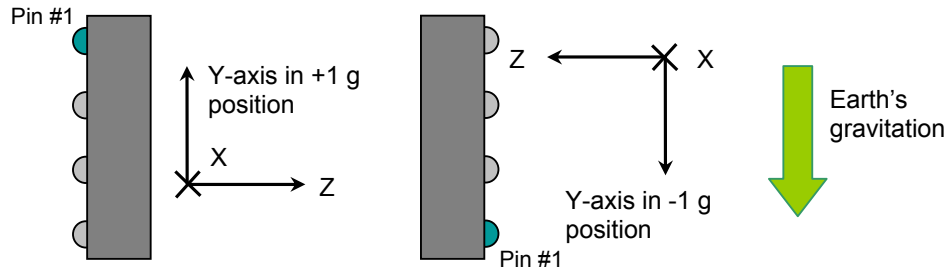

Figure 19. CMA3000 positions for Y-axis sensitivity measurement.

Sensitivity is calculated by

Equation 3

$$Sens_{Y-axis} = \frac{Output_{Y-axis@+1g} - Output_{Y-axis@-1g}}{2g},$$

where $Sens_{Y-axis}$ is sensor's Y-axis sensitivity in [counts/g], $Output_{Y-axis@+1g}$ sensor's Y-axis output reading [counts] in +1 g position and $Output_{Y-axis@-1g}$ is sensor's Y-axis output reading [counts] in -1 g position.

8.2.1 Sensitivity calibration error

Sensitivity calibration error is the difference between sensor's measured sensitivity and the nominal sensitivity at room temperature conditions. Error is calculated by

Equation 4

$$Sens_{Y-axisCalibEr} = \frac{Sens_{Y-axis} - Sens}{Sens} \cdot 100\%,$$

where $Sens_{Y-axisCalibEr}$ is sensor's Y-axis sensitivity calibration error in [%], $Sens_{Y-axis}$ sensor's Y-axis sensitivity [counts/g] at room temperature conditions and $Sens$ is sensor's nominal sensitivity [counts/g].

8.2.2 Sensitivity temperature error

Sensitivity temperature error is the difference between sensor's sensitivity at different temperatures and the calibrated sensitivity. Error is calculated by

Equation 5

$$Sens_{Y-axisTempEr@T} = \frac{Sens_{Y-axis@T} - Sens_{Y-axis@RT}}{Sens_{Y-axis@RT}} \cdot 100\%,$$

where $Sens_{Y-axisTempEr@T}$ is sensor's Y-axis sensitivity temperature error in [%] in temperature T , $Sens_{Y-axis@T}$ is sensor's measured Y-axis sensitivity [counts/g] at temperature T and $Sens_{Y-axis@RT}$ is sensor's measured Y-axis sensitivity [counts/g] at room temperature RT .

8.3 Linearity

The needed accurate input acceleration in linearity characterization is generated using centrifugal force in centrifuge, see Figure 20. The RPM of the centrifuge is swept so that wanted input acceleration values are applied in parallel to the sensor's measuring axis.

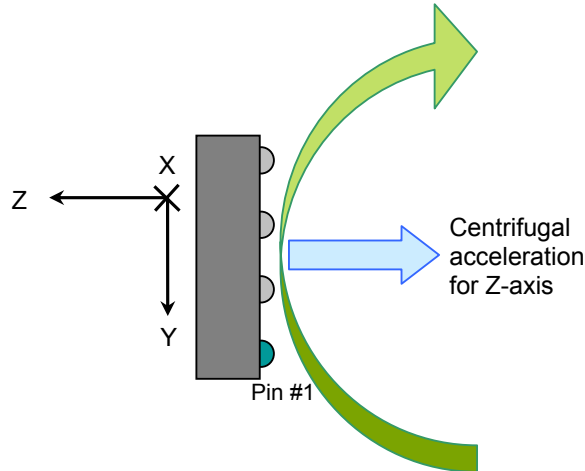

Figure 20. Centrifugal acceleration applied for CMA3000 Z-axis.

Linearity error is the deviation from the best bit straight line. See Figure 21.

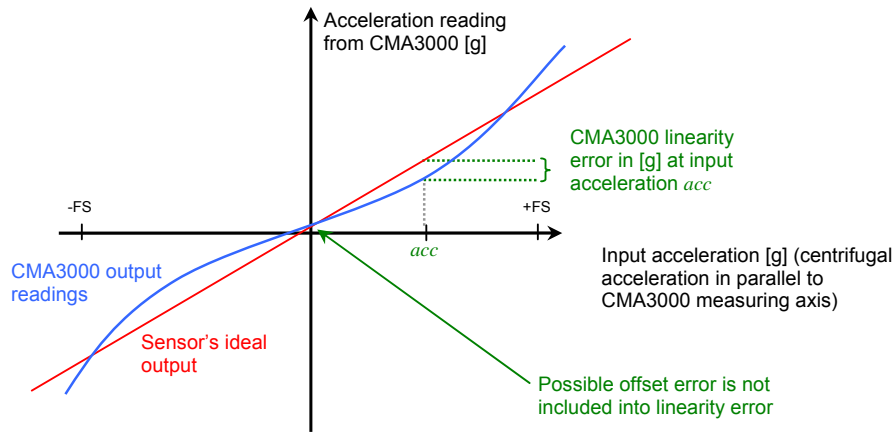

Figure 21. CMA3000's linearity error at input acceleration acc .

Linearity error is calculated by

Equation 6

$$LinEr_{Z-axis@acc} = \frac{Output_{Z-axis@acc} - Output_{@acc}}{Sens \cdot FS} \cdot 100\% ,$$

where $LinEr_{Z-axis@acc}$ is sensor's Z-axis linearity error [%FS] on input acceleration acc , $Output_{Z-axis@acc}$ is sensor's measured Z-axis output [counts] on input acceleration acc , $Output_{@acc}$ is sensor's nominal output [counts] on input acceleration acc , $Sens$ is sensor's nominal sensitivity [counts/g] and FS is sensor's full scale measuring range [g] (for example for CMA3000-D01 with $\pm 2g$ setting $\rightarrow FS = 2g$).

Sensor's ideal output $Output_{@acc}$ (in Equation 6) is calculated by fitting a straight line to measured accelerations from $-FS$ to FS .

8.4 Noise

Output noise n_x , n_y and n_z in X,Y and Z directions is the measured standard deviation of the output values when the sensor is in 0 g position at room temperature. Average noise/axis is calculated by

Equation 7

$$n = \sqrt{\frac{1}{3}(n_x^2 + n_y^2 + n_z^2)},$$

where n is sensor's noise [g] per axis, n_x is sensor's X-axis noise [g], n_y is sensor's Y-axis noise [g] and n_z is sensor's Z-axis noise [g].

CMA3000 demo-kit design can be used as a reference design for noise measurements, refer to "CMA3000 DEMO KIT User Manual 8288400".

8.5 Bandwidth

Signal bandwidth is measured in a shaker by sweeping the piston movement frequency with constant amplitude (Figure 22).

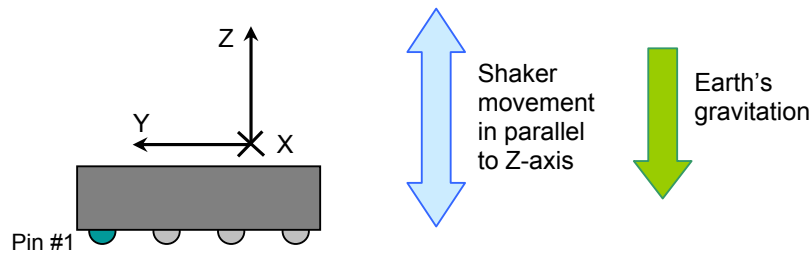

Figure 22. CMA3000 movement in Z-axis bandwidth measurement.

8.6 Cross-axis sensitivity

Cross-axis sensitivity is sum of the alignment and the inherent sensitivity errors. Cross-axis sensitivity of one axis is a geometric sum of the sensitivities in two perpendicular directions.

Cross-axis sensitivity [%] of X-axis is given by

Equation 8

$$Cross_X = \pm \frac{\sqrt{S_{XY}^2 + S_{XZ}^2}}{S_X} \cdot 100\%,$$

where S_{XY} is X-axis sensitivity to Y-axis acceleration [Count/g], S_{XZ} is X-axis sensitivity to Z-axis acceleration [Count/g] and S_X is sensitivity of X-axis [Count/g].

Cross-axis sensitivity [%] of Y-axis is given by

Equation 9

$$Cross_Y = \pm \frac{\sqrt{S_{YX}^2 + S_{YZ}^2}}{S_Y} \cdot 100\%,$$

where S_{YX} is Y-axis sensitivity to X-axis acceleration [Count/g], S_{YZ} is Y-axis sensitivity to Z-axis acceleration [Count/g] and S_Y is sensitivity of Y-axis [Count/g].

Cross-axis sensitivity [%] of Z-axis is given by

Equation 10

$$Cross_Z = \pm \frac{\sqrt{S_{ZX}^2 + S_{ZY}^2}}{S_Z} \cdot 100\%,$$

where S_{ZX} is Z-axis sensitivity to X-axis acceleration [Count/g], S_{ZY} is Z-axis sensitivity to Y-axis acceleration [Count/g] and S_Z is sensitivity of Z-axis [Count/g].

Cross-axis sensitivity of CMA3000 family is measured in centrifuge over specified measurement range during qualification. Correct mounting position of component is important during the measurement of cross-axis sensitivity.

8.7 Turn-on time

Turn-on time is the time when the last of one X, Y, Z axis output readings stabilizes into its final value after XRESET is pulled high. The final value limits in turn-on time measurements is defined to be $\pm 1\%$ of the sensor's full scale measuring range (for example for CMA3000-D01 $\pm 2g \rightarrow FS = 2\text{ g}$). Turn-on time definition for Z-axis is presented in Figure 23 below.

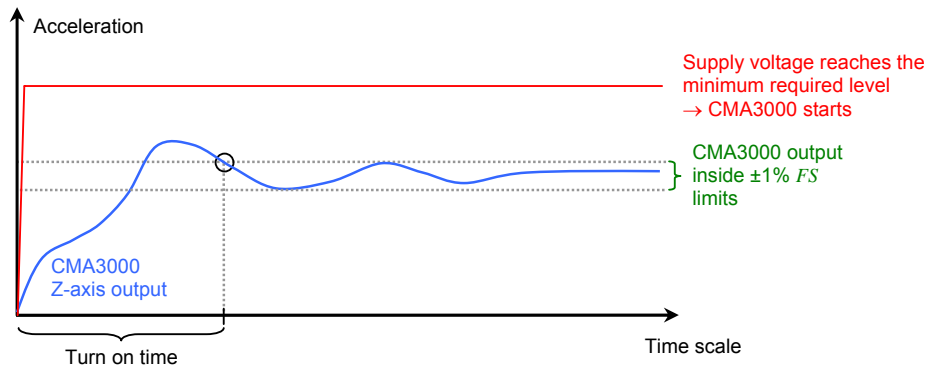

Figure 23. Turn-on time definition for one axis.

9 Known issues

9.1 Acceleration data reading via I²C bus

CMA3000-D01 has a design issue (to be corrected) related to acceleration data reading via I²C bus: acceleration data reading during the INT-pin assertion (i.e. internal output register update) causes the data corruption. The following sections discuss how to overcome this.

9.1.1 Interrupt based acceleration reading

Interrupt (INT-pin) based acceleration data reading can be used only in measurement mode. After interrupt signal activation the acceleration data has to be read before next interrupt activation. The allowed reading time depends on selected measurement mode. Detailed timing values are presented in Table 12 and Figure 24 below.

Table 12. CMA3000-D01 maximum reading periods in interrupt based acceleration data reading.

Output data rate	Maximum reading period, T_r
CMA3000-D01, MODE bits x10 ODR: 400Hz	2.25 ms
CMA3000-D01, MODE bits x01 ODR: 100Hz	9.0 ms
CMA3000-D01, MODE bits 011 ODR: 40Hz	22.5 ms

ODR = Output Data Rate

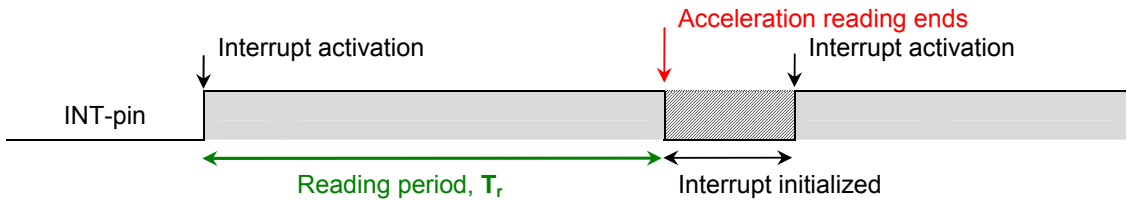

Figure 24. Interrupt based CMA3000 acceleration data read timing.

If the above presented data read timing constraints are not met, the acceleration output data should be ignored. Valid data samples can be read after the next interrupt signal.

9.1.2 Acceleration reading without interrupts

Acceleration data reading without interrupts can be used in all operation modes. Acceleration data is read out faster than CMA3000 can update the acceleration output registers. When two identical XYZ acceleration values are received, the data is considered valid. The maximum data reading periods in different operation modes are presented below in Table 13.

Table 13. CMA3000-D01 maximum reading periods when interrupts are not detected.

Output data rate	Maximum reading period for 3 samples, T_r
CMA3000-D01, MODE bits x10 ODR: 400Hz	2.4 ms
CMA3000-D01, MODE bits x01 ODR: 100Hz	9.9 ms
CMA3000-D01, MODE bits 011 ODR: 40Hz	24.0 ms
CMA3000-D01, MODE bits 100 ODR: 10Hz	90.0 ms

ODR = Output Data Rate

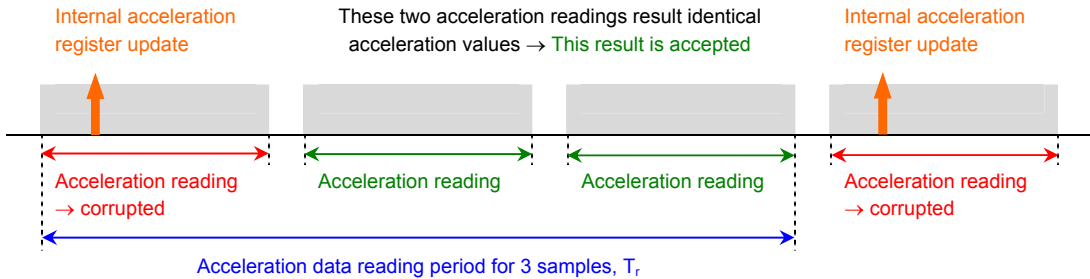

Figure 25. Interrupt based CMA3000 acceleration data read timing.

9.2 Leakage current when $VDD - DVIO > 0.3 V$

Due to design issue a switch will leak some current, if the VDD will be approx 300 mV higher than DVIO. Typical leakage currents are according to the Table 14 below.

Table 14 CMA3000-D0X typical DVIO leakage current when $VDD-DVIO>0.3V$.

VDD/DVIO [V]	Leakage current [μA]
2.5 / 1.7	25
3.6 / 1.7	100

10 Order Information

Order code	Description	Packing	Quantity
CMA3000-D01-1	3-Axis accelerometer with SPI&I2C interface, +/- 2/8g, 100 pcs	T&R	100
CMA3000-D01-10	3-Axis accelerometer with SPI&I2C interface, +/- 2/8g, 1000 pcs	T&R	1000
CMA3000-D01-30	3-Axis accelerometer with SPI&I2C interface, +/- 2/8g, 3000 pcs	T&R	3000
CMA3000-D01 PWB	PWB assy 3-Axis accelerometer with SPI&I2C interface, +/- 2/8g	Bulk	1
CMA3000-D01DEMO	CMA3000-D01 DEMOKIT	Bulk	1

11 Document Change Control

Version	Date	Change Description
0.1	06-Sep-07	Initial draft.
0.2	11-Jan-08	Major update.
0.3	14-Feb-08	Minor updates, corrections
0.4	18-Apr-08	Minor updates, section 'Known issues' added
0.5	01-Jul-08	Figure 1,&12 updated, table 9 updated
0.6	29-Aug-08	Sensitivities from 1/60 and 1/15 counts/g updated to 1/56 and 1/14 counts/g
0.7	10-Dec-08	Figure 12 updated. Tables 4, 5, 7, 9, 10 updated. Sections 9.2 and 9.3 added.
0.8	29-Dec-08	Launch version. Table 6 updated.
0.9	28-Jan-09	Table 5, 7 & 10 updated.
0.10	02-Mar-09	Typo corrections, 3.3 register initial values updated, 4.2 I ² C address updated, 8.4 demo kit document number updated, preliminary tag removed, MSL level 3 -> 2, 7.2 removed reference to 1uF capacitor
0.11	08-Jun-09	Figure 4 updated, 4.2.2 I ² C address byte description updated Mounting recommendations (section 7.4) added.
0.12	12-Jun-09	Device bandwidth updated to ODR/5

12 Contact Information

Finland

(head office)

VTI Technologies Oy
P.O. Box 27
Myllynkivenkuja 6
FI-01621 Vantaa
Finland
Tel. +358 9 879 181
Fax +358 9 8791 8791
E-mail: sales@vti.fi

Japan

VTI Technologies Oy
Tokyo Office
Tokyo-to, Minato-ku 2-7-16
Bureau Toranomom 401
105-0001
Japan
Tel. +81 3 6277 6618
Fax +81 3 6277 6619
E-mail: sales.japan@vti.fi

Germany

VTI Technologies Oy
Branch Office Frankfurt
Rennbahnstrasse 72-74
D-60528 Frankfurt am Main,
Germany
Tel. +49 69 6786 880
Fax +49 69 6786 8829
E-mail: sales.de@vti.fi

China

VTI Technologies Shanghai Office
6th floor, Room 618
780 Cailun Lu
Pudong New Area
201203 Shanghai
P.R. China
Tel. +86 21 5132 0417
Fax +86 21 513 20 416
E-mail: sales.china@vti.fi

USA

VTI Technologies, Inc.
One Park Lane Blvd.
Suite 804 - East Tower
Dearborn, MI 48126
USA
Tel. +1 313 425 0850
Fax +1 313 425 0860
E-mail: sales@vtitechnologies.com

To find out your local sales
representative visit www.vti.fi