



TC1017

150 mA, Tiny CMOS LDO With Shutdown

Features

- Space-saving 5-Pin SC-70 and SOT-23 Packages
- Extremely Low Operating Current for Longer Battery Life: 53 μ A (typ.)
- Very Low Dropout Voltage
- Rated 150 mA Output Current
- Requires Only 1 μ F Ceramic Output Capacitance
- High Output Voltage Accuracy: $\pm 0.5\%$ (typ.)
- 10 μ sec (typ.) Wake-Up Time from $\overline{\text{SHDN}}$
- Power-Saving Shutdown Mode: 0.05 μ A (typ.)
- Overcurrent and Overtemperature Protection
- Pin Compatible Upgrade for Bipolar Regulators

Applications

- Cellular/GSM/PHS Phones
- Battery Operated Systems
- Portable Computers
- Medical Instruments
- Electronic Games
- Pagers

General Description

The TC1017 is a high-accuracy (typically $\pm 0.5\%$) CMOS upgrade for bipolar low dropout regulators. It is offered in a SC-70 or SOT-23 package. The SC-70 package represents a 50% reduced footprint versus the popular SOT-23 package.

Developed specifically for battery-powered systems, the TC1017's CMOS construction consumes only 53 μ A typical supply current over the entire 150 mA operating load range. This can be as much as 60 times less than the quiescent operating current consumed by bipolar LDOs.

With small-space requirements and cost in mind, the TC1017 was developed to be stable over the entire input voltage and output current operating range using low value (1 μ F ceramic), low equivalent series resistance output capacitors. Additional integrated features, such as shutdown, overcurrent and overtemperature protection, further reduce the board space and cost of the entire voltage regulating application.

Key performance parameters for the TC1017 are low dropout voltage (285 mV typical at 150 mA output current), low supply current while shutdown (0.05 μ A typical) and fast stable response to sudden input voltage and load changes.

Package Types

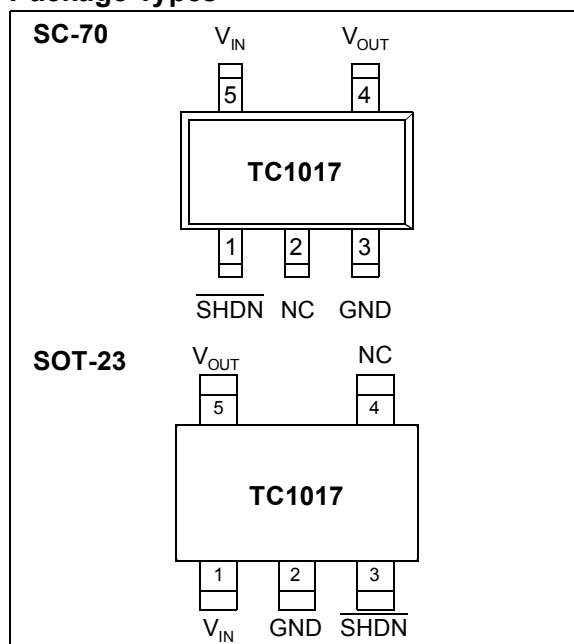

1.0 ELECTRICAL CHARACTERISTICS

Absolute Maximum Ratings †

Input Voltage 6.5V
 Output Voltage (–0.3) to (V_{IN} + 0.3)
 Power Dissipation Internally Limited (Note 7)
 Maximum Voltage On Any Pin V_{IN} + 0.3V to –0.3V

† **Notice:** Stresses above those listed under "Maximum Ratings" may cause permanent damage to the device. This is a stress rating only and functional operation of the device at those or any other conditions above those indicated in the operation listings of this specification is not implied. Exposure to maximum rating conditions for extended periods may affect device reliability.

PIN FUNCTION TABLE

Name	Function
$\overline{\text{SHDN}}$	Shutdown control input.
NC	No connect
GND	Ground terminal
V _{OUT}	Regulated voltage output
V _{IN}	Unregulated supply input

ELECTRICAL CHARACTERISTICS

Electrical Specifications: Unless otherwise noted, V _{IN} = V _R + 1V, I _L = 100 μA, C _L = 1.0 μF, $\overline{\text{SHDN}} > V_{IH}$, T _A = +25°C Boldface type specifications apply for junction temperatures of –40°C to +125°C.						
Parameter	Sym	Min	Typ	Max	Units	Test Conditions
Input Operating Voltage	V _{IN}	2.7	—	6.0	V	Note 1
Maximum Output Current	I _{OUTMAX}	150	—	—	mA	
Output Voltage	V _{OUT}	V_R – 2.5%	V _R ±0.5%	V_R + 2.5%	V	Note 2
V _{OUT} Temperature Coefficient	TCV _{OUT}	—	40	—	ppm/°C	Note 3
Line Regulation	$[(\Delta V_{OUT}/\Delta V_{IN})] / V_R$	—	0.04	0.2	%/V	(V _R + 1V) < V _{IN} < 6V
Load Regulation (Note 4)	$ \Delta V_{OUT} / V_R$	—	0.38	1.5	%	I _L = 0.1 mA to I _{OUTMAX}
Dropout Voltage (Note 5)	V _{IN} – V _{OUT}	—	2	—	mV	I _L = 100 μA I _L = 50 mA I _L = 100 mA I _L = 150 mA
Supply Current	I _{IN}	—	53	90	μA	$\overline{\text{SHDN}} = V_{IH}$, I _L = 0
Shutdown Supply Current	I _{INSD}	—	0.05	2	μA	$\overline{\text{SHDN}} = 0V$
Power Supply Rejection Ratio	PSRR	—	58	—	dB	f = 1 kHz, I _L = 50 mA
Wake-Up Time (from Shutdown Mode)	t _{WK}	—	10	—	μs	V _{IN} = 5V, I _L = 60 mA, C _{IN} = C _{OUT} = 1 μF, f = 100 Hz

Note 1: The minimum V_{IN} has to meet two conditions: V_{IN} ≥ 2.7V and V_{IN} ≥ (V_R + 2.5%) + V_{DROPOUT}.

2: V_R is the regulator voltage setting. For example: V_R = 1.8V, 2.7V, 2.8V, 3.0V.

3:

$$TCV_{OUT} = \frac{(V_{OUTMAX} - V_{OUTMIN}) \times 10^6}{V_{OUT} \times \Delta T}$$

4: Regulation is measured at a constant junction temperature using low duty-cycle pulse testing. Load regulation is tested over a load range from 0.1 mA to the maximum specified output current. Changes in output voltage due to heating effects are covered by the thermal regulation specification.

5: Dropout voltage is defined as the input-to-output differential at which the output voltage drops 2% below its nominal value at a 1V differential.

6: Thermal regulation is defined as the change in output voltage at a time T after a change in power dissipation is applied, excluding load or line regulation effects. Specifications are for a current pulse equal to I_{LMAX} at V_{IN} = 6V for t = 10 msec.

7: The maximum allowable power dissipation is a function of ambient temperature, the maximum allowable junction temperature and the thermal resistance from junction-to-air (i.e. T_A, T_J, θ_{JA}). Exceeding the maximum allowable power dissipation causes the device to initiate thermal shutdown. Please see **Section 5.1, "Thermal Considerations"**, for more details.

ELECTRICAL CHARACTERISTICS (CONTINUED)

Electrical Specifications: Unless otherwise noted, $V_{IN} = V_R + 1V$, $I_L = 100 \mu A$, $C_L = 1.0 \mu F$, $\overline{SHDN} > V_{IH}$, $T_A = +25^\circ C$ Boldface type specifications apply for junction temperatures of $-40^\circ C$ to $+125^\circ C$.						
Parameter	Sym	Min	Typ	Max	Units	Test Conditions
Settling Time (from Shutdown Mode)	t_s	—	32	—	μs	$V_{IN} = 5V$, $I_L = 60 mA$, $C_{IN} = 1 \mu F$, $C_{OUT} =$ $1 \mu F$, $f = 100 Hz$
Output Short-Circuit Current	I_{OUTSC}	—	120	—	mA	$V_{OUT} = 0V$, Average Current
Thermal Regulation	V_{OUT}/P_D	—	0.04	—	V/W	Notes 6, 7
Thermal Shutdown Die Temperature	T_{SD}	—	160	—	$^\circ C$	
Thermal Shutdown Hysteresis	ΔT_{SD}	—	10	—	$^\circ C$	
Output Noise	eN	—	800	—	nV/ \sqrt{Hz}	$f = 10 kHz$
\overline{SHDN} Input High Threshold	V_{IH}	45	—	—	% V_{IN}	$V_{IN} = 2.7V$ to $6.0V$
\overline{SHDN} Input Low Threshold	V_{IL}	—	—	15	% V_{IN}	$V_{IN} = 2.7V$ to $6.0V$

Note 1: The minimum V_{IN} has to meet two conditions: $V_{IN} \geq 2.7V$ and $V_{IN} \geq (V_R + 2.5\%) + V_{DROPOUT}$.

2: V_R is the regulator voltage setting. For example: $V_R = 1.8V, 2.7V, 2.8V, 3.0V$.

3:

$$TCV_{OUT} = \frac{(V_{OUTMAX} - V_{OUTMIN}) \times 10^6}{V_{OUT} \times \Delta T}$$

4: Regulation is measured at a constant junction temperature using low duty-cycle pulse testing. Load regulation is tested over a load range from 0.1 mA to the maximum specified output current. Changes in output voltage due to heating effects are covered by the thermal regulation specification.

5: Dropout voltage is defined as the input-to-output differential at which the output voltage drops 2% below its nominal value at a 1V differential.

6: Thermal regulation is defined as the change in output voltage at a time T after a change in power dissipation is applied, excluding load or line regulation effects. Specifications are for a current pulse equal to I_{LMAX} at $V_{IN} = 6V$ for $t = 10$ msec.

7: The maximum allowable power dissipation is a function of ambient temperature, the maximum allowable junction temperature and the thermal resistance from junction-to-air (i.e. T_A, T_J, θ_{JA}). Exceeding the maximum allowable power dissipation causes the device to initiate thermal shutdown. Please see **Section 5.1, "Thermal Considerations"**, for more details.

TEMPERATURE CHARACTERISTICS

Electrical Specifications: Unless otherwise indicated, $V_{DD} = +2.7V$ to $+5.5V$ and $V_{SS} = GND$.						
Parameters	Sym	Min	Typ	Max	Units	Conditions
Temperature Ranges						
Specified Temperature Range	T_A	-40	—	+85	$^\circ C$	Industrial Temperature parts
	T_A	-40	—	+125	$^\circ C$	Extended Temperature parts
Operating Temperature Range	T_A	-40	—	+125	$^\circ C$	
Storage Temperature Range	T_A	-65	—	+150	$^\circ C$	
Thermal Package Resistances						
Thermal Resistance, 5L-SOT23	θ_{JA}	—	255	—	$^\circ C/W$	
Thermal Resistance, 5L-SC-70	θ_{JA}	—	450	—	$^\circ C/W$	

2.0 TYPICAL PERFORMANCE CHARACTERISTICS

Note: The graphs and tables provided following this note are a statistical summary based on a limited number of samples and are provided for informational purposes only. The performance characteristics listed herein are not tested or guaranteed. In some graphs or tables, the data presented may be outside the specified operating range (e.g., outside specified power supply range) and therefore outside the warranted range.

Note: Unless otherwise noted, $V_{IN} = V_R + 1V$, $I_L = 100 \mu A$, $C_L = 1.0 \mu F$, $SHDN > V_{IH}$, $T_A = +25^\circ C$.

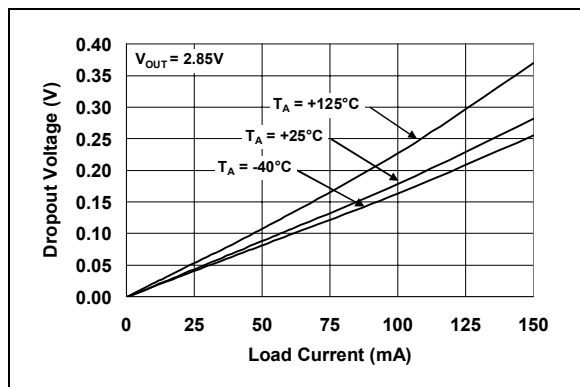

FIGURE 2-1: Dropout Voltage vs. Output Current.

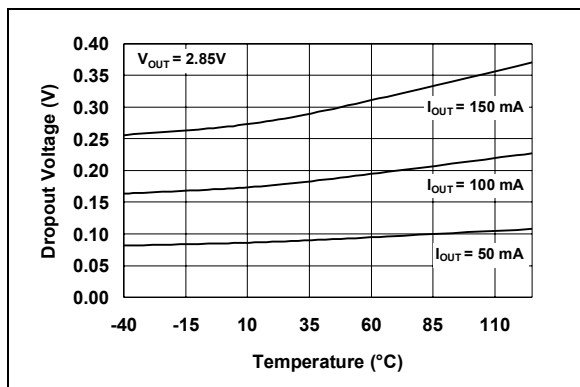

FIGURE 2-4: Dropout Voltage vs. Temperature.

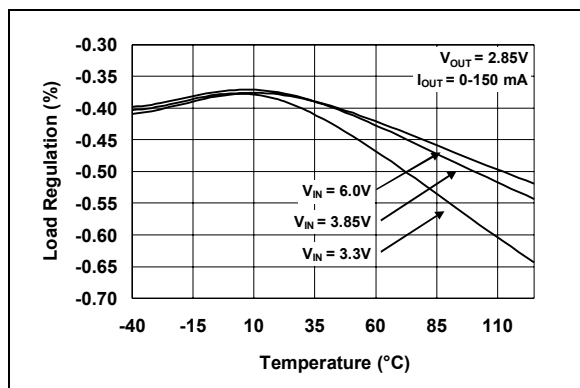

FIGURE 2-2: Load Regulation vs. Temperature.

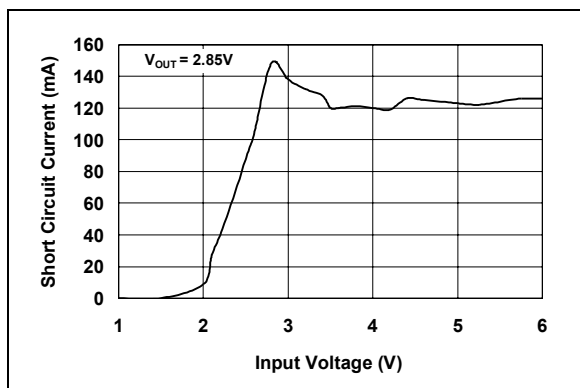

FIGURE 2-5: Short-Circuit Current vs. Input Voltage.

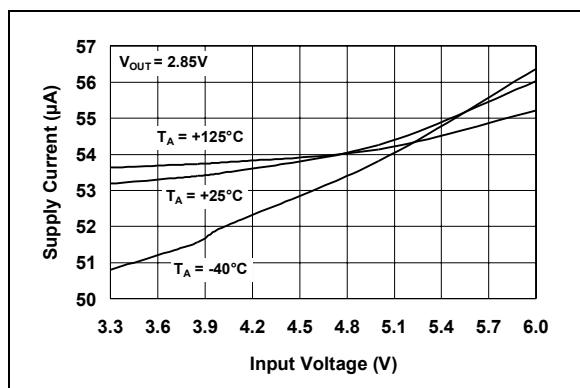

FIGURE 2-3: Supply Current vs. Input Voltage.

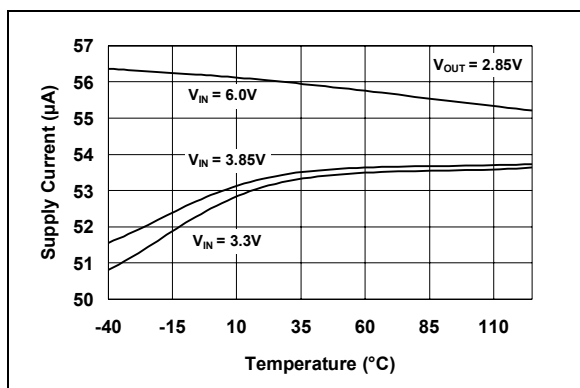

FIGURE 2-6: Supply Current vs. Temperature.

Note: Unless otherwise noted, $V_{IN} = V_R + 1V$, $I_L = 100 \mu A$, $C_L = 1.0 \mu F$, $\overline{SHDN} > V_{IH}$, $T_A = +25^\circ C$.

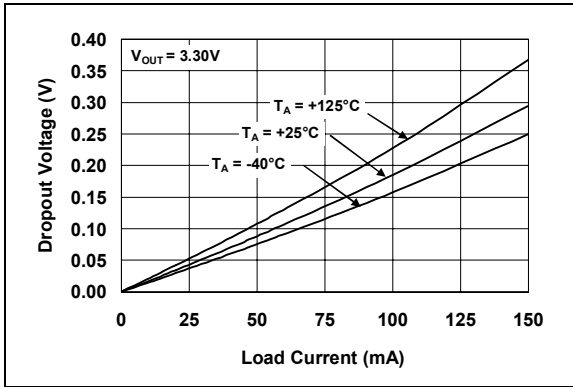

FIGURE 2-7: Dropout Voltage vs. Output Current.

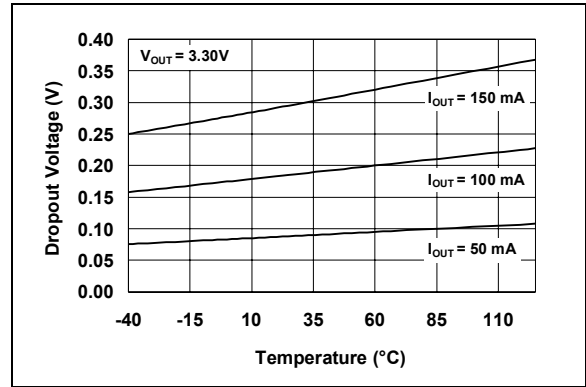

FIGURE 2-10: Dropout Voltage vs. Temperature.

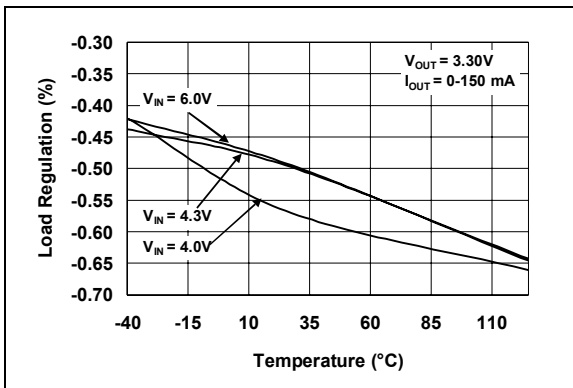

FIGURE 2-8: Load Regulation vs. Temperature.

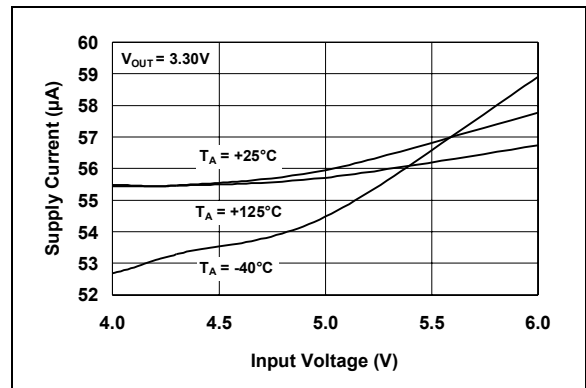

FIGURE 2-11: Supply Current vs. Input Voltage.

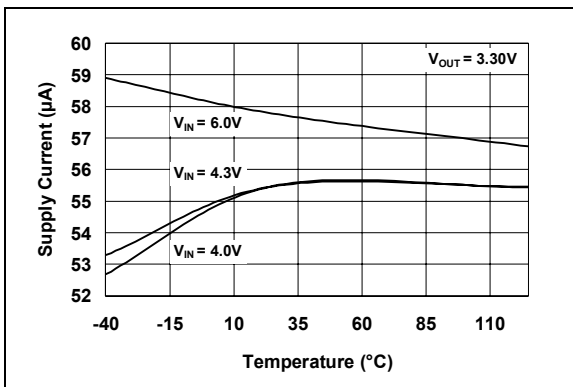

FIGURE 2-9: Supply Current vs. Temperature.

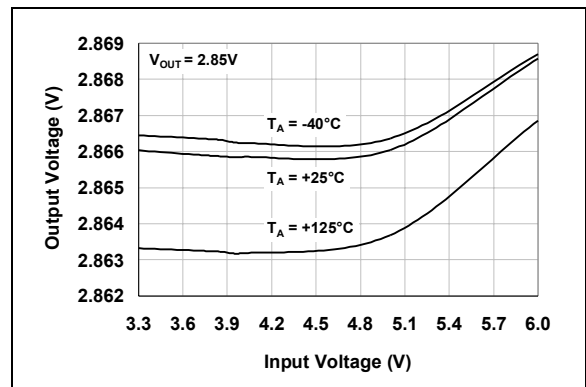

FIGURE 2-12: Output Voltage vs. Supply Voltage.

TC1017

Note: Unless otherwise noted, $V_{IN} = V_R + 1V$, $I_L = 100 \mu A$, $C_L = 1.0 \mu F$, $\overline{SHDN} > V_{IH}$, $T_A = +25^\circ C$.

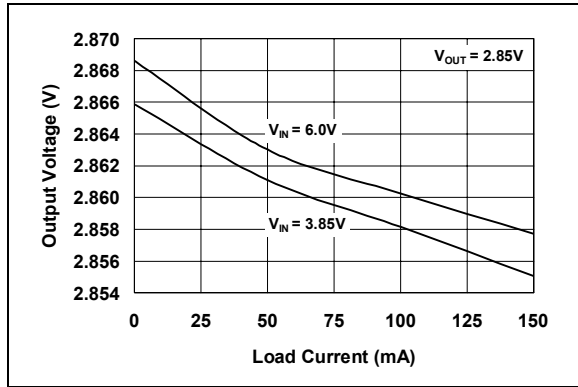

FIGURE 2-13: Output Voltage vs. Output Current.

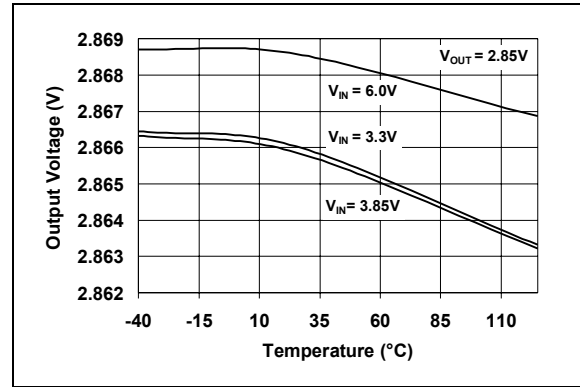

FIGURE 2-16: Output Voltage vs. Temperature.

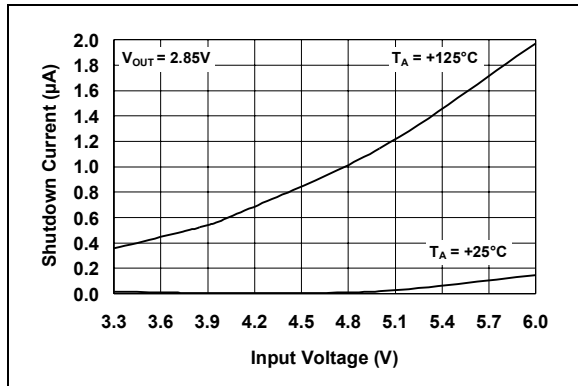

FIGURE 2-14: Shutdown Current vs. Input Voltage.

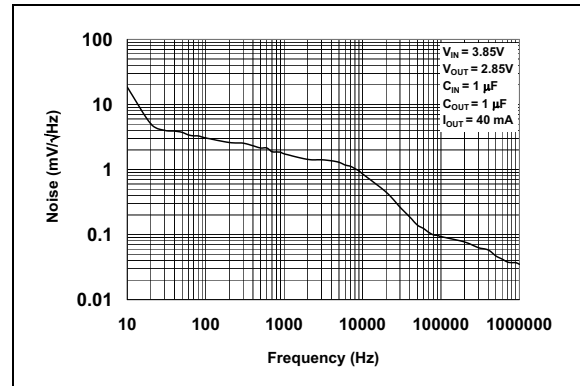

FIGURE 2-17: Output Noise vs. Frequency.

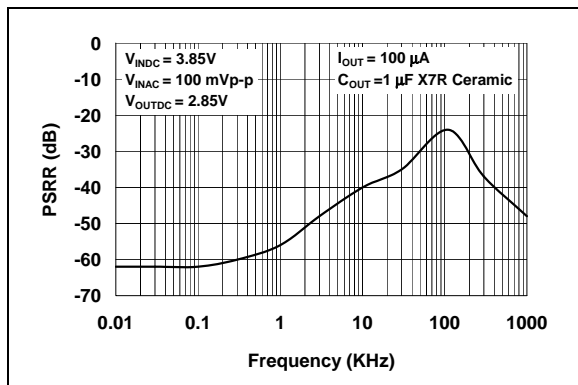

FIGURE 2-15: Power Supply Rejection Ratio vs. Frequency.

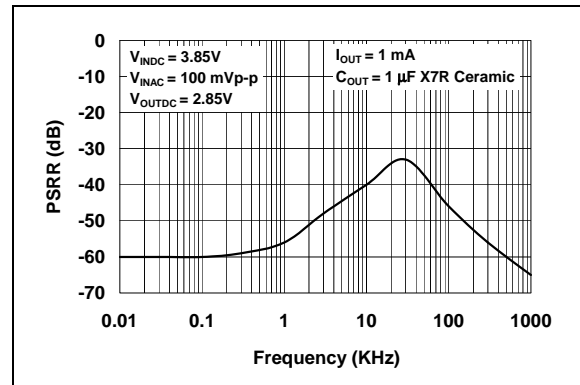

FIGURE 2-18: Power Supply Rejection Ratio vs. Frequency.

Note: Unless otherwise noted, $V_{IN} = V_R + 1V$, $I_L = 100 \mu A$, $C_L = 1.0 \mu F$, $\overline{SHDN} > V_{IH}$, $T_A = +25^\circ C$.

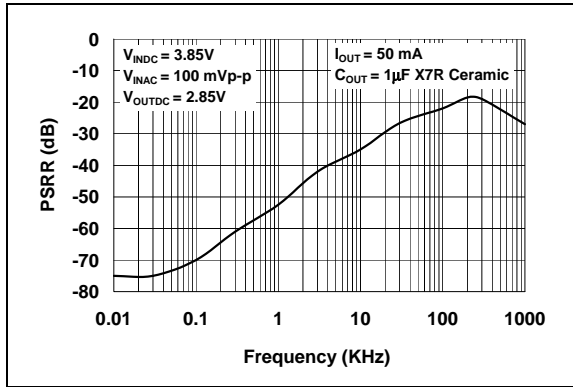

FIGURE 2-19: Power Supply Rejection Ratio vs. Frequency.

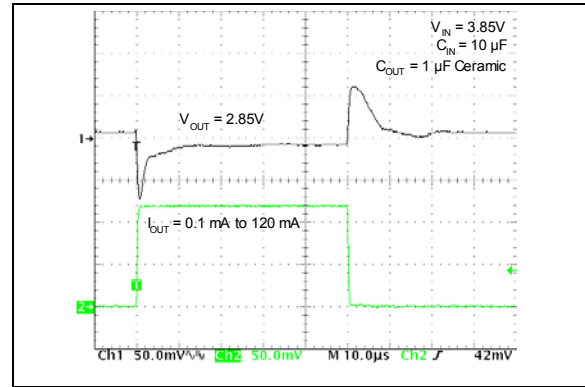

FIGURE 2-22: Load Transient Response.

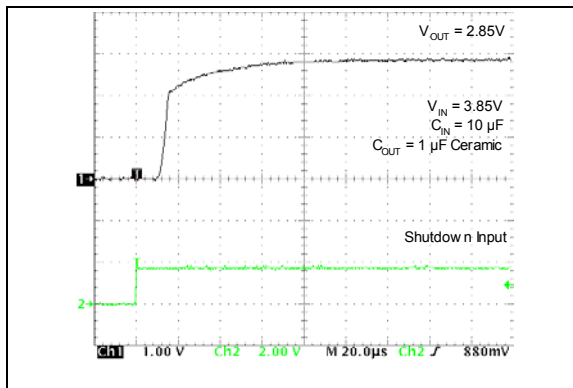

FIGURE 2-20: Wake-Up Response.

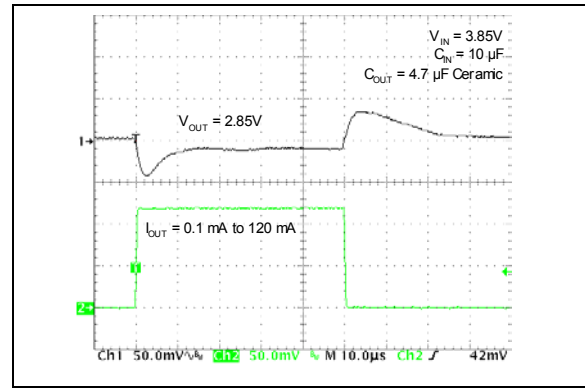

FIGURE 2-23: Load Transient Response.

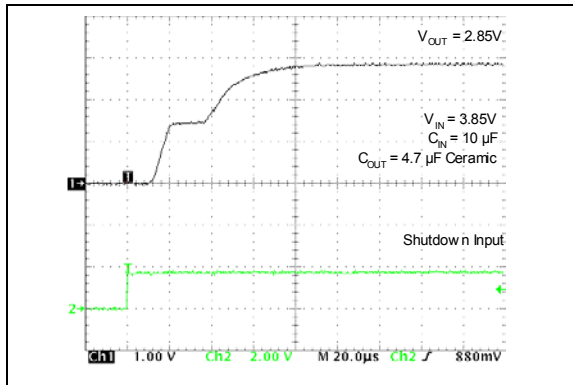

FIGURE 2-21: Wake-Up Response.

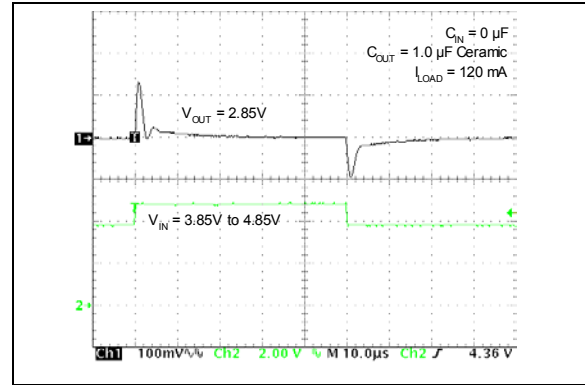

FIGURE 2-24: Line Transient Response.

TC1017

Note: Unless otherwise noted, $V_{IN} = V_R + 1V$, $I_L = 100 \mu A$, $C_L = 1.0 \mu F$, $\overline{SHDN} > V_{IH}$, $T_A = +25^\circ C$.

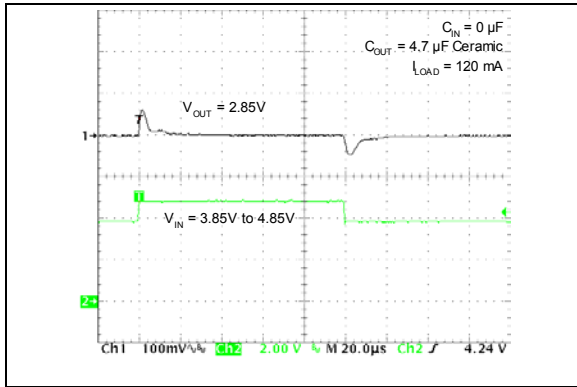

FIGURE 2-25: Line Transient Response.

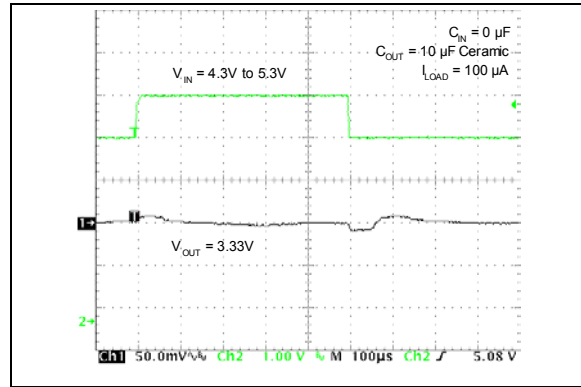

FIGURE 2-27: Line Transient Response.

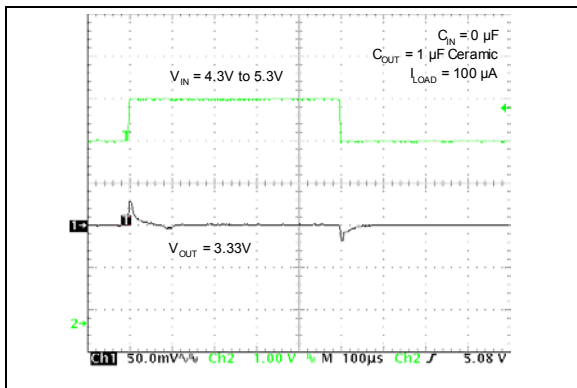

FIGURE 2-26: Line Transient Response.

3.0 PIN DESCRIPTIONS

The descriptions of the pins are listed in Table 3-1.

TABLE 3-1: PIN FUNCTION TABLE

Pin No. (5-Pin SC-70)	Pin No. (5-Pin SOT-23)	Symbol	Description
1	3	$\overline{\text{SHDN}}$	Shutdown Control Input
2	4	NC	No Connect
3	2	GND	Ground Terminal
4	5	V_{OUT}	Regulated Voltage Output
5	1	V_{IN}	Unregulated Supply Input

3.1 Shutdown Control Input ($\overline{\text{SHDN}}$)

The regulator is fully enabled when a logic-high is applied to $\overline{\text{SHDN}}$. The regulator enters shutdown when a logic-low is applied to this input. During shutdown, output voltage falls to zero, and supply current is reduced to 0.05 μA (typ.)

3.2 Ground Terminal

For best performance, it is recommended that the ground pin be tied to a ground plane.

3.3 Regulated Voltage Output (V_{OUT})

Bypass the regulated voltage output to GND with a minimum capacitance of 1 μF . A ceramic bypass capacitor is recommended for best performance.

3.4 Unregulated Supply Input (V_{IN})

The minimum V_{IN} has to meet two conditions in order to ensure that the output maintains regulation: $V_{\text{IN}} \geq 2.7\text{V}$ and $V_{\text{IN}} \geq [(V_{\text{R}} + 2.5\%) + V_{\text{DROPOUT}}]$. The maximum V_{IN} should be less than or equal to 6V. Power dissipation may limit V_{IN} to a lower potential in order to maintain a junction temperature below 125°C. Refer to **Section 5.0, "Thermal Considerations"**, for determining junction temperature.

It is recommended that V_{IN} be bypassed to GND with a ceramic capacitor.

TC1017

4.0 DETAILED DESCRIPTION

The TC1017 is a precision, fixed-output, linear voltage regulator. The internal linear pass element is a P-Channel MOSFET. As with all P-Channel CMOS LDOs, there is a body drain diode with the cathode connected to V_{IN} and the anode connected to V_{OUT} (Figure 4-1).

As is shown in Figure 4-1, the output voltage of the LDO is sensed and divided down internally to reduce external component count. The internal error amplifier has a fixed bandgap reference on the inverting input and the sensed output voltage on the non-inverting input. The error amplifier output will pull the gate voltage down until the inputs of the error amplifier are equal to regulate the output voltage.

By sensing the current in the P-Channel MOSFET, the maximum current delivered to the load is limited to a typical average value of 120 mA, preventing excessive current from damaging the printed circuit board in the event of a shorted or faulted load.

An internal thermal sensing device is used to monitor the junction temperature of the LDO. When the sensed temperature is over the set threshold of 160°C (typical), the P-Channel MOSFET is turned off. When the P-Channel is off, the power dissipation internal to the device is almost zero. The device cools until the junction temperature is approximately 150°C and the

P-Channel is turned on. If the internal power dissipation is still high enough for the junction to rise to 160°C, it will again shut off and cool. The maximum operating junction temperature of the device is 125°C. Steady-state operation at or near the 160°C overtemperature point can lead to permanent damage of the device.

The output voltage V_{OUT} remains stable over the entire input operating voltage range (2.7V to 6.0V) and the entire load range (0 mA to 150 mA). The output voltage is sensed through an internal resistor divider and compared with a precision internal voltage reference. Several fixed-output voltages are available by changing the value of the internal resistor divider.

Figure 4-2 shows a typical application circuit. The regulator is enabled any time the shutdown input pin is at or above V_{IH} . It is shut down (disabled) any time the shutdown input pin is below V_{IL} . For applications where the SHDN feature is not used, tie the SHDN pin directly to the input supply voltage source. While in shutdown, the supply current decreases to 0.006 μ A (typical) and the P-Channel MOSFET is turned off.

As shown in Figure 4-2, batteries have internal source impedance. An input capacitor is used to lower the input impedance of the LDO. In some applications, high input impedance can cause the LDO to become unstable. Adding more input capacitance can compensate for this.

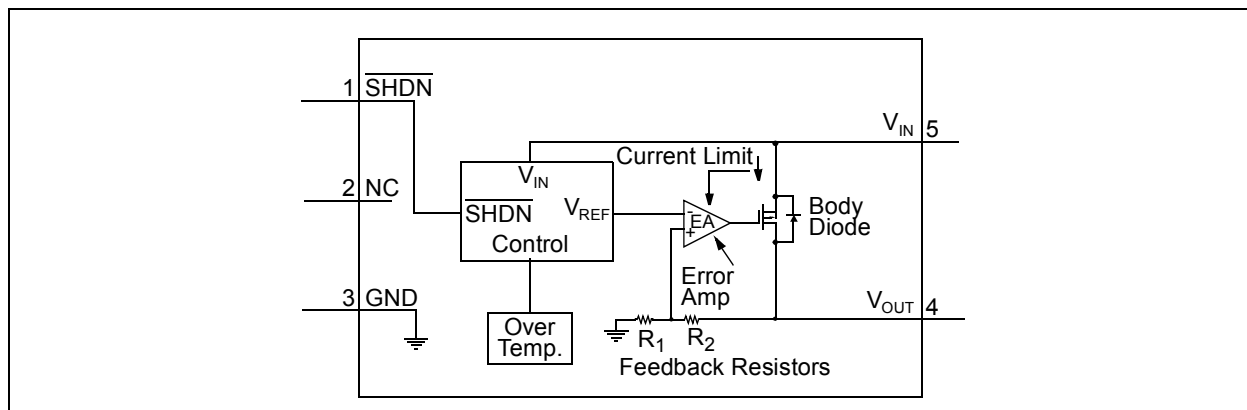

FIGURE 4-1: TC1017 Block Diagram.

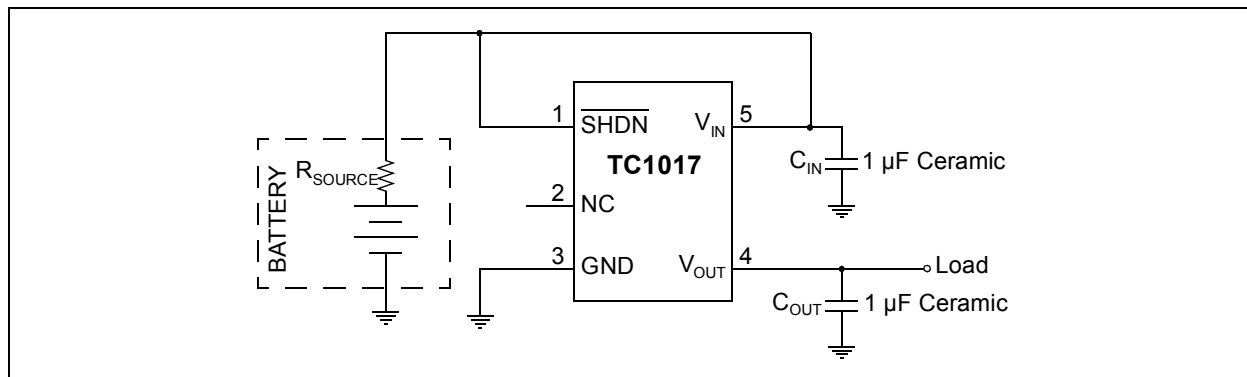

FIGURE 4-2: Typical Application Circuit.

4.1 Input Capacitor

Low input source impedance is necessary for the LDO to operate properly. When operating from batteries, or in applications with long lead length (> 10") between the input source and the LDO, some input capacitance is required. A minimum of 0.1 μF is recommended for most applications and the capacitor should be placed as close to the input of the LDO as is practical. Larger input capacitors will help reduce the input impedance and further reduce any high-frequency noise on the input and output of the LDO.

4.2 Output Capacitor

A minimum output capacitance of 1 μF for the TC1017 is required for stability. The equivalent series resistance (ESR) requirements on the output capacitor are between 0 and 2 ohms. The output capacitor should be located as close to the LDO output as is practical. Ceramic materials X7R and X5R have low temperature coefficients and are well within the acceptable ESR range required. A typical 1 μF X5R 0805 capacitor has an ESR of 50 milli-ohms. Larger output capacitors can be used with the TC1017 to improve dynamic behavior and input ripple-rejection performance.

Ceramic, aluminum electrolytic or tantalum capacitor types can be used. Since many aluminum electrolytic capacitors freeze at approximately -30°C , ceramic or solid tantalums are recommended for applications operating below -25°C . When operating from sources other than batteries, supply-noise rejection and transient response can be improved by increasing the value of the input and output capacitors and employing passive filtering techniques.

4.3 Turn-On Response

The turn-on response is defined as two separate response categories, wake-up time (t_{WK}) and settling time (t_{S}).

The TC1017 has a fast wake-up time (10 μsec , typical) when released from shutdown. See Figure 4-3 for the wake-up time designated as t_{WK} . The wake-up time is defined as the time it takes for the output to rise to 2% of the V_{OUT} value after being released from shutdown.

The total turn-on response is defined as the settling time (t_{S}) (see Figure 4-3). Settling time (inclusive with t_{WK}) is defined as the condition when the output is within 98% of its fully-enabled value (32 μsec , typical) when released from shutdown. The settling time of the output voltage is dependent on load conditions and output capacitance on V_{OUT} (RC response).

The table below demonstrates the typical turn-on response timing for different input voltage power-up frequencies: $V_{\text{OUT}} = 2.85\text{V}$, $V_{\text{IN}} = 5.0\text{V}$, $I_{\text{OUT}} = 60\text{mA}$ and $C_{\text{OUT}} = 1\ \mu\text{F}$.

Frequency	Typical (t_{WK})	Typical (t_{S})
1000 Hz	5.3 μsec	14 μsec
500 Hz	5.9 μsec	16 μsec
100 Hz	9.8 μsec	32 μsec
50 Hz	14.5 μsec	52 μsec
10 Hz	17.2 μsec	77 μsec

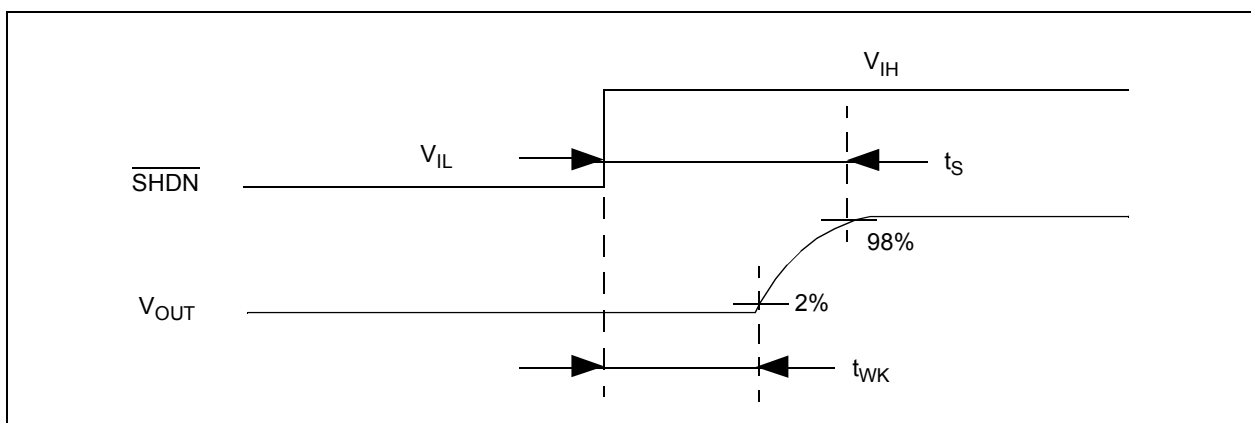

FIGURE 4-3: Wake-Up Time from Shutdown.

5.0 THERMAL CONSIDERATIONS

5.1 Thermal Shutdown

Integrated thermal protection circuitry shuts the regulator off when die temperature exceeds approximately 160°C. The regulator remains off until the die temperature drops to approximately 150°C.

5.2 Power Dissipation: SC-70

The TC1017 is available in the SC-70 package. The thermal resistance for the SC-70 package is approximately 450°C/W when the copper area used in the printed circuit board layout is similar to the JEDEC J51-7 high thermal conductivity standard or semi-G42-88 standard. For applications with larger or thicker copper area, the thermal resistance can be lowered. See AN792, "A Method to Determine How Much Power a SOT-23 Can Dissipate in an Application", DS00792, for a method to determine the thermal resistance for a particular application.

The TC1017 power dissipation capability is dependant upon several variables: input voltage, output voltage, load current, ambient temperature and maximum junction temperature. The absolute maximum steady-state junction temperature is rated at +125°C. The power dissipation within the device is equal to:

EQUATION:

$$P_D = (V_{IN} - V_{OUT}) \times I_{LOAD} + V_{IN} \times I_{GND}$$

The $V_{IN} \times I_{GND}$ term is typically very small when compared to the $(V_{IN} - V_{OUT}) \times I_{LOAD}$ term, simplifying the power dissipation within the LDO to be:

EQUATION:

$$P_D = (V_{IN} - V_{OUT}) \times I_{LOAD}$$

To determine the maximum power dissipation capability, the following equation is used:

EQUATION:

$$P_{D_{MAX}} = \frac{(T_{J_{MAX}} - T_{A_{MAX}})}{R\theta_{JA}}$$

Where:

$T_{J_{MAX}}$ = the maximum junction temperature allowed

$T_{A_{MAX}}$ = the maximum ambient temperature

$R\theta_{JA}$ = the thermal resistance from junction to air

Given the following example:

$$V_{IN} = 3.0V \text{ to } 4.1V$$

$$V_{OUT} = 2.85V \pm 2.5\%$$

$$I_{LOAD} = 120 \text{ mA (output current)}$$

$$T_A = 55^\circ\text{C (max. desired ambient)}$$

Find:

1. Internal power dissipation:

$$\begin{aligned} P_{D_{MAX}} &= (V_{IN_{MAX}} - V_{OUT_{MIN}}) \times I_{LOAD} \\ &= (4.1V - 2.85 \times (0.975)) \times 120mA \\ &= 158.5mW \end{aligned}$$

2. Maximum allowable ambient temperature:

$$\begin{aligned} T_{A_{MAX}} &= T_{J_{MAX}} - P_{D_{MAX}} \times R\theta_{JA} \\ &= (125^\circ\text{C} - 158.5mW \times 450^\circ\text{C/W}) \\ &= (125^\circ\text{C} - 71^\circ\text{C}) \\ &= 54^\circ\text{C} \end{aligned}$$

3. Maximum allowable power dissipation at desired ambient:

$$\begin{aligned} P_D &= \frac{T_{J_{MAX}} - T_A}{R\theta_{JA}} \\ &= \frac{125^\circ\text{C} - 55^\circ\text{C}}{450^\circ\text{C/W}} \\ &= 155mW \end{aligned}$$

In this example, the TC1017 dissipates approximately 158.5 mW and the junction temperature is raised 71°C over the ambient. The absolute maximum power dissipation is 155 mW when given a maximum ambient temperature of 55°C.

Input voltage, output voltage or load current limits can also be determined by substituting known values in the power dissipation equations.

Figure 5-1 and Figure 5-2 depict typical maximum power dissipation versus ambient temperature and typical maximum current versus ambient temperature, with a one volt input voltage to output voltage differential, respectively.

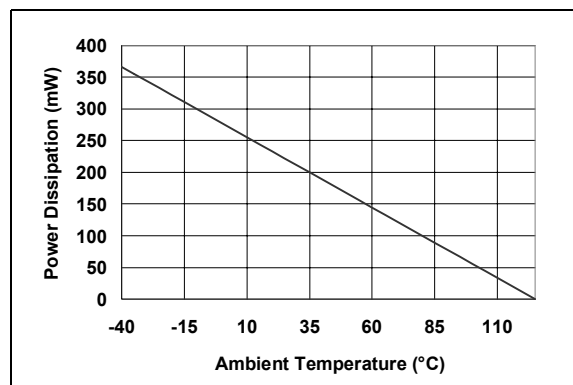

FIGURE 5-1: Power Dissipation vs. Ambient Temperature (SC-70 package).

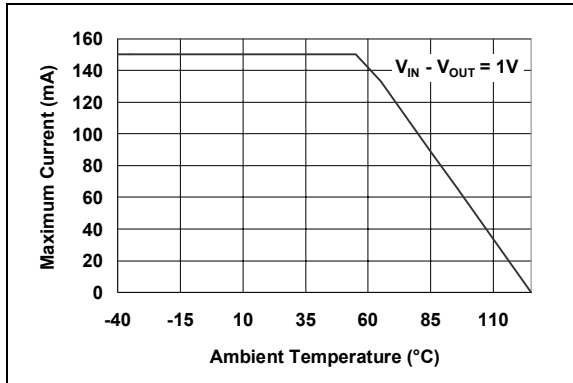

FIGURE 5-2: Maximum Current vs. Ambient Temperature (SC-70 package).

5.3 Power Dissipation: SOT-23

The TC1017 is also available in a SOT-23 package for improved thermal performance. The thermal resistance for the SOT-23 package is approximately 255°C/W when the copper area used in the printed circuit board layout is similar to the JEDEC J51-7 low thermal conductivity standard or semi-G42-88 standard. For applications with larger or thicker copper area, the thermal resistance can be lowered. See AN792, "A Method to Determine How Much Power a SOT-23 Can Dissipate in an Application", DS00792, for a method to determine the thermal resistance for a particular application.

The TC1017 power dissipation capability is dependant upon several variables: input voltage, output voltage, load current, ambient temperature and maximum junction temperature. The absolute maximum steady-state junction temperature is rated at +125°C. The power dissipation within the device is equal to:

EQUATION:

$$P_D = (V_{IN} - V_{OUT}) \times I_{LOAD} + V_{IN} \times I_{GND}$$

The $V_{IN} \times I_{GND}$ term is typically very small when compared to the $(V_{IN} - V_{OUT}) \times I_{LOAD}$ term, simplifying the power dissipation within the LDO to be:

EQUATION:

$$P_D = (V_{IN} - V_{OUT}) \times I_{LOAD}$$

To determine the maximum power dissipation capability, the following equation is used:

EQUATION:

$$P_{DMAX} = \frac{(T_{J_MAX} - T_{A_MAX})}{R\theta_{JA}}$$

Where:

T_{J_MAX} = the maximum junction temperature allowed

T_{A_MAX} = the maximum ambient temperature

$R\theta_{JA}$ = the thermal resistance from junction to air

Given the following example:

$$V_{IN} = 3.0V \text{ to } 4.1V$$

$$V_{OUT} = 2.85V \pm 2.5\%$$

$$I_{LOAD} = 120 \text{ mA (output current)}$$

$$T_A = +85^\circ\text{C (max. desired ambient)}$$

Find:

1. Internal power dissipation:

$$\begin{aligned} P_{DMAX} &= (V_{IN_MAX} - V_{OUT_MIN}) \times I_{LOAD} \\ &= (4.1V - 2.85 \times (0.975)) \times 120mA \\ &= 158.5mW \end{aligned}$$

2. Maximum allowable ambient temperature:

$$\begin{aligned} T_{A_MAX} &= T_{J_MAX} - P_{DMAX} \times R\theta_{JA} \\ &= (125^\circ\text{C} - 158.5mW \times 255^\circ\text{C/W}) \\ &= (125^\circ\text{C} - 40.5^\circ\text{C}) \\ &= 84.5^\circ\text{C} \end{aligned}$$

3. Maximum allowable power dissipation at desired ambient:

$$\begin{aligned} P_D &= \frac{T_{J_MAX} - T_A}{R\theta_{JA}} \\ &= \frac{125^\circ\text{C} - 85^\circ\text{C}}{255^\circ\text{C/W}} \\ &= 157mW \end{aligned}$$

In this example, the TC1017 dissipates approximately 158.5 mWatts and the junction temperature is raised 40.5°C over the ambient. The absolute maximum power dissipation is 157 mW when given a maximum ambient temperature of +85°C.

Input voltage, output voltage or load current limits can also be determined by substituting known values in the power dissipation equations.

Figure 5-3 and Figure 5-4 depict typical maximum power dissipation versus ambient temperature and typical maximum current versus ambient temperature with a one volt input voltage to output voltage differential, respectively.

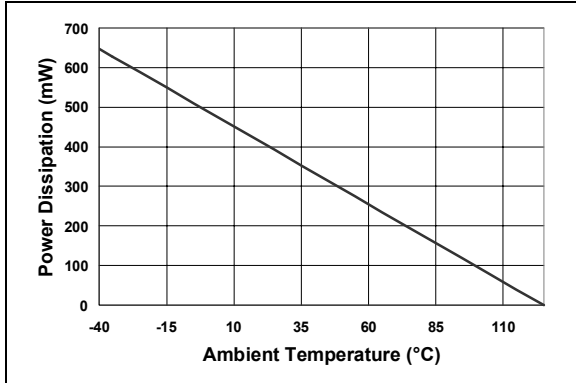

FIGURE 5-3: Power Dissipation vs. Ambient Temperature (SOT-23 Package).

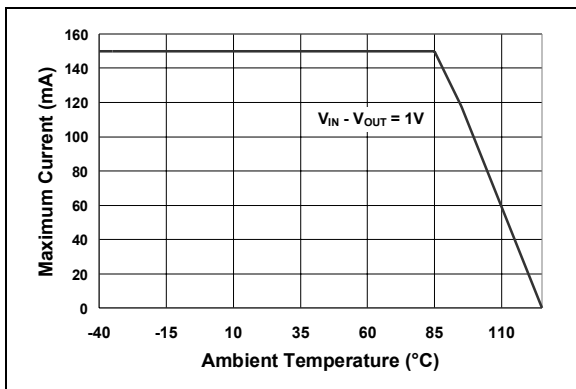

FIGURE 5-4: Maximum Current vs. Ambient Temperature (SOT-23 Package).

5.4 Layout Considerations

The primary path for heat conduction out of the SC-70 or SOT-23 package is through the package leads. Using heavy wide traces at the pads of the device will facilitate the removal of the heat within the package, thus lowering the thermal resistance $R\theta_{JA}$. By lowering the thermal resistance, the maximum internal power dissipation capability of the package is increased.

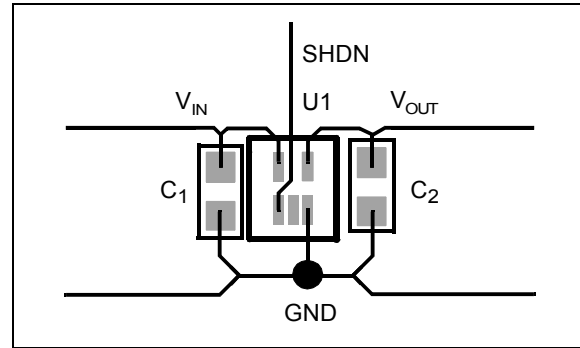
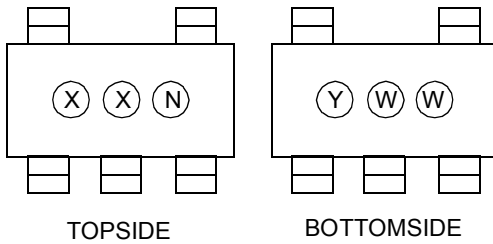

FIGURE 5-5: SC-70 Package Suggested Layout.

6.0 PACKAGE INFORMATION

6.1 Package Marking Information

5-Pin SC-70



Part Number	Code
TC1017 - 1.8VLT	CE
TC1017 - 2.6VLT	CF
TC1017 - 2.7VLT	CG
TC1017 - 2.8VLT	CH
TC1017 - 2.85VLT	CJ
TC1017 - 2.9VLT	CK
TC1017 - 3.0VLT	CL
TC1017 - 3.3VLT	CM
TC1017 - 4.0VLT	CP

5-Lead SOT-23



Part Number	Code
TC1017 - 1.8VCT	DA
TC1017 - 2.6VCT	DB
TC1017 - 2.7VCT	DC
TC1017 - 2.8VCT	DD
TC1017 - 2.85VCT	DE
TC1017 - 2.9VCT	DF
TC1017 - 3.0VCT	DG
TC1017 - 3.3VCT	DH
TC1017 - 4.0VCT	DJ

Legend:	XX...X	Customer specific information*
	Y	Year code (last digit of calendar year)
	YY	Year code (last 2 digits of calendar year)
	WW	Week code (week of January 1 is week '01')
	NNN	Alphanumeric traceability code

Note: In the event the full Microchip part number cannot be marked on one line, it will be carried over to the next line thus limiting the number of available characters for customer specific information.

* Standard device marking consists of Microchip part number, year code, week code, and traceability code.

TC1017

5-Lead Plastic Small Outline Transistor (LT) (SC-70)

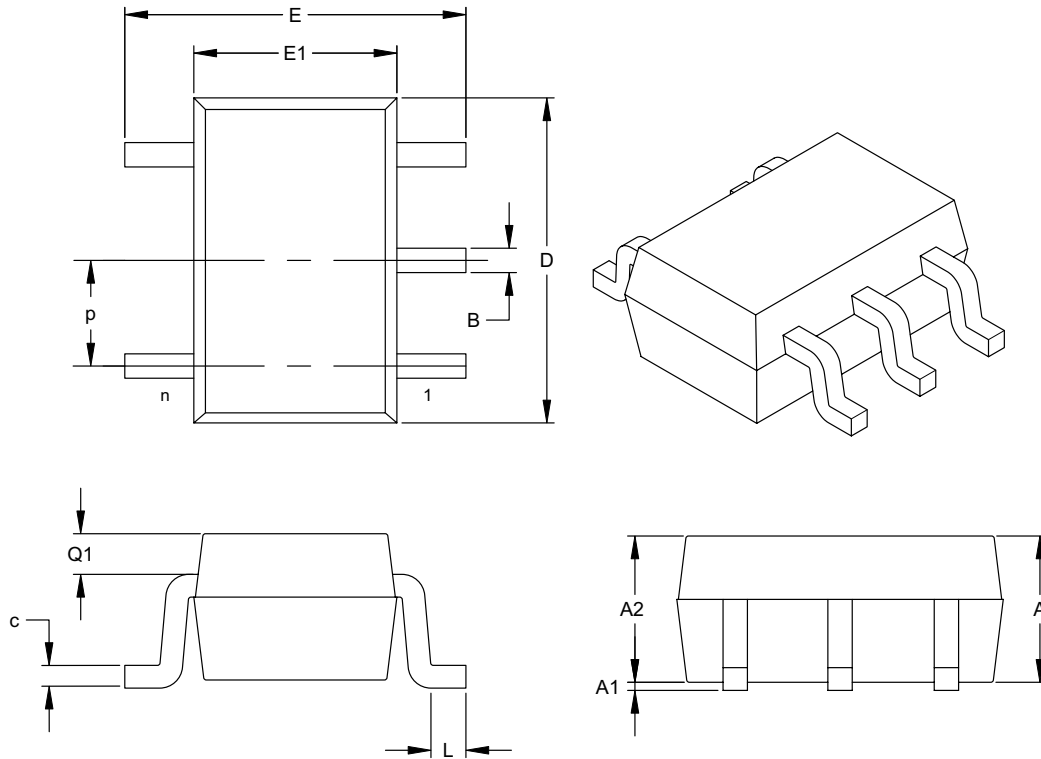

Dimension	Units	INCHES			MILLIMETERS*		
		MIN	NOM	MAX	MIN	NOM	MAX
Number of Pins	n	5			5		
Pitch	p	.026 (BSC)			0.65 (BSC)		
Overall Height	A	.031		.043	0.80		1.10
Molded Package Thickness	A2	.031		.039	0.80		1.00
Standoff	A1	.000		.004	0.00		0.10
Overall Width	E	.071		.094	1.80		2.40
Molded Package Width	E1	.045		.053	1.15		1.35
Overall Length	D	.071		.087	1.80		2.20
Foot Length	L	.004		.012	0.10		0.30
Top of Molded Pkg to Lead Shoulder	Q1	.004		.016	0.10		0.40
Lead Thickness	c	.004		.007	0.10		0.18
Lead Width	B	.006		.012	0.15		0.30

*Controlling Parameter

Notes:

Dimensions D and E1 do not include mold flash or protrusions. Mold flash or protrusions shall not exceed .005" (0.127mm) per side.

JEITA (EIAJ) Standard: SC-70

Drawing No. C04-061

5-Lead Plastic Small Outline Transistor (OT) (SOT-23)

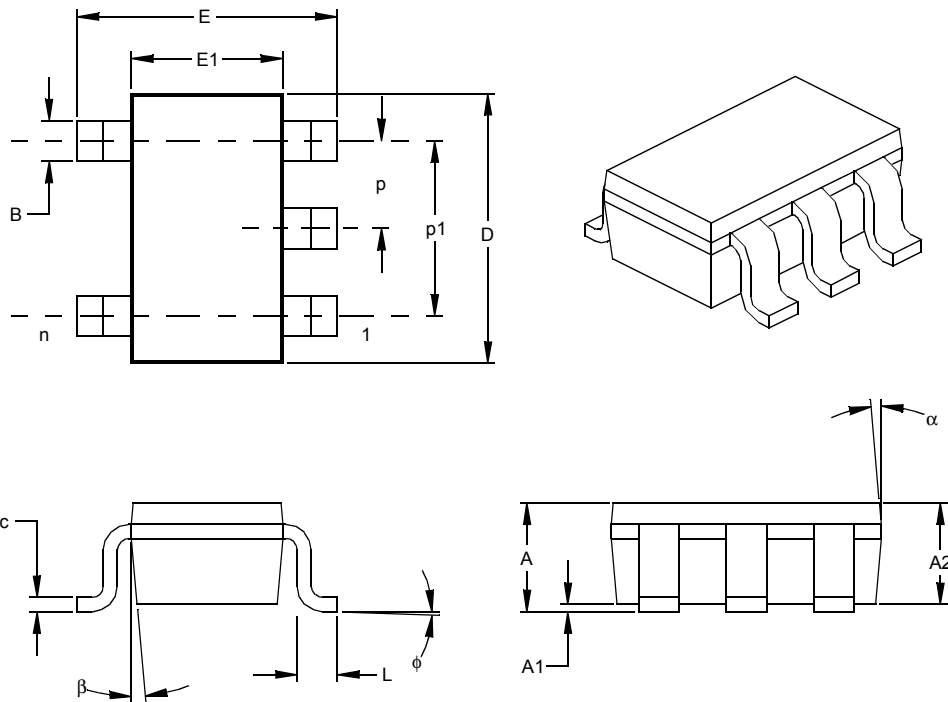

Units		INCHES*			MILLIMETERS		
Dimension	Limits	MIN	NOM	MAX	MIN	NOM	MAX
Number of Pins	n		5			5	
Pitch	p		.038			0.95	
Outside lead pitch (basic)	p1		.075			1.90	
Overall Height	A	.035	.046	.057	0.90	1.18	1.45
Molded Package Thickness	A2	.035	.043	.051	0.90	1.10	1.30
Standoff §	A1	.000	.003	.006	0.00	0.08	0.15
Overall Width	E	.102	.110	.118	2.60	2.80	3.00
Molded Package Width	E1	.059	.064	.069	1.50	1.63	1.75
Overall Length	D	.110	.116	.122	2.80	2.95	3.10
Foot Length	L	.014	.018	.022	0.35	0.45	0.55
Foot Angle	φ	0	5	10	0	5	10
Lead Thickness	c	.004	.006	.008	0.09	0.15	0.20
Lead Width	B	.014	.017	.020	0.35	0.43	0.50
Mold Draft Angle Top	α	0	5	10	0	5	10
Mold Draft Angle Bottom	β	0	5	10	0	5	10

* Controlling Parameter
 § Significant Characteristic

Notes:

Dimensions D and E1 do not include mold flash or protrusions. Mold flash or protrusions shall not exceed .010" (0.254mm) per side.

JEDEC Equivalent: MO-178

Drawing No. C04-091

TC1017

NOTES:

PRODUCT IDENTIFICATION SYSTEM

To order or obtain information, e.g., on pricing or delivery, refer to the factory or the listed sales office.

PART NO.	XX	X	Examples:
Device	Voltage Range	Temperature Range	
Device:	TC1017: 150 mA Tiny CMOS LDO with Shutdown		a) TC1017-1.8VLTR: 150 mA, Tiny CMOS LDO with Shutdown, SC-70 package.
Voltage Range:	SC-70 Package	SOT-23 Package	b) TC1017-2.6VCTTR: 150 mA, Tiny CMOS LDO with Shutdown, SOT-23 package.
	CE = 1.8V	DA = 1.8V	c) TC1017-2.7VLTR: 150 mA, Tiny CMOS LDO with Shutdown, SC-70 package.
	CF = 2.6V	DB = 2.6V	d) TC1017-2.8VCTTR: 150 mA, Tiny CMOS LDO with Shutdown, SOT-23 package.
	CG = 2.7V	DC = 2.7V	e) TC1017-2.85VLTR: 150 mA, Tiny CMOS LDO with Shutdown, SC-70 package.
	CH = 2.8V	DD = 2.8V	f) TC1017-2.9VCTTR: 150 mA, Tiny CMOS LDO with Shutdown, SOT-23 package.
	CJ = 2.85V	DE = 2.85V	g) TC1017-3.0VLTR: 150 mA, Tiny CMOS LDO with Shutdown, SC-70 package.
	CK = 2.9V	DF = 2.9V	h) TC1017-3.3VCTTR: 150 mA, Tiny CMOS LDO with Shutdown, SOT-23 package.
	CL = 3.0V	DG = 3.0V	i) TC1017-4.0VLTR: 150 mA, Tiny CMOS LDO with Shutdown, SC-70 package.
	CM = 3.3V	DH = 3.3V	
	CP = 4.0V	DJ = 4.0V	
Temperature Range:	V = -40°C to +125°C		
Package:	LTTR = 5-pin SC-70 (Tape and Reel) CTTR = 5-pin SOT-23 (Tape and Reel)		

Sales and Support

Data Sheets

Products supported by a preliminary Data Sheet may have an errata sheet describing minor operational differences and recommended workarounds. To determine if an errata sheet exists for a particular device, please contact one of the following:

1. Your local Microchip sales office
2. The Microchip Corporate Literature Center U.S. FAX: (480) 792-7277
3. The Microchip Worldwide Site (www.microchip.com)

Please specify which device, revision of silicon and Data Sheet (include Literature #) you are using.

Customer Notification System

Register on our web site (www.microchip.com/cn) to receive the most current information on our products.

TC1017

NOTES:

Note the following details of the code protection feature on Microchip devices:

- Microchip products meet the specification contained in their particular Microchip Data Sheet.
- Microchip believes that its family of products is one of the most secure families of its kind on the market today, when used in the intended manner and under normal conditions.
- There are dishonest and possibly illegal methods used to breach the code protection feature. All of these methods, to our knowledge, require using the Microchip products in a manner outside the operating specifications contained in Microchip's Data Sheets. Most likely, the person doing so is engaged in theft of intellectual property.
- Microchip is willing to work with the customer who is concerned about the integrity of their code.
- Neither Microchip nor any other semiconductor manufacturer can guarantee the security of their code. Code protection does not mean that we are guaranteeing the product as "unbreakable."

Code protection is constantly evolving. We at Microchip are committed to continuously improving the code protection features of our products. Attempts to break microchip's code protection feature may be a violation of the Digital Millennium Copyright Act. If such acts allow unauthorized access to your software or other copyrighted work, you may have a right to sue for relief under that Act.

Information contained in this publication regarding device applications and the like is intended through suggestion only and may be superseded by updates. It is your responsibility to ensure that your application meets with your specifications. No representation or warranty is given and no liability is assumed by Microchip Technology Incorporated with respect to the accuracy or use of such information, or infringement of patents or other intellectual property rights arising from such use or otherwise. Use of Microchip's products as critical components in life support systems is not authorized except with express written approval by Microchip. No licenses are conveyed, implicitly or otherwise, under any intellectual property rights.

Trademarks

The Microchip name and logo, the Microchip logo, Accuron, dsPIC, KEELoQ, MPLAB, PIC, PICmicro, PICSTART, PRO MATE and PowerSmart are registered trademarks of Microchip Technology Incorporated in the U.S.A. and other countries.

AmpLab, FilterLab, microID, MXDEV, MXLAB, PICMASTER, SEEVAL and The Embedded Control Solutions Company are registered trademarks of Microchip Technology Incorporated in the U.S.A.

Application Maestro, dsPICDEM, dsPICDEM.net, ECAN, ECONOMONITOR, FanSense, FlexROM, fuzzyLAB, In-Circuit Serial Programming, ICSP, ICEPIC, microPort, Migratable Memory, MPASM, MPLIB, MPLINK, MPSIM, PICKit, PICDEM, PICDEM.net, PowerCal, PowerInfo, PowerMate, PowerTool, rLAB, rPIC, Select Mode, SmartSensor, SmartShunt, SmartTel and Total Endurance are trademarks of Microchip Technology Incorporated in the U.S.A. and other countries.

Serialized Quick Turn Programming (SQTP) is a service mark of Microchip Technology Incorporated in the U.S.A.

All other trademarks mentioned herein are property of their respective companies.

© 2003, Microchip Technology Incorporated, Printed in the U.S.A., All Rights Reserved.

 Printed on recycled paper.

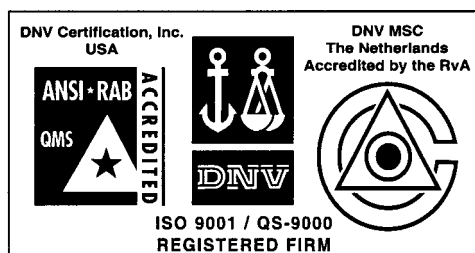

Microchip received QS-9000 quality system certification for its worldwide headquarters, design and wafer fabrication facilities in Chandler and Tempe, Arizona in July 1999 and Mountain View, California in March 2002. The Company's quality system processes and procedures are QS-9000 compliant for its PICmicro® 8-bit MCUs, KEELoQ® code hopping devices, Serial EEPROMs, microperipherals, non-volatile memory and analog products. In addition, Microchip's quality system for the design and manufacture of development systems is ISO 9001 certified.



WORLDWIDE SALES AND SERVICE

AMERICAS

Corporate Office

2355 West Chandler Blvd.
Chandler, AZ 85224-6199
Tel: 480-792-7200
Fax: 480-792-7277
Technical Support: 480-792-7627
Web Address: <http://www.microchip.com>

Atlanta

3780 Mansell Road, Suite 130
Alpharetta, GA 30022
Tel: 770-640-0034
Fax: 770-640-0307

Boston

2 Lan Drive, Suite 120
Westford, MA 01886
Tel: 978-692-3848
Fax: 978-692-3821

Chicago

333 Pierce Road, Suite 180
Itasca, IL 60143
Tel: 630-285-0071
Fax: 630-285-0075

Dallas

4570 Westgrove Drive, Suite 160
Addison, TX 75001
Tel: 972-818-7423
Fax: 972-818-2924

Detroit

Tri-Atria Office Building
32255 Northwestern Highway, Suite 190
Farmington Hills, MI 48334
Tel: 248-538-2250
Fax: 248-538-2260

Kokomo

2767 S. Albright Road
Kokomo, IN 46902
Tel: 765-864-8360
Fax: 765-864-8387

Los Angeles

18201 Von Karman, Suite 1090
Irvine, CA 92612
Tel: 949-263-1888
Fax: 949-263-1338

Phoenix

2355 West Chandler Blvd.
Chandler, AZ 85224-6199
Tel: 480-792-7966
Fax: 480-792-4338

San Jose

2107 North First Street, Suite 590
San Jose, CA 95131
Tel: 408-436-7950
Fax: 408-436-7955

Toronto

6285 Northam Drive, Suite 108
Mississauga, Ontario L4V 1X5, Canada
Tel: 905-673-0699
Fax: 905-673-6509

ASIA/PACIFIC

Australia

Suite 22, 41 Rawson Street
Epping 2121, NSW
Australia
Tel: 61-2-9868-6733
Fax: 61-2-9868-6755

China - Beijing

Unit 915
Bei Hai Wan Tai Bldg.
No. 6 Chaoyangmen Beidajie
Beijing, 100027, No. China
Tel: 86-10-85282100
Fax: 86-10-85282104

China - Chengdu

Rm. 2401-2402, 24th Floor,
Ming Xing Financial Tower
No. 88 TIDU Street
Chengdu 610016, China
Tel: 86-28-86766200
Fax: 86-28-86766599

China - Fuzhou

Unit 28F, World Trade Plaza
No. 71 Wusi Road
Fuzhou 350001, China
Tel: 86-591-7503506
Fax: 86-591-7503521

China - Hong Kong SAR

Unit 901-6, Tower 2, Metroplaza
223 Hing Fong Road
Kwai Fong, N.T., Hong Kong
Tel: 852-2401-1200
Fax: 852-2401-3431

China - Shanghai

Room 701, Bldg. B
Far East International Plaza
No. 317 Xian Xia Road
Shanghai, 200051
Tel: 86-21-6275-5700
Fax: 86-21-6275-5060

China - Shenzhen

Rm. 1812, 18/F, Building A, United Plaza
No. 5022 Binhe Road, Futian District
Shenzhen 518033, China
Tel: 86-755-82901380
Fax: 86-755-8295-1393

China - Shunde

Room 401, Hongjian Building
No. 2 Fengxiangnan Road, Ronggui Town
Shunde City, Guangdong 528303, China
Tel: 86-765-8395507 Fax: 86-765-8395571

China - Qingdao

Rm. B505A, Fullhope Plaza,
No. 12 Hong Kong Central Rd.
Qingdao 266071, China
Tel: 86-532-5027355 Fax: 86-532-5027205

India

Divyasree Chambers
1 Floor, Wing A (A3/A4)
No. 11, O'Shaughnessy Road
Bangalore, 560 025, India
Tel: 91-80-2290061 Fax: 91-80-2290062

Japan

Benex S-1 6F
3-18-20, Shinyokohama
Kohoku-Ku, Yokohama-shi
Kanagawa, 222-0033, Japan
Tel: 81-45-471-6166 Fax: 81-45-471-6122

Korea

168-1, Youngbo Bldg. 3 Floor
Samsung-Dong, Kangnam-Ku
Seoul, Korea 135-882
Tel: 82-2-554-7200 Fax: 82-2-558-5932 or
82-2-558-5934

Singapore

200 Middle Road
#07-02 Prime Centre
Singapore, 188980
Tel: 65-6334-8870 Fax: 65-6334-8850

Taiwan

Kaohsiung Branch
30F - 1 No. 8
Min Chuan 2nd Road
Kaohsiung 806, Taiwan
Tel: 886-7-536-4818
Fax: 886-7-536-4803

Taiwan

Taiwan Branch
11F-3, No. 207
Tung Hua North Road
Taipei, 105, Taiwan
Tel: 886-2-2717-7175 Fax: 886-2-2545-0139

EUROPE

Austria

Durisolstrasse 2
A-4600 Wels
Austria
Tel: 43-7242-2244-399
Fax: 43-7242-2244-393

Denmark

Regus Business Centre
Lautrup høj 1-3
Ballerup DK-2750 Denmark
Tel: 45-4420-9895 Fax: 45-4420-9910

France

Parc d'Activite du Moulin de Massy
43 Rue du Saule Trapu
Batiment A - ler Etage
91300 Massy, France
Tel: 33-1-69-53-63-20
Fax: 33-1-69-30-90-79

Germany

Steinheilstrasse 10
D-85737 Ismaning, Germany
Tel: 49-89-627-144-0
Fax: 49-89-627-144-44

Italy

Via Quasimodo, 12
20025 Legnano (MI)
Milan, Italy
Tel: 39-0331-742611
Fax: 39-0331-466781

Netherlands

P. A. De Biesbosch 14
NL-5152 SC Drunen, Netherlands
Tel: 31-416-690399
Fax: 31-416-690340

United Kingdom

505 Eskdale Road
Winnersh Triangle
Wokingham
Berkshire, England RG41 5TU
Tel: 44-118-921-5869
Fax: 44-118-921-5820

07/28/03