



Z00607MA
Z00607DA

SENSITIVE GATE TRIACS

FEATURES

- $I_{T(RMS)} = 0.8A$
- $V_{DRM} = 400V$ and $600V$
- $I_{GT} = 5mA$

DESCRIPTION

The Z006607xA triacs are intended for general applications where high gate sensitivity is required.

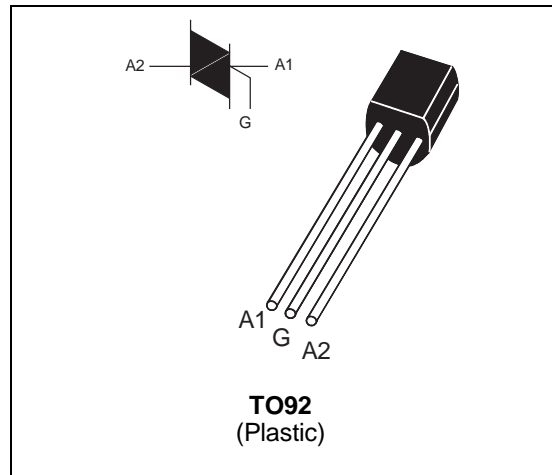

ABSOLUTE RATINGS (limiting values)

Symbol	Parameter		Value	Unit
$I_{T(RMS)}$	RMS on-state current (360° conduction angle)	$T_I = 50\text{ °C}$	0.8	A
I_{TSM}	Non repetitive surge peak on-state current (T_j initial = 25°C)	$t_p = 8.3\text{ ms}$	10.5	A
		$t_p = 10\text{ ms}$	10	
	Non repetitive surge peak on-state current (T_j initial = 110°C, full cycle)	$F = 60\text{ Hz}$	8	
I^2t	I^2t Value for fusing	$t_p = 10\text{ ms}$	0.5	A ² s
T_{stg} T_j	Storage and operating junction temperature range		- 40, + 150 - 40, + 110	°C
T_I	Maximum lead temperature for soldering during 10s		260	°C

Symbol	Parameter	Z00607xA		Unit
		D	M	
V_{DRM} V_{RRM}	Repetitive peak off-state voltage $T_j = 110\text{ °C}$	400	600	V

Z00607DA / Z00607MA

THERMAL RESISTANCES

Symbol	Parameter	Value	Unit
Rth(j-a)	Junction to ambient	150	°C/W
Rth(j-l)	Junction to lead	60	°C/W

GATE CHARACTERISTICS (maximum values)

$P_G (AV) = 0.1 \text{ W}$ $P_{GM} = 2 \text{ W}$ ($t_p = 20 \mu\text{s}$) $I_{GM} = 1 \text{ A}$ ($t_p = 20 \mu\text{s}$)

ELECTRICAL CHARACTERISTICS

Symbol	Test Conditions		Quadrant		Sensitivity		Unit
					07		
I_{GT}	$V_D = 12\text{V}$ (DC) $R_L = 140\Omega$	$T_j = 25^\circ\text{C}$	I-II-III	MAX	5		mA
			IV	MAX	7		
V_{GT}	$V_D = 12\text{V}$ (DC) $R_L = 140\Omega$	$T_j = 25^\circ\text{C}$	I-II-III-IV	MAX	1.5		V
V_{GD}	$V_D = V_{DRM}$ $R_L = 3.3\text{k}\Omega$	$T_j = 110^\circ\text{C}$	I-II-III-IV	MIN	0.2		V
tgt	$V_D = V_{DRM}$ $I_G = 25\text{mA}$ $I_T = 1.0\text{A}$ $dI_G/dt = 0.25\text{A}/\mu\text{s}$	$T_j = 25^\circ\text{C}$	I-II-III-IV	TYP	2		μs
I_H^*	$I_T = 200 \text{ mA}$ Gate open	$T_j = 25^\circ\text{C}$		MAX	5		mA
I_L	$I_G = 1.2 I_{GT}$	$T_j = 25^\circ\text{C}$	I-III-IV	MAX	10		mA
			II	MAX	20		
V_{TM}^*	$I_{TM} = 1.1\text{A}$ $t_p = 380\mu\text{s}$	$T_j = 25^\circ\text{C}$		MAX	1.5		V
I_{DRM} I_{RRM}	$V_D = V_{DRM}$ $V_R = V_{RRM}$	$T_j = 25^\circ\text{C}$		MAX	10		μA
		$T_j = 110^\circ\text{C}$		MAX	0.1		mA
dV/dt *	$V_D = 67\% V_{DRM}$ Gate open	$T_j = 110^\circ\text{C}$		MIN	10		V/ μs
(dV/dt)c *	(dI/dt)c = 0.35 A/ms	$T_j = 110^\circ\text{C}$		MIN	1.5		V/ μs

* For either polarity of electrode A2 voltage with reference to electrode A1

Fig 1: Maximum power dissipation versus RMS on-state current.

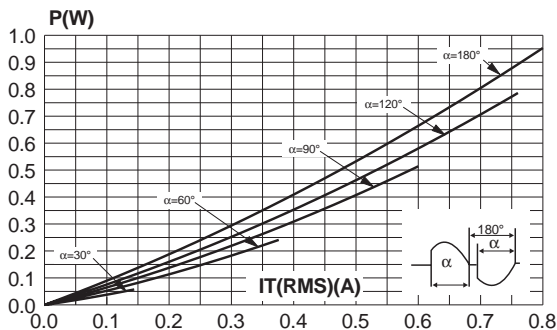

Fig 2: Correlation between maximum power dissipation and maximum allowable temperatures (T_{amb} and T_{lead}).

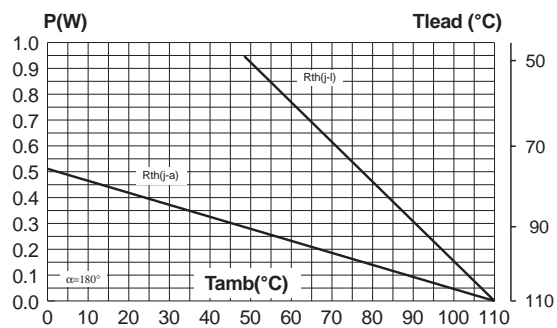

Fig 3: RMS on-state current versus ambient temperature.

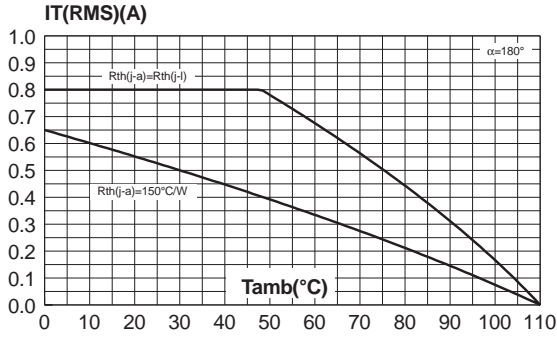

Fig 4: Relative variation of thermal impedance junction to ambient versus pulse duration.

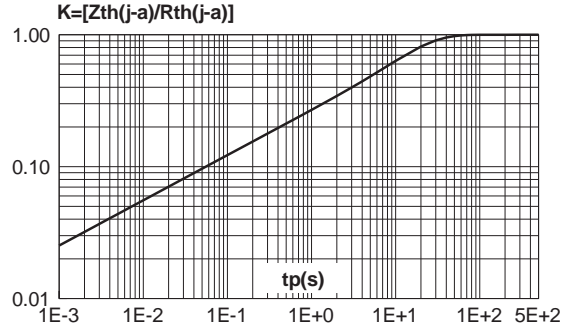

Fig 5: Relative variation of gate trigger current and holding current versus junction temperature (typical values).

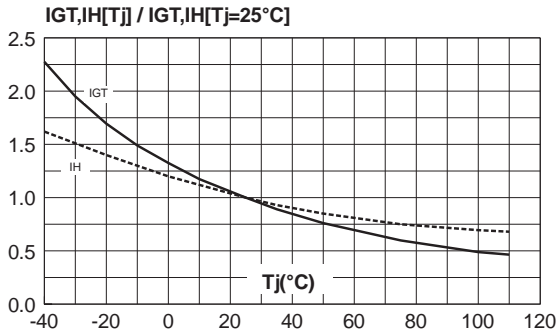

Fig 6: Non repetitive surge peak on-state current versus number of cycles.

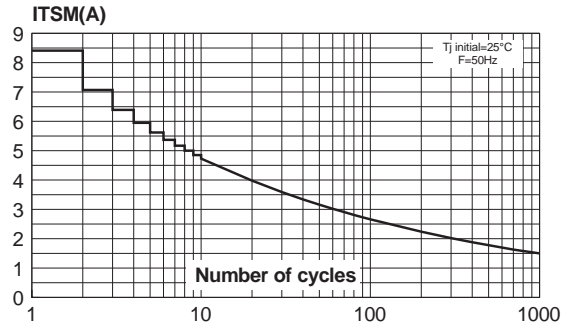

Fig 7: Non repetitive surge peak on-state current for a sinusoidal pulse with width $tp < 10\text{ms}$, and corresponding value of I^2t .

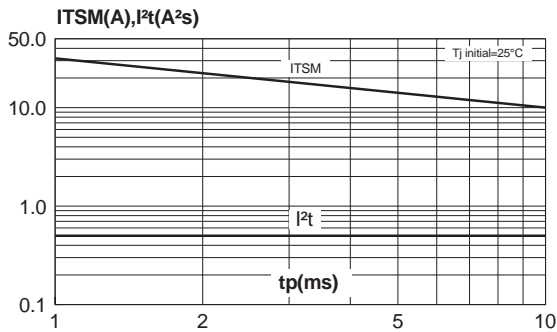
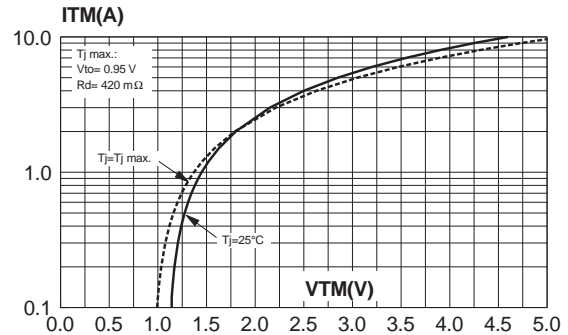

Fig 8: On-state characteristics (maximum values).



Z00607DA / Z00607MA

PACKAGE MECHANICAL DATA

TO92 (Plastic)

REF.	DIMENSIONS					
	Millimeters			Inches		
	Typ.	Min.	Max.	Typ.	Min.	Max.
A	1.35			0.053		
B			4.70			0.185
C	2.54			0.100		
D		4.40			0.173	
E		12.70			0.500	
F			3.70			0.146
a			0.45			0.017

Ordering type	Marking	Package	Weight	Base qty	Delivery mode
Z00607DA 1BA2	Z0607DA	TO92	0.2g.	2500	Bulk
Z00607MA 1BA2	Z0607MA	TO92	0.2g.	2500	Bulk

Information furnished is believed to be accurate and reliable. However, STMicroelectronics assumes no responsibility for the consequences of use of such information nor for any infringement of patents or other rights of third parties which may result from its use. No license is granted by implication or otherwise under any patent or patent rights of STMicroelectronics. Specifications mentioned in this publication are subject to change without notice. This publication supersedes and replaces all information previously supplied. STMicroelectronics products are not authorized for use as critical components in life support devices or systems without express written approval of STMicroelectronics.

The ST logo is a registered trademark of STMicroelectronics

© 1999 STMicroelectronics - Printed in Italy - All rights reserved.

STMicroelectronics GROUP OF COMPANIES

Australia - Brazil - Canada - China - France - Germany - Italy - Japan - Korea - Malaysia - Malta - Mexico - Morocco - The Netherlands - Singapore - Spain - Sweden - Switzerland - Taiwan - Thailand - United Kingdom - U.S.A.

<http://www.st.com>