

Low $V_{CE(sat)}$ PNP Epitaxial Planar Transistor

BTB1424AD3

Features

- Excellent DC current gain characteristics
- Low Saturation Voltage, $V_{CE(sat)} = -0.3V(\text{typ}) @ I_C = -2A, I_B = -100mA.$
- Complementary to BTD2150AD3
- Pb-free package

Symbol

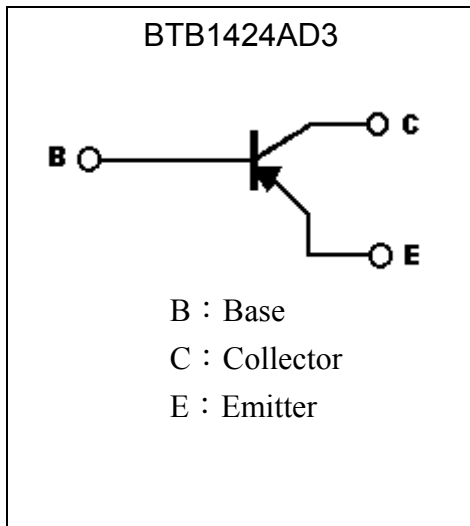

Outline

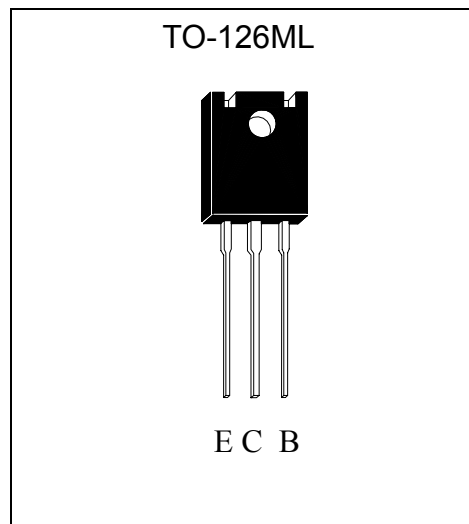

Absolute Maximum Ratings (Ta=25°C)

Parameter	Symbol	Limits	Unit
Collector-Base Voltage	V_{CBO}	-50	V
Collector-Emitter Voltage	V_{CEO}	-50	V
Emitter-Base Voltage	V_{EBO}	-6	V
Collector Current(DC)	I_C	-3	A
Collector Current(Pulsed) (Note 1)	I_{CP}	-5	
Power Dissipation(T _A =25°C)	P_d	1	W
Power Dissipation(T _C =25°C)		10	
Junction Temperature	T_j	150	°C
Storage Temperature	T_{stg}	-55~+150	°C

Note 1: Single pulse, $P_w \leq 10ms$, Duty Cycle $\leq 30\%$.

Characteristics (Ta=25°C)

Symbol	Min.	Typ.	Max.	Unit	Test Conditions
BV_{CBO}	-50	-	-	V	$I_C = -50\mu A$
BV_{CEO}	-50	-	-	V	$I_C = -1mA$
BV_{EBO}	-6	-	-	V	$I_E = -50\mu A$
I_{CBO}	-	-	-0.1	μA	$V_{CB} = -20V$
I_{EBO}	-	-	-0.1	μA	$V_{EB} = -5V$
* $V_{CE(sat)}$	-	-	-0.4	V	$I_C = -1A, I_B = -50mA$
* $V_{CE(sat)}$	-	-	-0.5	V	$I_C = -2A, I_B = -100mA$
* h_{FE}	82	-	560	-	$V_{CE} = -2V, I_C = -500mA$
f_T	-	240	-	MHz	$V_{CE} = -2V, I_C = -500mA, f = 100MHz$
Cob	-	35	-	pF	$V_{CB} = -10V, f = 1MHz$

*Pulse Test: Pulse Width $\leq 380\mu s$, Duty Cycle $\leq 2\%$

Classification Of h_{FE}

Rank	P	Q	R	S
h_{FE} range	82~180	120~270	180~390	270~560

Characteristic Curves

Current Gain vs Collector Current

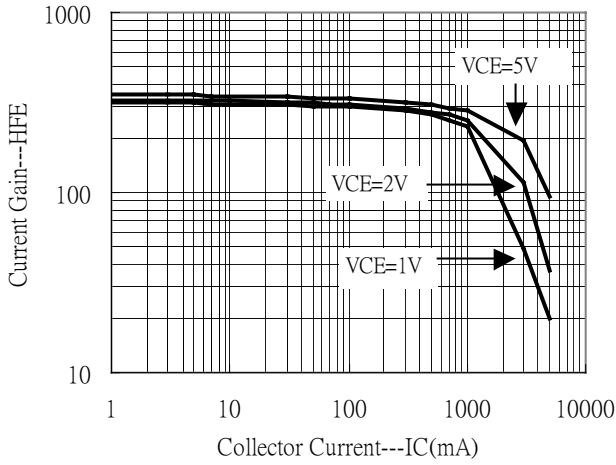

Saturation Voltage vs Collector Current

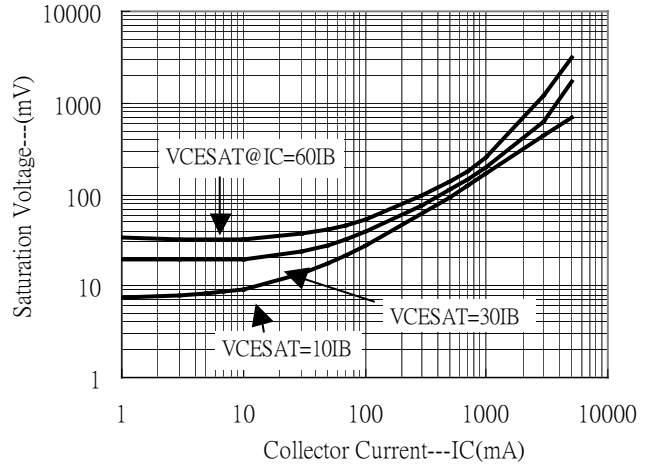

Saturation Voltage vs Collector Current

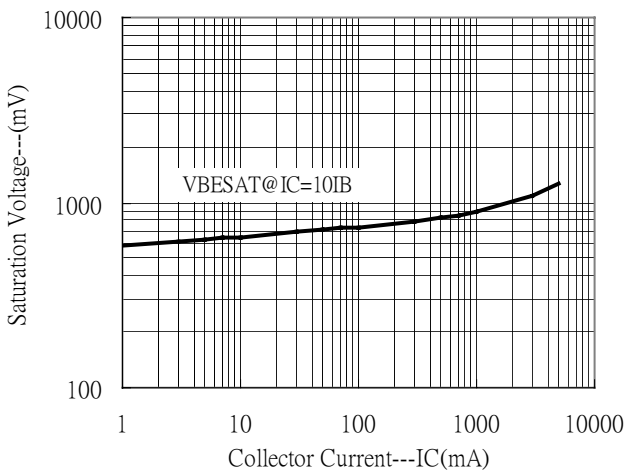

Power Derating Curve

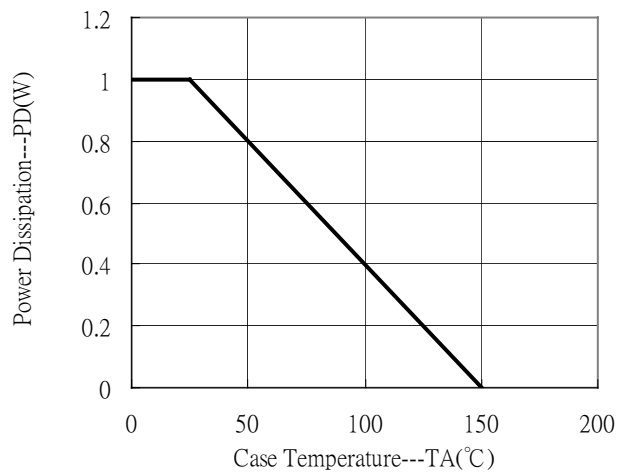

Power Derating Curve

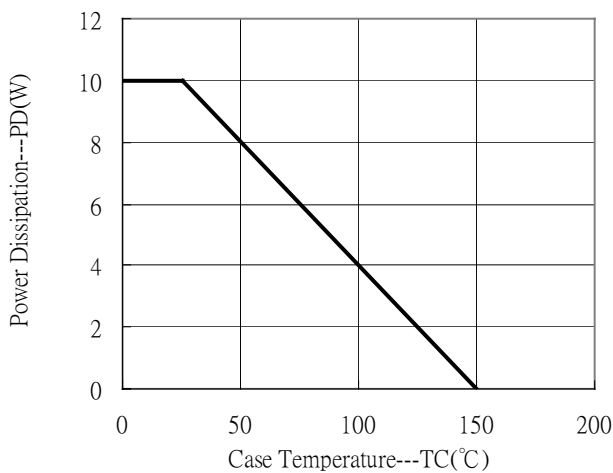

TO-126ML Dimension

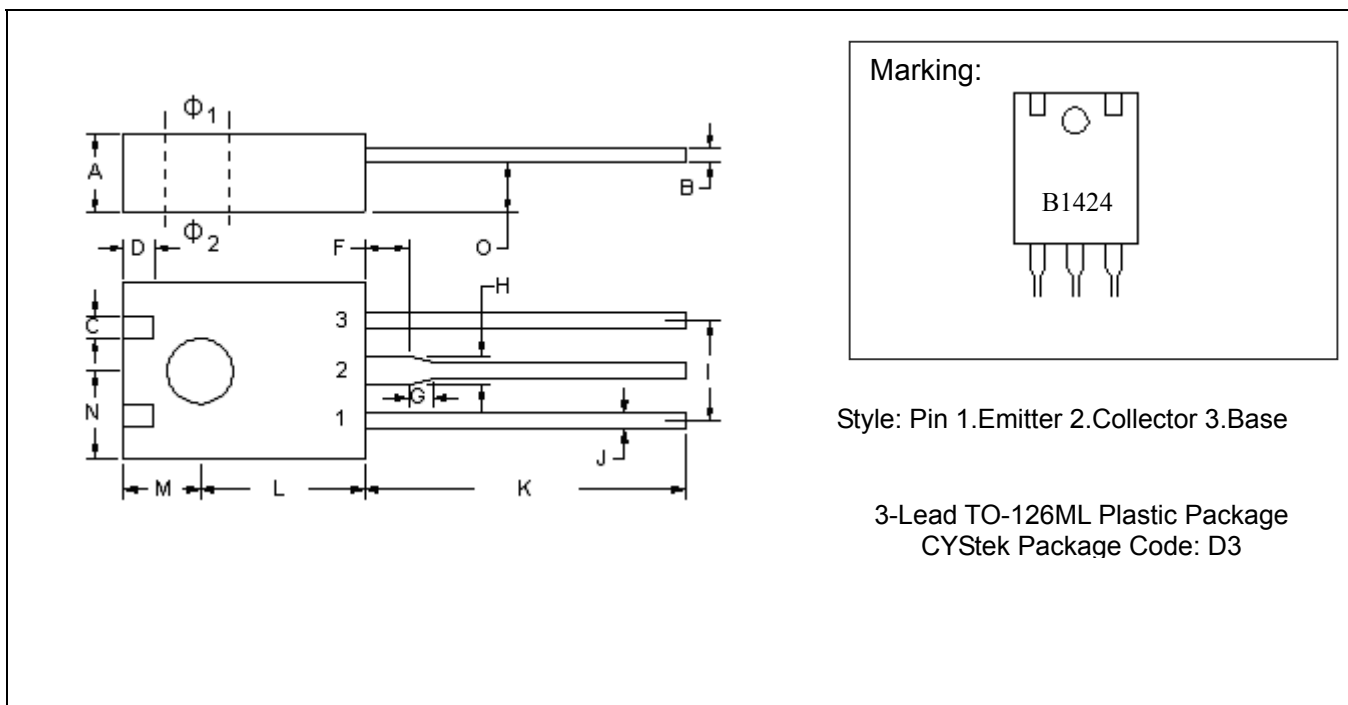

*: Typical

DIM	Inches		Millimeters		DIM	Inches		Millimeters	
	Min.	Max.	Min.	Max.		Min.	Max.	Min.	Max.
A	0.1356	0.1457	3.44	3.70	H	0.0462	0.0562	1.17	1.42
B	0.0170	0.0272	0.43	0.69	I	-	*0.1795	-	*4.56
C	0.0344	0.0444	0.87	1.12	J	0.0268	0.0331	0.68	0.84
D	0.0501	0.0601	1.27	1.52	K	0.5512	0.5906	14.00	15.00
Φ ₁	0.1220	0.1299	3.10	3.30	L	0.2903	0.3003	7.37	7.62
Φ ₂	0.1181	0.1260	3.00	3.20	M	0.1378	0.1478	3.50	3.75
F	0.0737	0.0837	1.87	2.12	N	0.1525	0.1625	3.87	4.12
G	0.0294	0.0494	0.74	1.25	O	0.0740	0.0842	1.88	2.14

Notes: 1. Controlling dimension: millimeters.
 2. Maximum lead thickness includes lead finish thickness, and minimum lead thickness is the minimum thickness of base material.
 3. If there is any question with packing specification or packing method, please contact your local CYStek sales office.

Material:

- Lead: 42 Alloy ; solder plating
- Mold Compound: Epoxy resin family, flammability solid burning class: UL94V-0

Important Notice:

- All rights are reserved. Reproduction in whole or in part is prohibited without the prior written approval of CYStek.
- CYStek reserves the right to make changes to its products without notice.
- CYStek **semiconductor products are not warranted to be suitable for use in Life-Support Applications, or systems.**
- CYStek assumes no liability for any consequence of customer product design, infringement of patents, or application assistance.