

N Channel Enhancement Mode MOSFET ST2304

2.5A

DESCRIPTION

The ST2304 is the N-Channel logic enhancement mode power field effect transistor are produced using high cell density, DMOS trench technology.

This high density process is especially tailored to minimize on-state resistance.

These devices are particularly suited for low voltage application such as cellular phone and notebook computer power management and other batter powered circuits, and low in-line power loss are needed in a very small outline surface mount package.

PIN CONFIGURATION SOT-23-3L

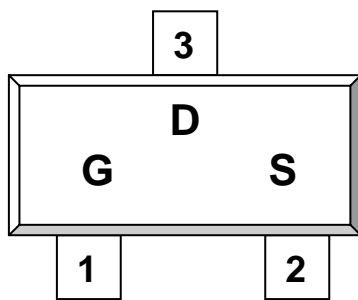

1.Gate 2.Source 3.Drain

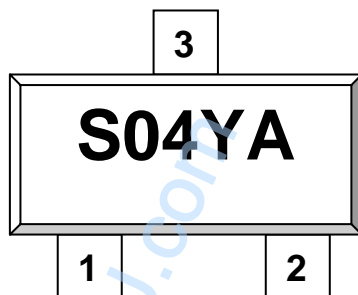

S: Subcontractor Y: Year Code W: Process Code

FEATURE

- 30V/2.5A, $R_{DS(ON)} = 70\text{m-ohm}$
@VGS = 10V
- 30V/2.0A, $R_{DS(ON)} = 105\text{m-ohm}$
@VGS = 4.5V
- Super high density cell design for extremely low $R_{DS(ON)}$
- Exceptional on-resistance and maximum DC current capability
- SOT-23-3L package design



STANSON TECHNOLOGY

120 Bentley Square, Mountain View, Ca 94040 USA

TEL: (650) 9389294 FAX: (650) 9389295

N Channel Enhancement Mode MOSFET ST2304

2.5A

ABSOLUTE MAXIMUM RATINGS (Ta = 25 Unless otherwise noted)

Parameter	Symbol	Typical	Unit
Drain-Source Voltage	V _{DSS}	30	V
Gate-Source Voltage	V _{GSS}	20	V
Continuous Drain Current (T _J =150)	I _D	T _A =25	A
		T _A =70	2.0
Pulsed Drain Current	I _{DM}	10	A
Continuous Source Current (Diode Conduction)	I _S	1.25	A
Power Dissipation	P _D	T _A =25	W
		T _A =70	0.8
Operation Junction Temperature	T _J	150	
Storage Temperature Range	T _{STG}	-55/150	
Thermal Resistance-Junction to Ambient	R _{JA}	100	/W



STANSON TECHNOLOGY

120 Bentley Square, Mountain View, Ca 94040 USA

TEL: (650) 9389294 FAX: (650) 9389295

N Channel Enhancement Mode MOSFET ST2304

2.5A

ELECTRICAL CHARACTERISTICS ($T_a = 25$ Unless otherwise noted)

Parameter	Symbol	Condition	Min	Typ	Max	Unit
Static						
Drain-Source Breakdown Voltage	$V_{(BR)DSS}$	$V_{GS}=0V, I_D=250\mu A$	30			V
Gate Threshold Voltage	$V_{GS(th)}$	$V_{DS}=V_{GS}, I_D=250\mu A$	1.0		3.0	V
Gate Leakage Current	I_{GSS}	$V_{DS}=0V, V_{GS}=20V$			100	nA
Zero Gate Voltage Drain Current	I_{DSS}	$V_{DS}=30V, V_{GS}=1.0V$			1	uA
		$V_{DS}=30V, V_{GS}=0V$ $T_J=55$			10	
On-State Drain Current	$I_{D(on)}$	$V_{DS} = 4.5V, V_{GS}=10V$ $V_{DS} = 4.5V, V_{GS}=4.5V$	6 4			A
Drain-source On-Resistance	$R_{DS(on)}$	$V_{GS}=10V, I_D=2.5A$ $V_{GS}=4.5V, I_D=2.0A$		0.055 0.08	0.07 0.105	
Forward Transconductance	g_{fs}	$V_{DS}=4.5V, I_D=2.5V$		4.6		S
Diode Forward Voltage	V_{SD}	$I_S=-1.25A, V_{GS}=0V$		0.77	1.2	V
Dynamic						
Total Gate Charge	Q_g	$V_{DS}=15V, V_{GS}=4.5V$ $I_D = 2.5A$		4.5	10	nC
Gate-Source Charge	Q_{gs}			0.8		
Gate-Drain Charge	Q_{gd}			1.0		
Input Capacitance	C_{iss}	$V_{DS}=10V, V_{GS}=0V$ $F=1MHz$		240		pF
Output Capacitance	C_{oss}			110		
Reverse Transfer Capacitance	C_{rss}			17		
Turn-On Time	$t_{d(on)}$	$V_{DD}=15V, R_L=15$ $I_D=1.0A, V_{GEN}=10V$ $R_G=6$		8	20	nS
	t_r			12	30	
Turn-Off Time	$t_{d(off)}$			17	35	
	t_f			8	20	



STANSON TECHNOLOGY

120 Bentley Square, Mountain View, Ca 94040 USA

TEL: (650) 9389294 FAX: (650) 9389295

N Channel Enhancement Mode MOSFET ST2304

2.5A

SOT-23-3L PACKAGE OUTLINE

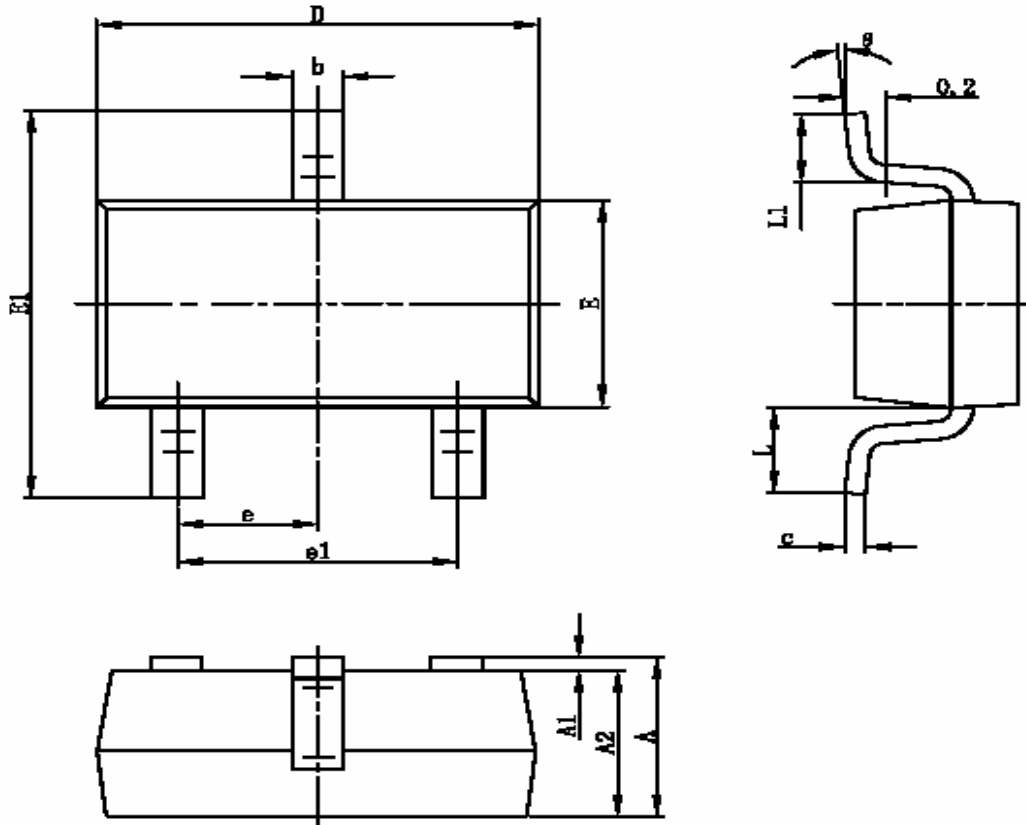

Symbol	Dimensions In Millimeters		Dimensions In Inches	
	Min	Max	Min	Max
A	1.050	1.250	0.041	0.049
A1	0.000	0.100	0.000	0.004
A2	1.050	1.150	0.041	0.045
b	0.300	0.400	0.012	0.016
c	0.100	0.200	0.004	0.008
D	2.820	3.020	0.111	0.119
E	1.500	1.700	0.059	0.067
E1	2.650	2.950	0.104	0.116
e	0.950TYP		0.037TYP	
e1	1.800	2.000	0.071	0.079
L	0.700REF		0.028REF	
L1	0.300	0.600	0.012	0.024
θ	0°	8°	0°	8°



STANSON TECHNOLOGY

120 Bentley Square, Mountain View, Ca 94040 USA
 TEL: (650) 9389294 FAX: (650) 9389295

N Channel Enhancement Mode MOSFET ST2304

2.5A

TYPICAL CHARACTERISTICS (25°C Unless noted)

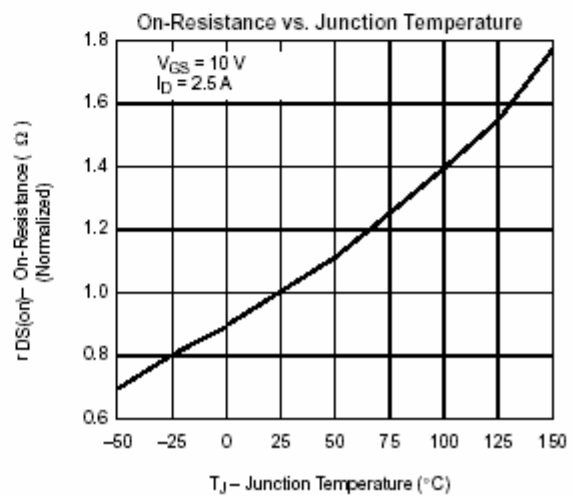
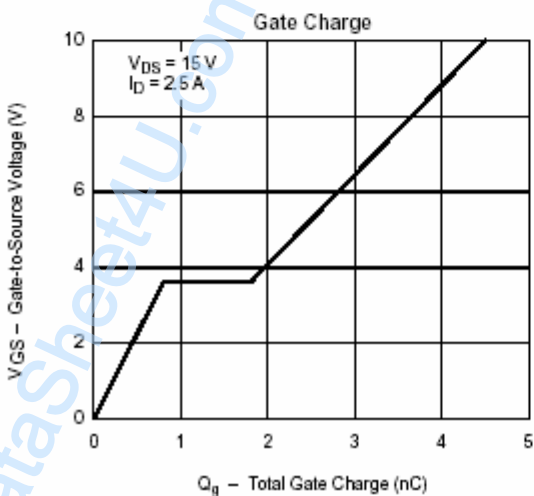
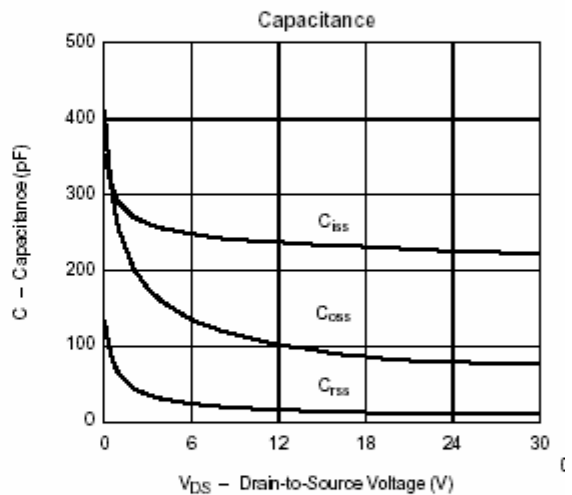
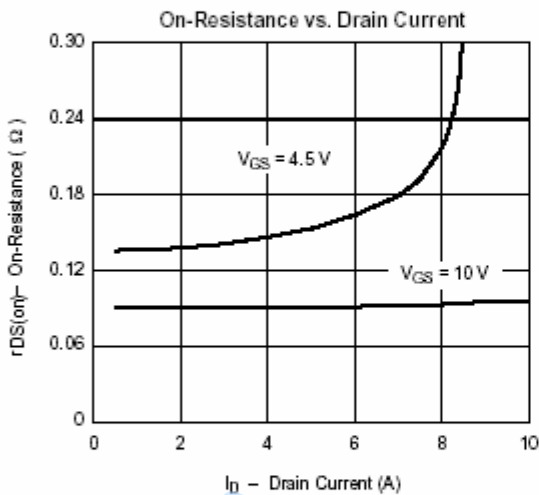
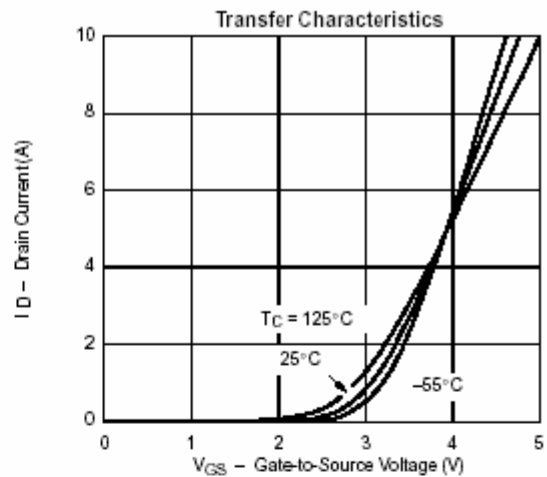
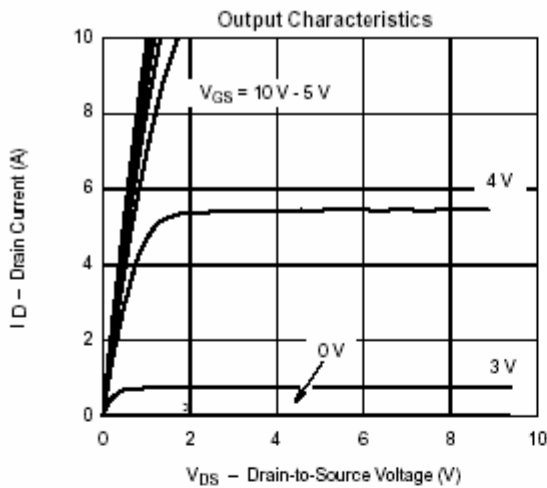

N Channel Enhancement Mode MOSFET ST2304

2.5A

TYPICAL CHARACTERISTICS (25 Unless noted)

