

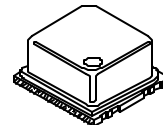

# ST2200 SERIES

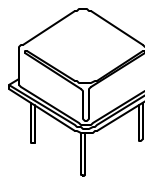

- TRUE TTL OUTPUT
- LOWER EMI DUE TO LOWER RINGING NOISE (OVERSHOOT/ UNDERSHOOT)
- 8-PIN (HALF SIZE) THRU-HOLE OSCILLATORS IN METAL PACKAGE
- AVAILABLE IN SURFACE MOUNT CONFIGURATION

## STANDARD SPECIFICATIONS:

Frequency Range	4.000 – 60.000 MHz (Consult factory for specific available frequencies)
Frequency Stability over Operating Temperature Range	± 50 PPM is standard, but ± 25 PPM is also available.
Operating Temperature Range	0 - 70 °C is standard, but can be extended to -40 to +85°C.
Input Voltage (Vcc)	5 Volt ± 10%
Symmetry (Duty Cycle) (See next page for definition.)	40/60 - 60/40% is standard, but 45/55% symmetry at Vcc=1.4V is also available.
Input Current (Icc) & Rise and Fall Time (Tr & Tf) between 0.4V and 2.4V	Depends on frequency and output load. See next page.
Logic "1" & Logic "0" (See next page.)	2.4V MIN.; 0.4V MAX.
Output Load	Up to 10 TTL loads +15 pF
Ringling Noise	Depends on frequency and output load. See EMI application note.
Packaging	33 parts per tube, SMD: Tape and Reel TBD

## PART NUMBERING GUIDE:

- The Pletronics part number for an ST2200 series oscillator consists of the following 4 elements:

**1. Overall Frequency Stability over Operating Temperature Range:**

ST2245: ± 50 PPM;

ST2244: ± 25 PPM

**2. Optional Alphabet Designator for Special Requirement:**

ST2245: standard specifications;

ST2245E: operating temperature range of -40 to +85°C;

ST2245P: 45/55% symmetry at Vcc=1.4V;

(There are other alphabet designators not listed here.)

**3. Frequency of Operation in MHz**

**4. Optional Surface Mount Configuration – SMD**

EXAMPLES: ST2245E-10.000 MHz; ST2245P-10.000 MHz, ST2244-10.000 MHz-SMD

- When customer's requirements are non-standard, a special engineering part number will be assigned.

(continued)

# ST2200 SERIES

## Input Current (I<sub>cc</sub>), Rise and Fall time with 15pF Load & Jitter

Frequency Range (MHz)	I <sub>cc</sub> (mA)		Tr & Tf (nS)		Period Jitter RMS Values *contact factory	
	Typical	Maximum	Typical	Maximum	Typical	Maximum
4.000 – 7.999	23.0	28.0	4.0	5.0	*	*
8.000 – 15.999	24.0	28.0	3.0	4.0	*	*
16.000 – 21.999	24.0	28.0	2.5	3.5	*	*
22.000 – 60.000	27.0	32.0	20.	3.0	*	*

### Recommended Test Circuit with TTL Load

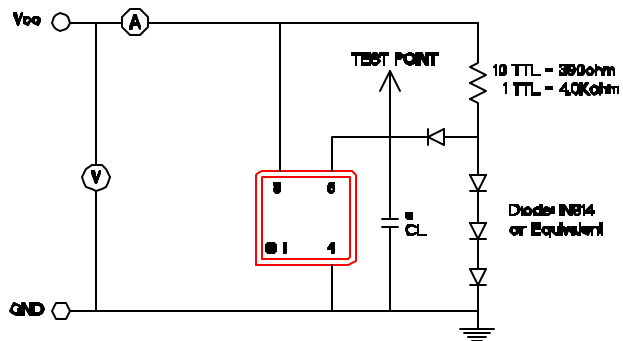

### Waveform

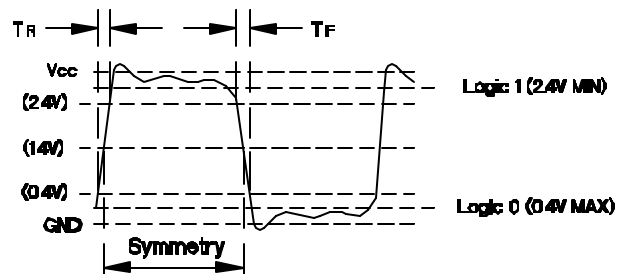

\*CL (Capacitive Load): Includes the input capacitance of oscilloscope.

### Thru-Hole Package Outlines (NOT TO SCALE):

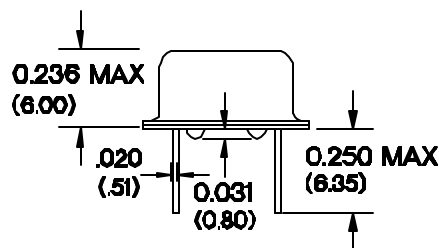
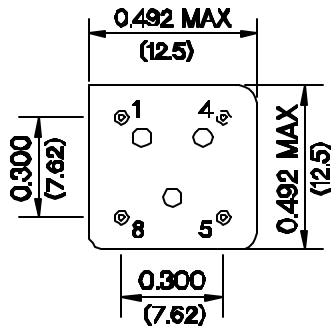

INCHES (MILLIMETERS)

PIN CONNECTIONS	
PIN	CONNECTION
1	NO CONNECTION
4	GROUND
5	OUTPUT
8	V <sub>cc</sub>

### Recommended Land Pattern

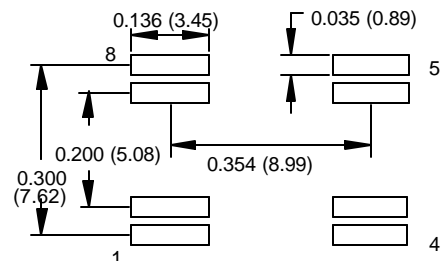
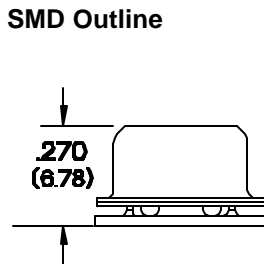
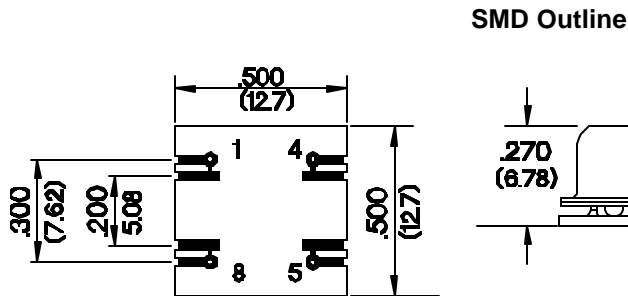

October 2000