

# T143-500



## Phase Control Thyristor



Type	$V_{RSM}$ , $V_{DSM}$	$V_{RRM}$ , $V_{DRM}$
T143-500-4	500	400
T143-500-6	700	600
T143-500-8	900	800
T143-500-10	1100	1000
T143-500-12	1300	1200
T143-500-14	1500	1400
T143-500-16	1700	1600

www.DataSheet4U.com

Symbol	Parameter	Test Conditions	Value	Unit
$I_{TAVM}$	average on-state current	$T_C=75^\circ\text{C}$	500	A
$I_{TRMS}$	maximum RMS on-state current	$T_J=T_{JM}$	1160	A
$I_{TSM}$	surge-current	$T_C=25^\circ\text{C}; t_p=10\text{ms}$	12.0	kA
		$T_J=T_{JM}; t_p=10\text{ms}$	10.8	
$i^2t$	$i^2t$ -value	$T_C=25^\circ\text{C}; t_p=10\text{ms}$	720	$\text{kA}^2\cdot\text{s}$
		$T_J=T_{JM}; t_p=10\text{ms}$	605	
$(di/dt)_{cr}$	critical rate of rise of on-state current	$T_J=T_{JM}; V_D=0.67\cdot V_{DRM};$ $f=50\text{ Hz}; I_{GM}=1\text{A};$ $di_G/dt=1\text{A}/\mu\text{s}$	100	$\text{A}/\mu\text{s}$
$(dv/dt)_{cr}$	critical rate of rise of off-state voltage	$T_J=T_{JM}; V_D=0.67\cdot V_{DRM};$ gate open	1000	$\text{V}/\mu\text{s}$
$I_{RRM}/I_{DRM}$	off-state Leakage current	$T_J=T_{JM}; V_R=V_{RRM}; V_D=V_{DRM}$	30	mA
$V_{RRM}$	reverse repeat peak value voltage	$T_J=T_{JM}; 180^\circ\text{C sine wave},$ 50 Hz; gate open	300-2400	V
$V_{DRM}$	off state repeat peak value voltage		300-2400	V
$V_{RSM}$	non-repetitive peak reverse voltage	$T_J=T_{JM}$	400-2500	V
$V_{TM}$	on-state voltage	$T_J=T_{JM}; I_{TM}=1500\text{A}$	1.80	V
$r_T$	slope resistance	$T_J=T_{JM}$	0.57	m
$V_{GT}$	gate trigger voltage	$T_J=25^\circ\text{C}; V_D=12\text{V}$	3.50	V
$I_{GT}$	gate trigger current	$T_J=25^\circ\text{C}; V_D=12\text{V}$	0.25	A
$V_{GD}$	gate non-trigger voltage	$T_J=T_{JM}; V_D=0.67\cdot V_{DRM}$	0.50	V
$I_{GD}$	gate non-trigger current	$T_J=T_{JM}; V_D=0.67\cdot V_{DRM}$	10.0	mA
$I_H$	holding current	$T_J=25^\circ\text{C}; V_D=12\text{V};$ gate open	300	mA
$I_L$	latching current	$T_J=25^\circ\text{C}; V_D=12\text{V};$ $t_G=20\mu\text{s}; I_{GM}=1\text{A};$ $di_G/dt=1\text{A}/\mu\text{s}$	700	mA

$t_{gd}$	delay time	$T_J=25^{\circ}\text{C}; V_D=0.5 \cdot V_{DRM};$ $I_{GM}=1\text{A}; di_G/dt=1\text{A}/\mu\text{s}$	7	$\mu\text{s}$
$t_q$	turn-off time	$T_J=T_{JM}; I_T=I_{TAVM};$ $di_R/dt=5\text{A}/\mu\text{s};$ $V_D=0.67 \cdot V_{DRM}; V_R=100\text{V};$ $dV_D/dt=50\text{V}/\mu\text{s}$	250	$\mu\text{s}$
$V_{TO}$	threshold voltage	$T_J=T_{JM}$	1.10	V
$T_J$	working junction temperature		-60...+125	$^{\circ}\text{C}$
$T_{JM}$	maximum working junction temperature		125	$^{\circ}\text{C}$
$T_{stg}$	storage temperature		-60...+50	$^{\circ}\text{C}$
$R_{thJC}$	thermal resistance; junction to case	DC, two-sided cooling	0.034	$^{\circ}\text{C}/\text{W}$
$F$	clamping force		14...17	kN
$W$	weight		260	g
$a$	maximum allowable acceleration		50	$\text{m/s}^2$

www.DataSheet4U.com

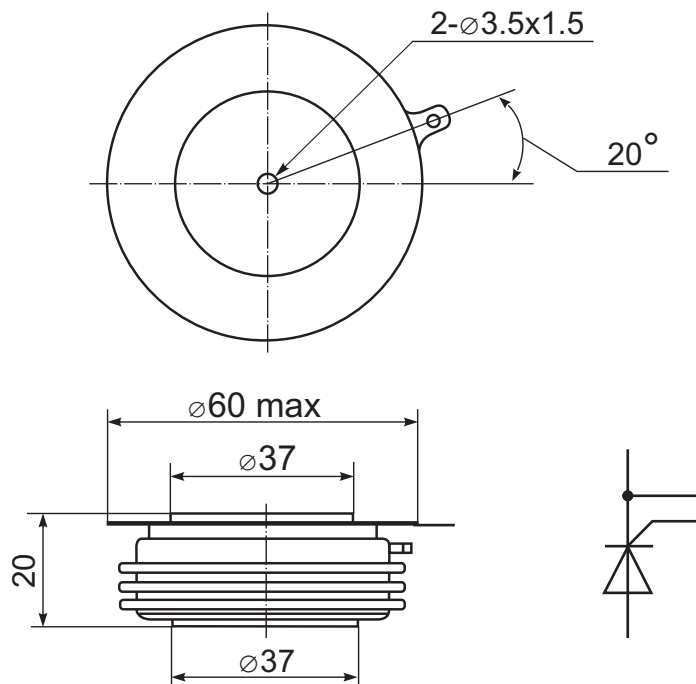

#### Features:

- Hermetic metal case with ceramic insulator
- Capsule packages for double sided cooling
- International standard case
- Amplifying gates

#### Typical Applications:

- DC motor control
- AC motor soft starter
- Controlled rectifiers
- AC controllers

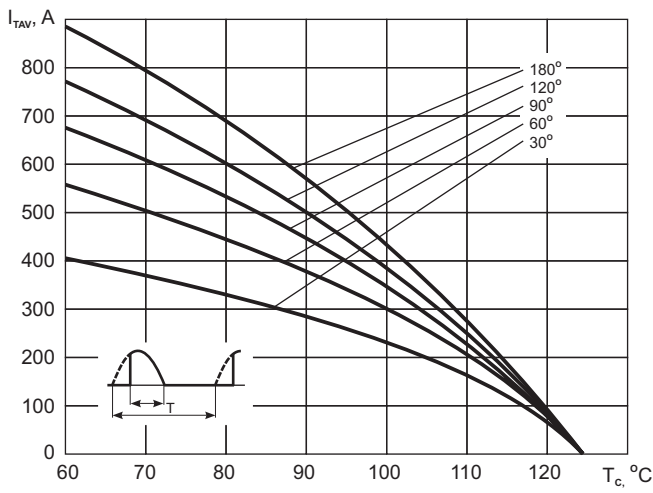

Max. case temperature vs. average on-state current, sine waveform,  $f=50\text{Hz}$ ,  $T=1/f$

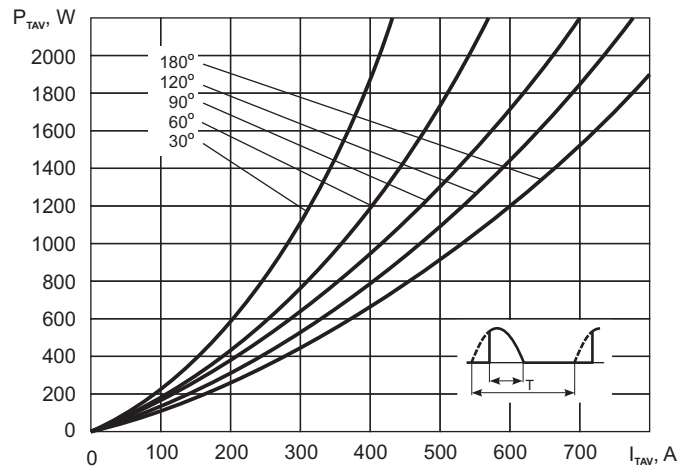

On-state power loss vs. average on-state current, sine waveform,  $f=50\text{Hz}$ ,  $T=1/f$

www.DataSheet4U.com

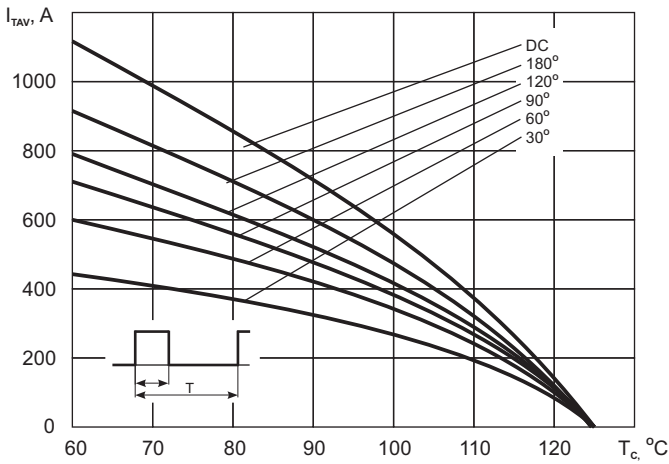

Max. case temperature vs. average on-state current, square waveform,  $f=50\text{Hz}$ ,  $T=1/f$

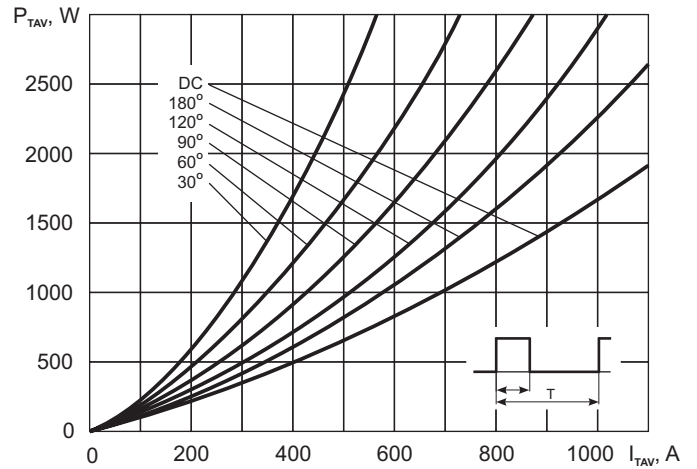

On-state power loss vs. average on-state current, square waveform,  $f=50\text{Hz}$ ,  $T=1/f$

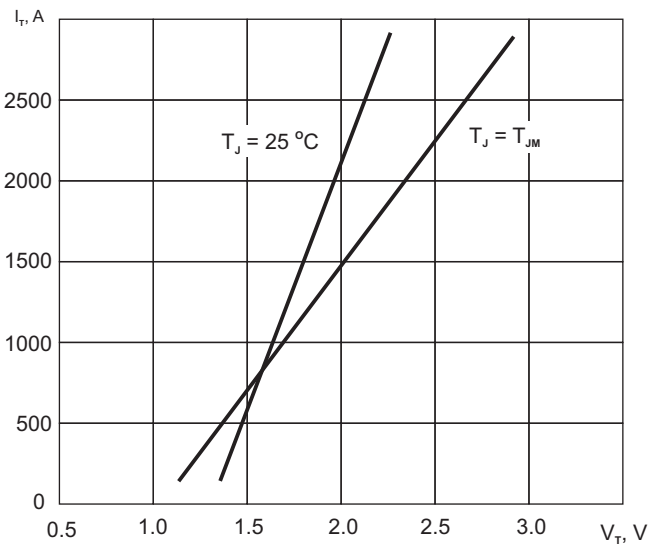

Limiting on-state characteristic  $I_T = f(V_T)$

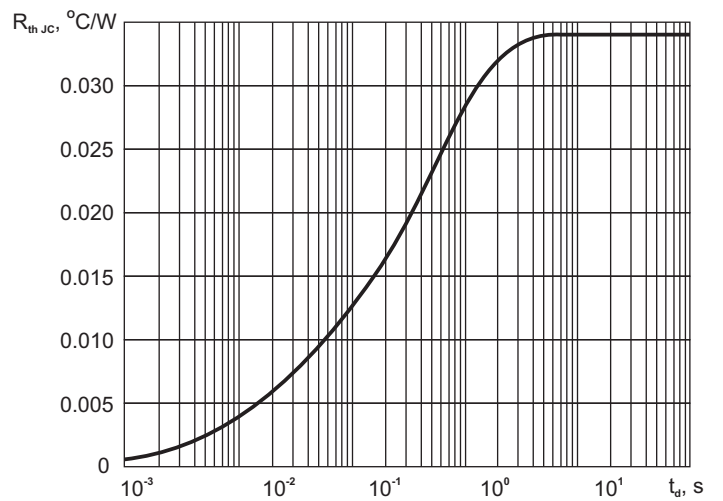

Transient thermal impedance  $R_{thJC} = f(t_d)$   
 $t_d$  - square wave pulse duration