

IGBT Power Module

Preliminary data

- 600V NPT Technology
- Solderable Power module
- 3-phase full-bridge
- Including fast free-wheel diodes
- Package with insulated metal base plate

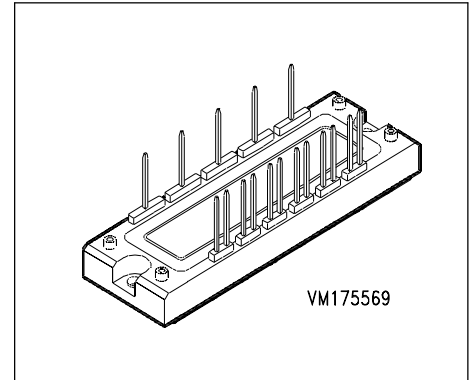

Type	V_{CE}	I_C	Package	Ordering Code
BSM 20 GD 60 DL	600V	25A	ECONOPACK 2	Q67050-A0003-A67

Maximum Ratings

Parameter	Symbol	Values	Unit
Collector-emitter voltage	V_{CE}	600	V
Collector-gate voltage	V_{CGR}	600	
$R_{GE} = 20 \text{ k}\Omega$			
Gate-emitter voltage	V_{GE}	± 20	
DC collector current	I_C	25	A
$T_C = 25 \text{ }^\circ\text{C}$			
$T_C = 60 \text{ }^\circ\text{C}$		20	
Pulsed collector current, $t_p = 1 \text{ ms}$	I_{Cpuls}	50	
$T_C = 25 \text{ }^\circ\text{C}$			
$T_C = 60 \text{ }^\circ\text{C}$		40	
Power dissipation per IGBT	P_{tot}	80	W
$T_C = 25 \text{ }^\circ\text{C}$			
Chip temperature	T_j	+ 150	$^\circ\text{C}$
Storage temperature	T_{stg}	-40 ... + 125	
Thermal resistance, chip case	R_{thJC}	≤ 1.6	K/W
Diode thermal resistance, chip case	R_{thJCD}	≤ 1.8	
Insulation test voltage, $t = 1 \text{ min.}$	V_{is}	2500	Vac
Creepage distance	-	16	mm
Clearance	-	11	
DIN humidity category, DIN 40 040	-	F	sec
IEC climatic category, DIN IEC 68-1	-	40 / 125 / 56	

Electrical Characteristics, at $T_j = 25\text{ °C}$, unless otherwise specified

Parameter	Symbol	Values			Unit
		min.	typ.	max.	

Static Characteristics

Gate threshold voltage $V_{GE} = V_{CE}, I_C = 0.5\text{ mA}$	$V_{GE(th)}$	4.5	5.5	6.5	V
Collector-emitter saturation voltage $V_{GE} = 15\text{ V}, I_C = 20\text{ A}, T_j = 25\text{ °C}$ $V_{GE} = 15\text{ V}, I_C = 20\text{ A}, T_j = 125\text{ °C}$	$V_{CE(sat)}$	-	2.1 2.4	2.5 2.8	
Zero gate voltage collector current $V_{CE} = 600\text{ V}, V_{GE} = 0\text{ V}, T_j = 25\text{ °C}$	I_{CES}	-	-	1	mA
Gate-emitter leakage current $V_{GE} = 25\text{ V}, V_{CE} = 0\text{ V}$	I_{GES}	-	-	100	nA

AC Characteristics

Transconductance $V_{CE} = 20\text{ V}, I_C = 20\text{ A}$	g_{fs}	5.5	-	-	S
Input capacitance $V_{CE} = 25\text{ V}, V_{GE} = 0\text{ V}, f = 1\text{ MHz}$	C_{iss}	-	1100	-	pF
Output capacitance $V_{CE} = 25\text{ V}, V_{GE} = 0\text{ V}, f = 1\text{ MHz}$	C_{oss}	-	120	-	
Reverse transfer capacitance $V_{CE} = 25\text{ V}, V_{GE} = 0\text{ V}, f = 1\text{ MHz}$	C_{rss}	-	72	-	

Electrical Characteristics, at $T_j = 25\text{ °C}$, unless otherwise specified

Parameter	Symbol	Values			Unit
		min.	typ.	max.	

Switching Characteristics, Inductive Load at $T_j = 125\text{ °C}$

Turn-on delay time $V_{CC} = 300\text{ V}$, $V_{GE} = 15\text{ V}$, $I_C = 20\text{ A}$ $R_{Gon} = 47\ \Omega$	$t_{d(on)}$	-	30	-	ns
Rise time $V_{CC} = 300\text{ V}$, $V_{GE} = 15\text{ V}$, $I_C = 20\text{ A}$ $R_{Gon} = 47\ \Omega$	t_r	-	35	-	
Turn-off delay time $V_{CC} = 300\text{ V}$, $V_{GE} = -15\text{ V}$, $I_C = 20\text{ A}$ $R_{Goff} = 47\ \Omega$	$t_{d(off)}$	-	200	-	
Fall time $V_{CC} = 300\text{ V}$, $V_{GE} = -15\text{ V}$, $I_C = 20\text{ A}$ $R_{Goff} = 47\ \Omega$	t_f	-	30	-	

Free-Wheel Diode

Diode forward voltage $I_F = 20\text{ A}$, $V_{GE} = 0\text{ V}$, $T_j = 25\text{ °C}$ $I_F = 20\text{ A}$, $V_{GE} = 0\text{ V}$, $T_j = 125\text{ °C}$	V_F	-	2 1.8	-	V
Reverse recovery time $I_F = 20\text{ A}$, $V_R = -300\text{ V}$, $V_{GE} = 0\text{ V}$ $di_F/dt = -600\text{ A}/\mu\text{s}$, $T_j = 125\text{ °C}$	t_{rr}	-	0.3	-	
Reverse recovery charge $I_F = 20\text{ A}$, $V_R = -300\text{ V}$, $V_{GE} = 0\text{ V}$ $di_F/dt = -600\text{ A}/\mu\text{s}$ $T_j = 25\text{ °C}$ $T_j = 125\text{ °C}$	Q_{rr}	-	0.6 1.7	-	μC
		-		-	

Power dissipation

$P_{tot} = f(T_C)$

parameter: $T_j \leq 150\text{ }^\circ\text{C}$

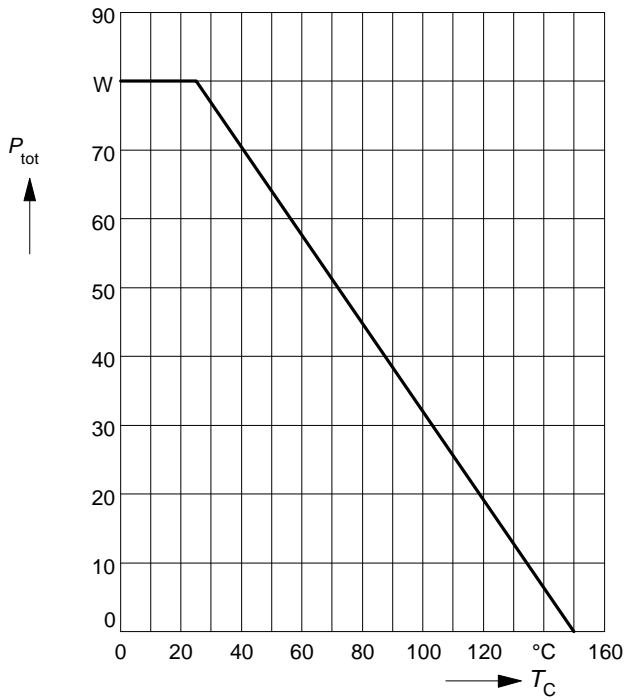

Safe operating area

$I_C = f(V_{CE})$

parameter: $D = 0, T_C = 25\text{ }^\circ\text{C}, T_j \leq 150\text{ }^\circ\text{C}$

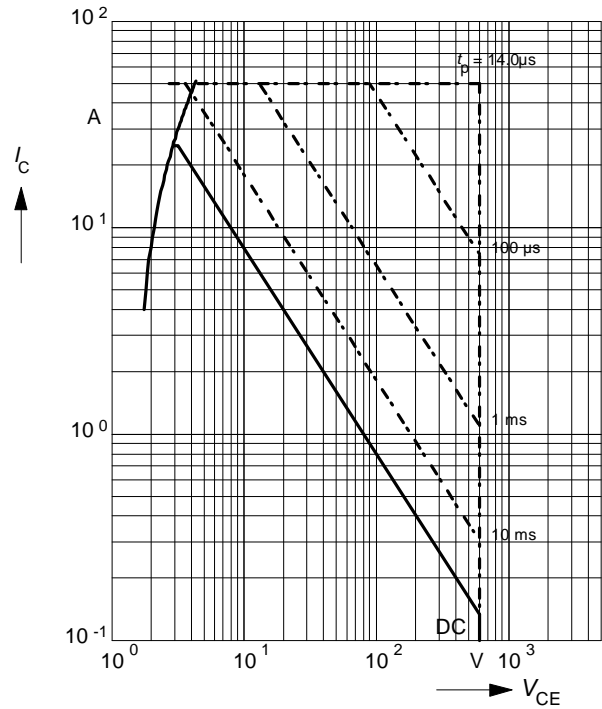

Collector current

$I_C = f(T_C)$

parameter: $V_{GE} \geq 15\text{ V}, T_j \leq 150\text{ }^\circ\text{C}$

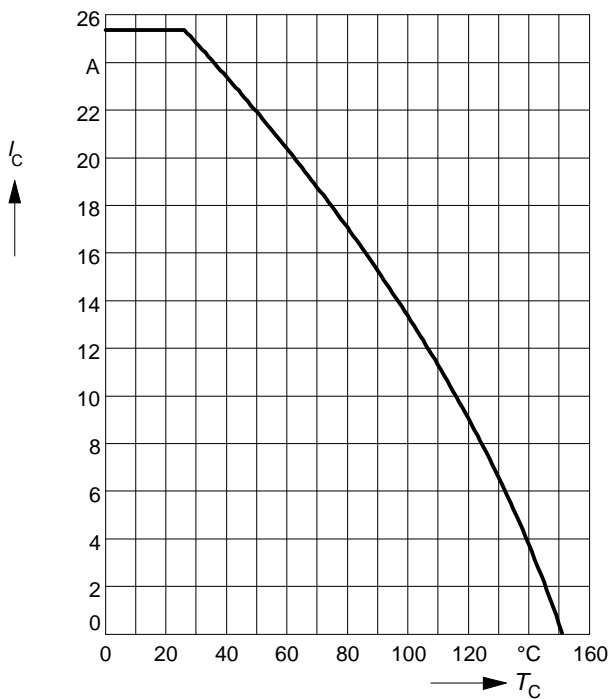

Transient thermal impedance IGBT

$Z_{thJC} = f(t_p)$

parameter: $D = t_p / T$

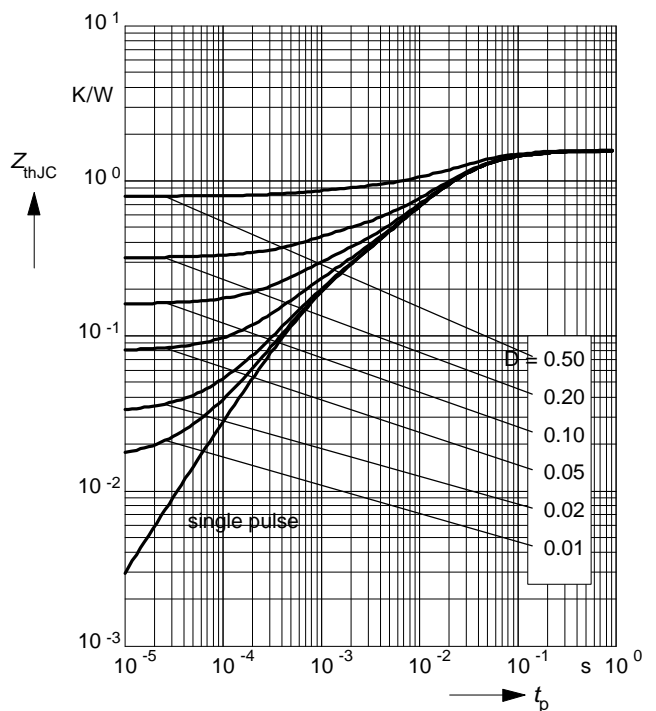

Typ. output characteristics

$I_C = f(V_{CE})$

parameter: $t_p = 250 \mu s, T_j = 25 \text{ }^\circ\text{C}$

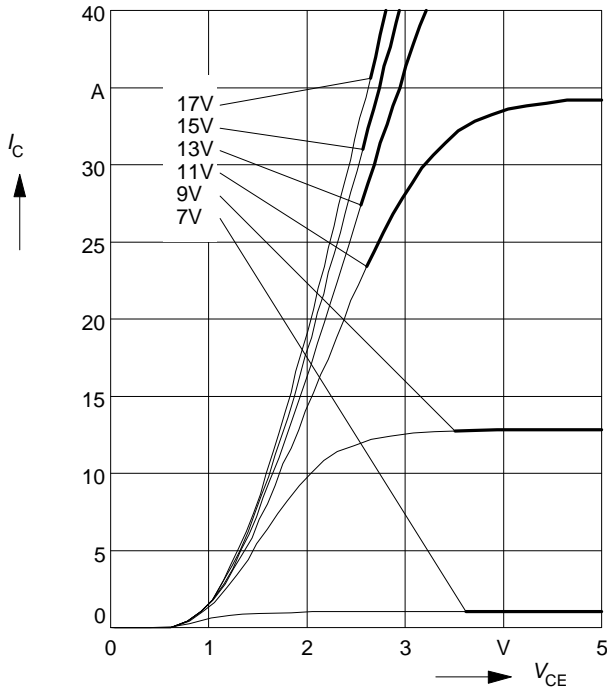

Typ. output characteristics

$I_C = f(V_{CE})$

parameter: $t_p = 250 \mu s, T_j = 125 \text{ }^\circ\text{C}$

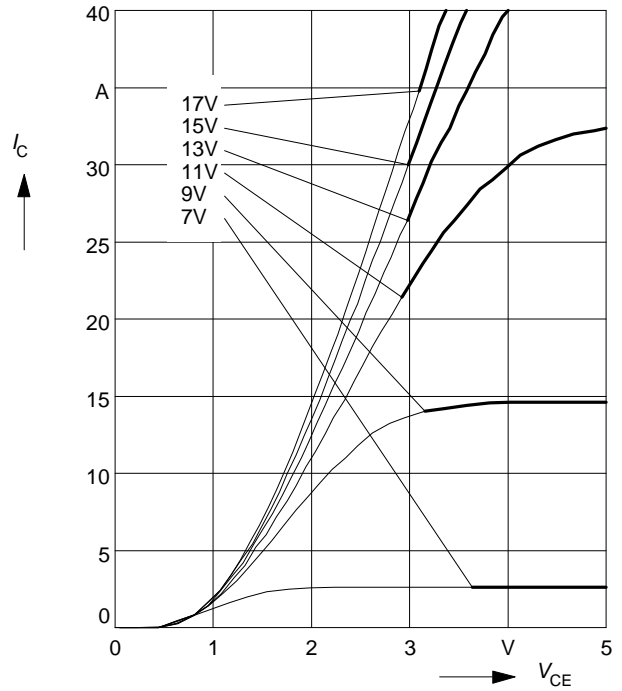

Typ. transfer characteristics

$I_C = f(V_{GE})$

parameter: $t_p = 250 \mu s, V_{CE} = 20 \text{ V}$

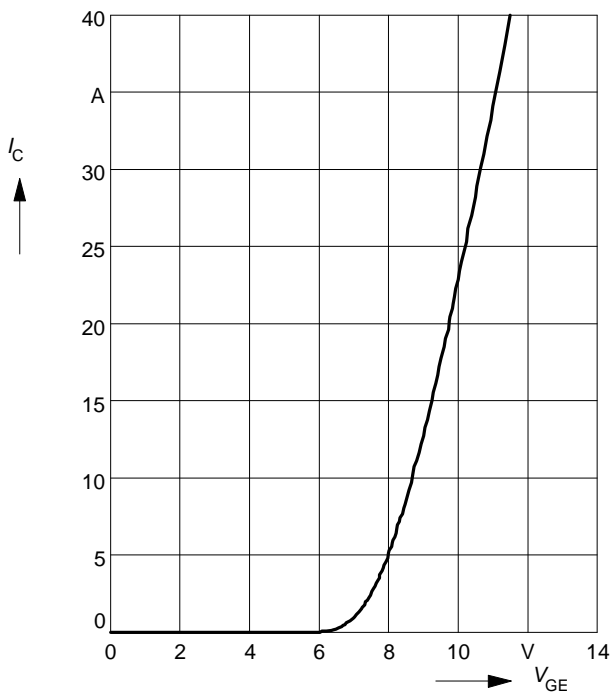

Typ. gate charge

$V_{GE} = f(Q_{Gate})$
 parameter: $I_{C\ puls} = 20\ A$

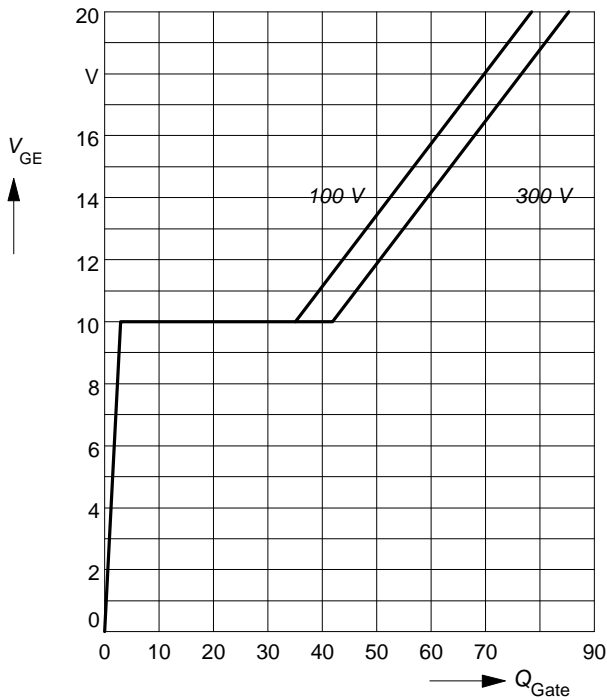

Typ. capacitances

$C = f(V_{CE})$
 parameter: $V_{GE} = 0\ V, f = 1\ MHz$

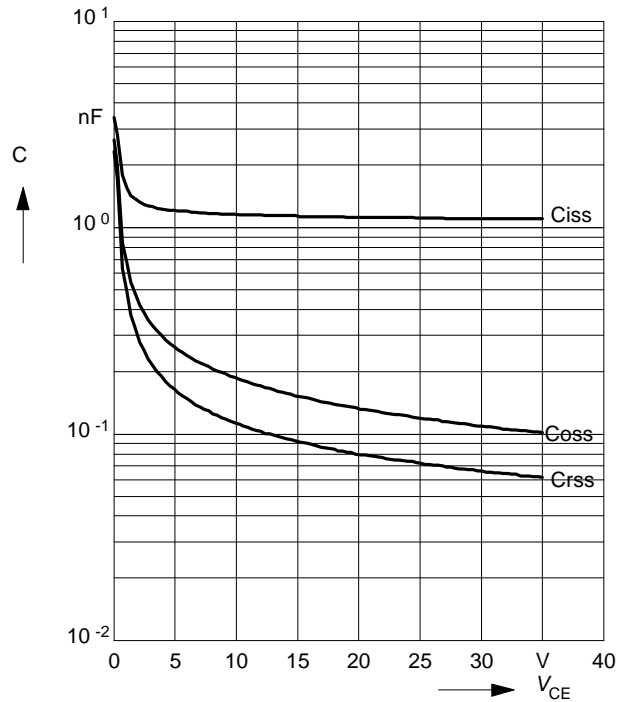

Reverse biased safe operating area

$I_{C\ puls} = f(V_{CE}), T_j = 150^\circ C$
 parameter: $V_{GE} = 15\ V$

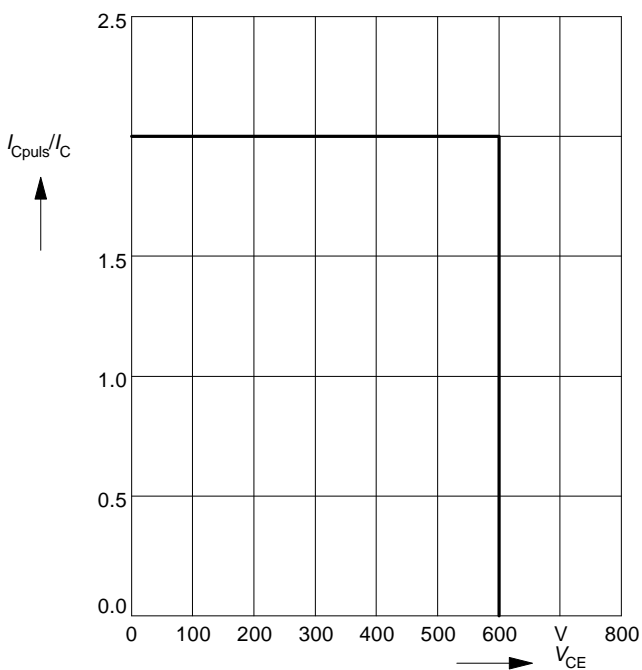

Short circuit safe operating area

$I_{C\ sc} = f(V_{CE}), T_j = 150^\circ C$
 parameter: $V_{GE} = \pm 15\ V, t_{sc} \le 10\ \mu s, L < 50\ nH$

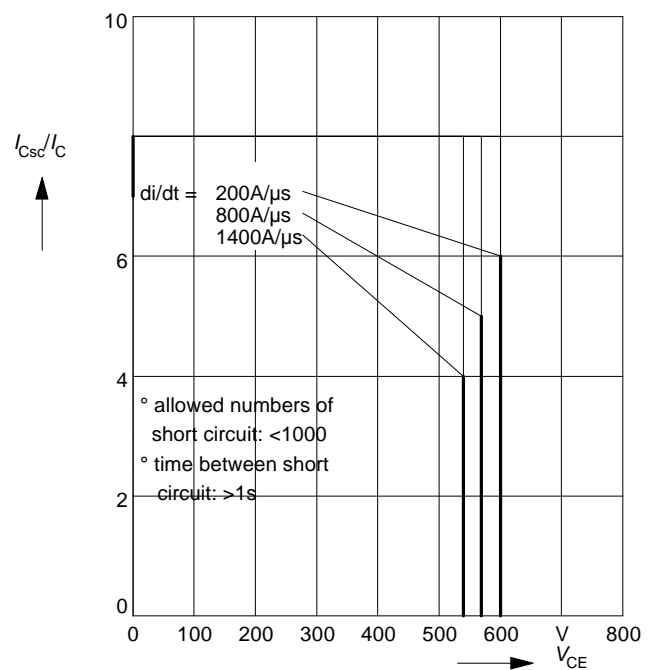

Typ. switching time

$t = f(I_C)$, inductive load, $T_j = 125^\circ\text{C}$
 par.: $V_{CE} = 300\text{ V}$, $V_{GE} = \pm 15\text{ V}$, $R_G = 47\ \Omega$

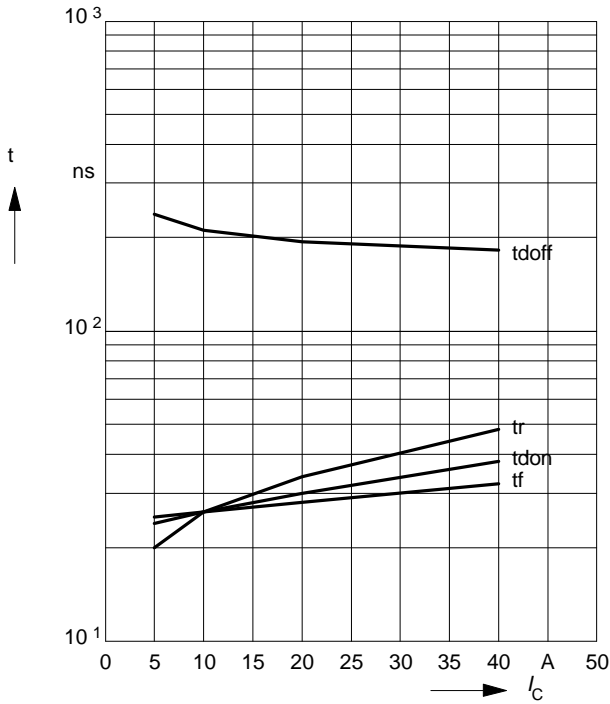

Typ. switching time

$t = f(R_G)$, inductive load, $T_j = 125^\circ\text{C}$
 par.: $V_{CE} = 300\text{ V}$, $V_{GE} = \pm 15\text{ V}$, $I_C = 20\text{ A}$

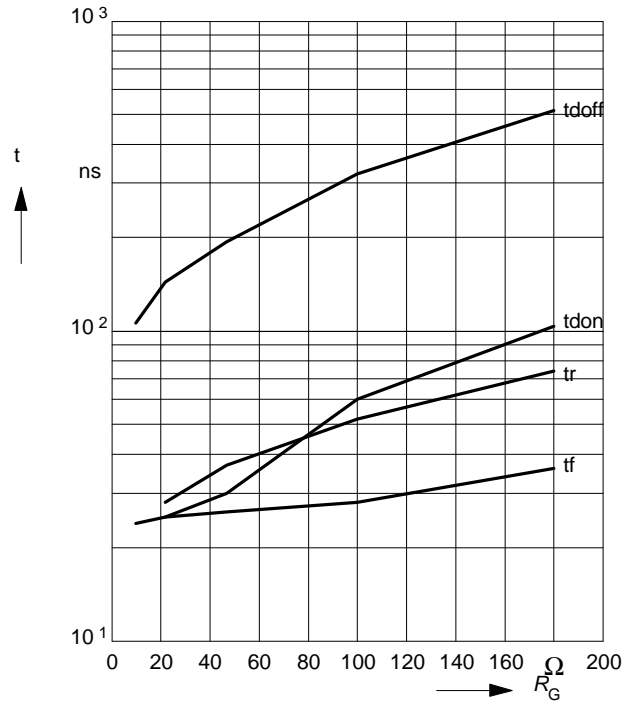

Typ. switching losses

$E = f(I_C)$, inductive load, $T_j = 125^\circ\text{C}$
 par.: $V_{CE} = 300\text{ V}$, $V_{GE} = \pm 15\text{ V}$, $R_G = 47\ \Omega$

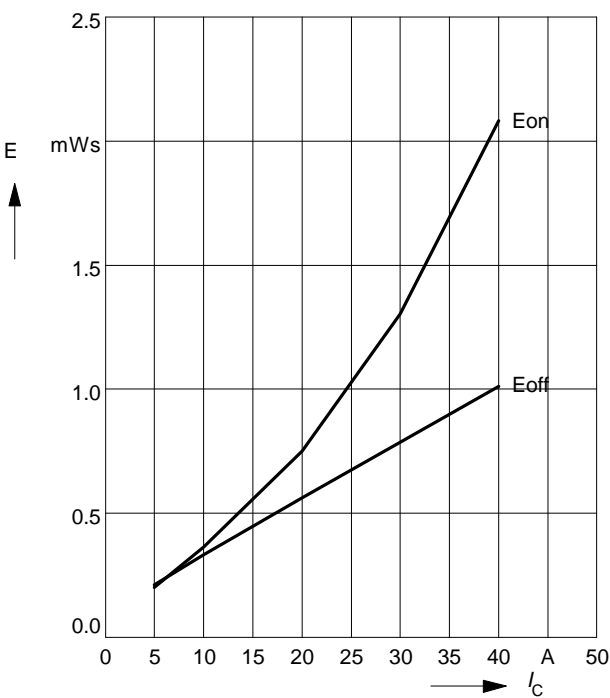

Typ. switching losses

$E = f(R_G)$, inductive load, $T_j = 125^\circ\text{C}$
 par.: $V_{CE} = 300\text{ V}$, $V_{GE} = \pm 15\text{ V}$, $I_C = 20\text{ A}$

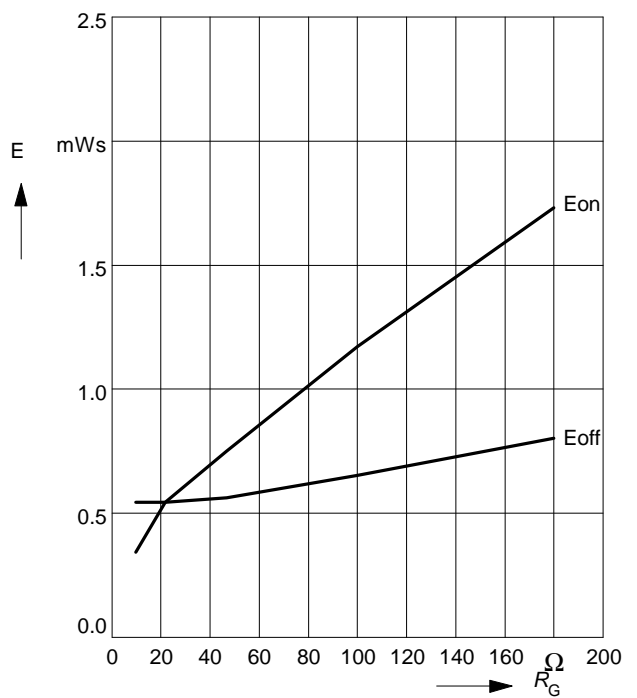

Forward characteristics of fast recovery

reverse diode $I_F = f(V_F)$

parameter: T_j

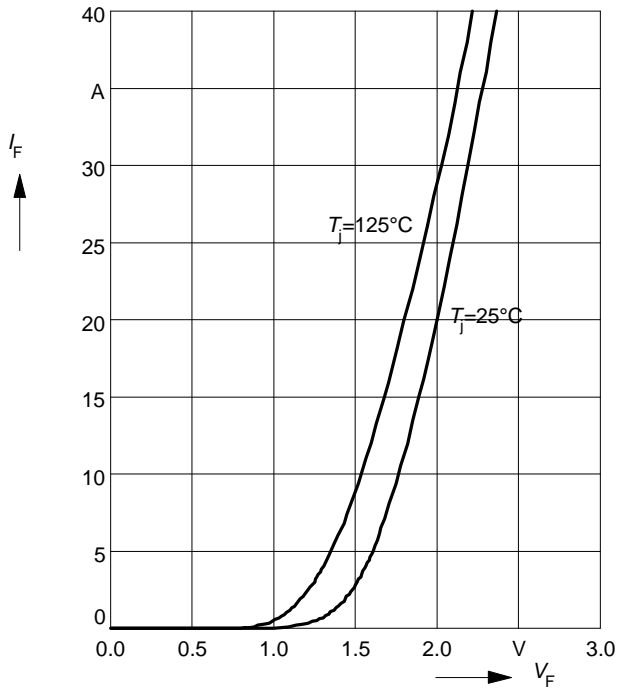

Transient thermal impedance Diode

$Z_{thJC} = f(t_p)$

parameter: $D = t_p / T$

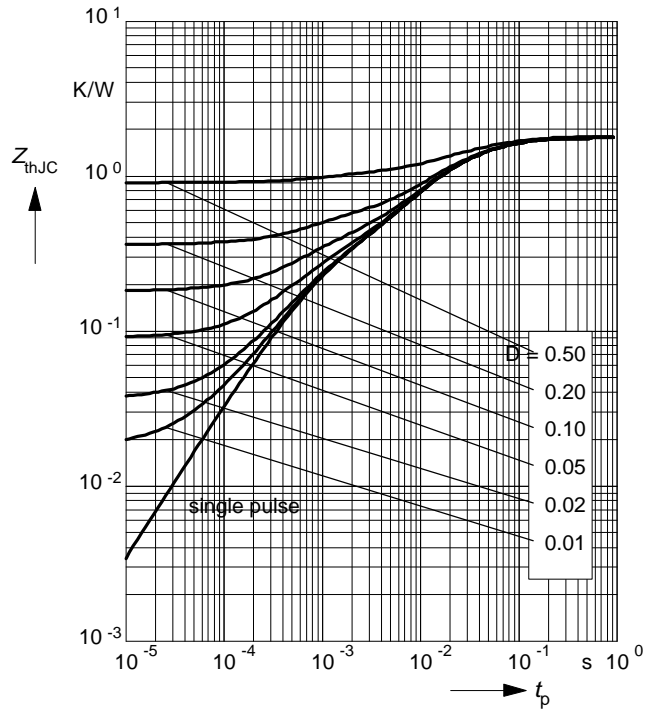

Circuit Diagram

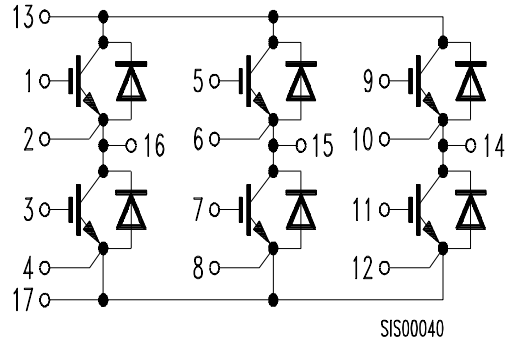

Package Outlines

Dimensions in mm

Weight: 180 g

