

**Broadband CATV, Coupler
5-1000MHz**

**MACPCT0040
V1P**

Features

- Surface Mount
- Typical Coupling +10dB
- 260°C Reflow Compatible
- RoHS* Compliant
- Available on Tape and Reel. Reel quantity 2000

Description

M/A-COM's MACPCT0040 is a 10dB broadband Coupler in a low cost, surface mount package. It offers low loss, good isolation, good input/output matching and exceptional coupling repeatability. Ideally suited for high volume CATV/Broadband applications.



Schematic

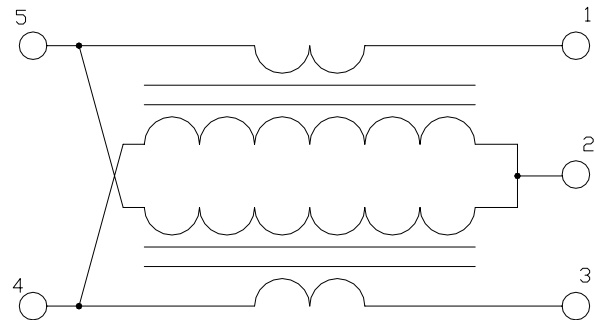

Case Style: SM-22B

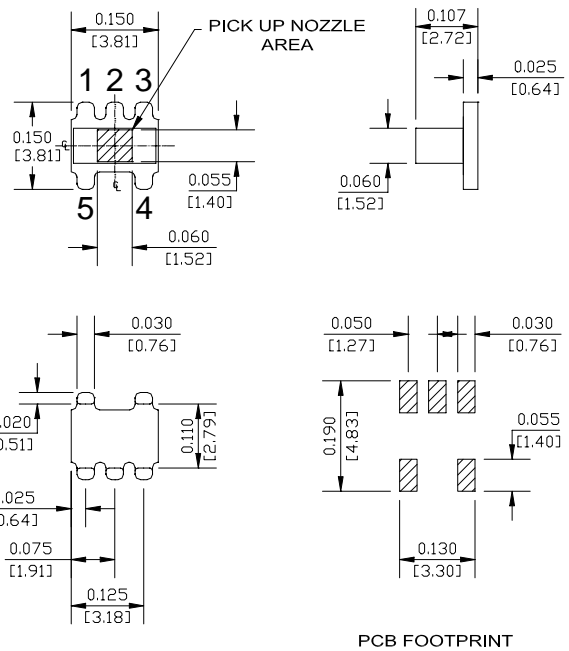

PCB FOOTPRINT

Dimensions in inches [mm] Tolerance: .xx ± .02, .xxx ± .010

Pin Configuration

Pin No.	Function
1	Input
2	Ground
3	Coupled
4	Isolated (external 50 Ohms termination)
5	Output

Ordering Information

Part Number	Package
MACPCT0040TR	2000 piece reel

Note: Reference Application Note **M513** for reel size information.

* Restrictions on Hazardous Substances, European Union Directive 2002/95/EC.

Electrical Specifications: $T_A = 25^\circ\text{C}$, $Z_0 = 50\Omega$ ¹

Parameter	Test Conditions	Units	Min	Typ	Max
Coupling	5 - 500 MHz	dB	-	9.95	10 ± 0.4
Coupling	500 - 1000 MHz	dB	-	9.9	10 ± 0.6
Main Line Loss	5—500MHz	dB	-	1.1	1.4
Main Line Loss	500 - 1000 MHz	dB	-	1.3	1.7
Directivity	5 - 50MHz	dB	20	22	-
Directivity	50—500MHz	dB	18	21	-
Directivity	500 - 1000 MHz	dB	13	18	-
Input Return Loss	5 - 1000 MHz	dB	16	21	-
Output Return Loss	5 - 50MHz	dB	20	30	-
Output Return Loss	50—500MHz	dB	28	40	-
Output Return Loss	500 - 1000 MHz	dB	20	35	-
Coupling Return Loss	5 - 500 MHz	dB	16	20	-
Coupling Return Loss	500 - 1000 MHz	dB	13	18	-
Isolation Return Loss	5 - 50MHz	dB	20	30	-
Isolation Return Loss	50—500MHz	dB	25	43	-
Isolation Return Loss	500 - 1000 MHz	dB	16	25	-

Absolute Maximum Ratings ^{1,2}

Parameter	Absolute Maximum
Max Input Power	250mW
DC current	30mA
Operating Temperature	-40°C to +85°C
Storage Temperature	-55°C to +100°C

1. Exceeding any one or combination of these limits may cause permanent damage to this device.
2. M/A-COM does not recommend sustained operation near these survivability limits.

Recommended PCB Configuration

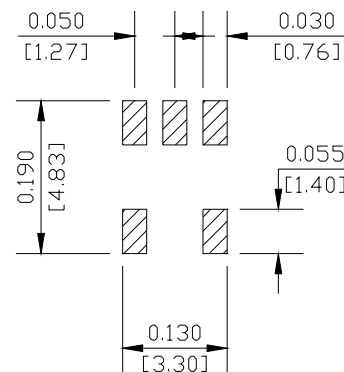

Typical Performance Curves $T_A = 25^\circ\text{C}$, $Z_0 = 50\Omega$

Coupling

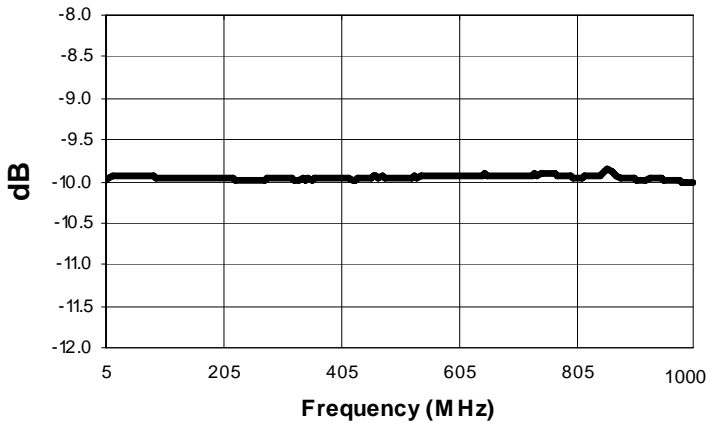

Main Line Loss

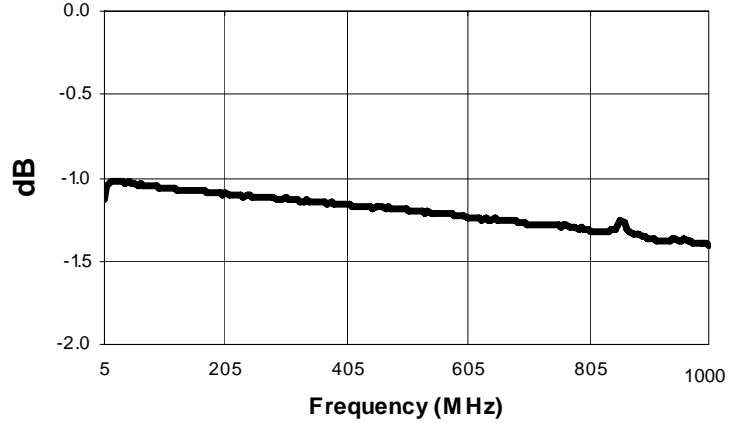

Directivity

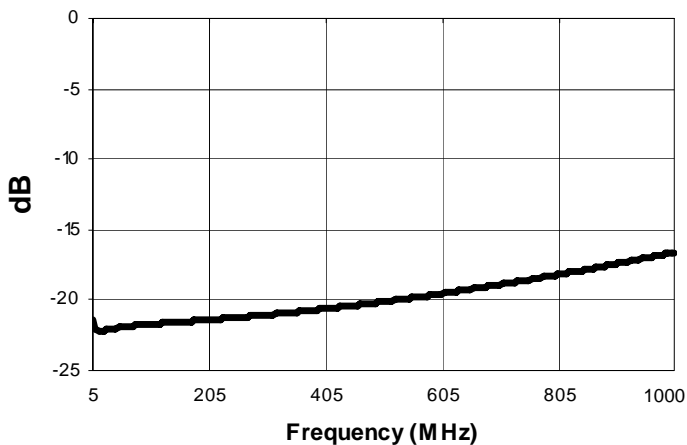

Input Return Loss

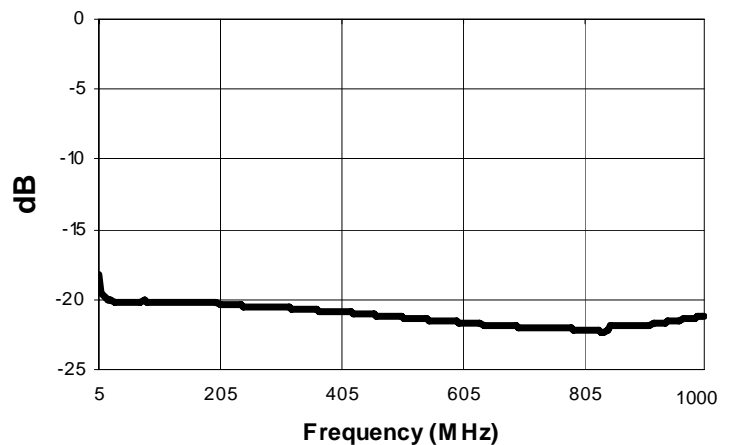

Output Return Loss

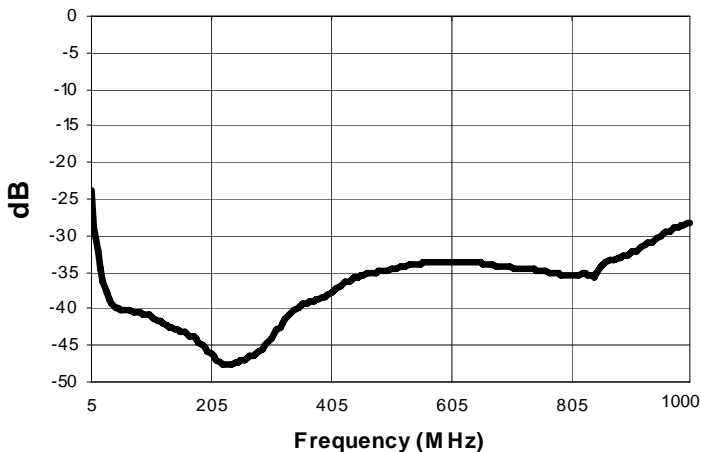

Coupling Return Loss

