

# Triacs

## Silicon Bidirectional Thyristors

... designed for full-wave ac control applications primarily in industrial environments needing noise immunity.

- Guaranteed High Commutation Voltage  
dv/dt — 500 V/μs Min @ T<sub>C</sub> = 25°C
- High Blocking Voltage — V<sub>DRM</sub> to 800 V
- Photo Glass Passivated Junction for Improved Power Cycling Capability and Reliability

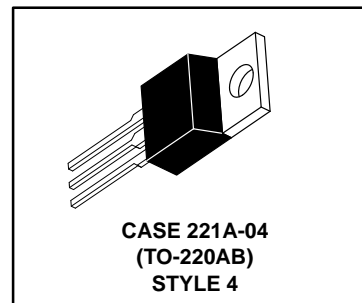
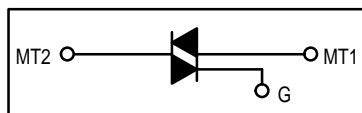

### MAXIMUM RATINGS (T<sub>C</sub> = 25°C unless otherwise noted.)

Rating	Symbol	Value	Unit
Peak Repetitive Off-State Voltage <sup>(1)</sup> (T <sub>J</sub> = -40 to +125°C, 1/2 Sine Wave 50 to 60 Hz, Open Gate)	V <sub>DRM</sub>		Volts
MAC321-4		200	
MAC321-6		400	
MAC321-8		600	
MAC321-10		800	
Peak Gate Voltage	V <sub>GM</sub>	10	Volts
On-State Current RMS (T <sub>C</sub> = +75°C Full Cycle Sine Wave 50 to 60 Hz)	I <sub>T(RMS)</sub>	20	Amp
Peak Surge Current (One Full Cycle, 60 Hz, T <sub>C</sub> = +75°C preceded and followed by Rated Current)	I <sub>TSM</sub>	150	Amp
Circuit Fusing Considerations (t = 8.3 ms)	I <sup>2</sup> t	93	A <sup>2</sup> s
Peak Gate Power (T <sub>C</sub> = +75°C, Pulse Width = 2.0 μs)	P <sub>GM</sub>	20	Watts
Average Gate Power (T <sub>C</sub> = +75°C, t = 8.3 ms)	P <sub>G(AV)</sub>	0.5	Watt
Peak Gate Current	I <sub>GM</sub>	2.0	Amp
Operating Junction Temperature Range	T <sub>J</sub>	-40 to +125	°C
Storage Temperature Range	T <sub>stg</sub>	-40 to +150	°C

### THERMAL CHARACTERISTICS

Characteristic	Symbol	Max	Unit
Thermal Resistance, Junction to Case	R <sub>θJC</sub>	1.8	°C/W

1. V<sub>DRM</sub> for all types can be applied on a continuous basis. Blocking voltages shall not be tested with a constant current source such that the voltage ratings of the devices are exceeded.

# MAC321 Series

## ELECTRICAL CHARACTERISTICS (T<sub>C</sub> = 25°C unless otherwise noted.)

Characteristic	Symbol	Min	Typ	Max	Unit
Peak Blocking Current (V <sub>D</sub> = Rated V <sub>DRM</sub> , Gate Open)  T <sub>J</sub> = 25°C T <sub>J</sub> = +125°C	I <sub>DRM</sub>	— —	— —	10 2.0	μA mA
Peak On-State Voltage (Either Direction) (I <sub>TM</sub> = 28 A Peak; Pulse Width ≤ 2.0 ms, Duty Cycle ≤ 2.0%)	V <sub>TM</sub>	—	1.4	1.7	Volts
Gate Trigger Current (Continuous dc) (Main Terminal Voltage = 12 Vdc, R <sub>L</sub> = 100 Ohms) MT2(+), G(+) MT2(+), G(-) MT2(-), G(-)	I <sub>GT</sub>	— — —	— — —	100 100 100	mA
Gate Trigger Voltage (Continuous dc) (Main Terminal Voltage = 12 Vdc, R <sub>L</sub> = 100 Ohms) MT2(+), G(+) MT2(+), G(-) MT2(-), G(-) (Main Terminal Voltage = Rated V <sub>DRM</sub> , R <sub>L</sub> = 10 kΩ, T <sub>J</sub> = +125°C) MT2(+), G(+); MT2(-), G(-); MT2(+), G(-)	V <sub>GT</sub>	— — — 0.2	— — — —	2.0 2.0 2.0 —	Volts
Holding Current (Either Direction) (Main Terminal Voltage = 12 Vdc, Gate Open, Initiating Current = 200 mA)	I <sub>H</sub>	—	—	100	mA
Turn-On Time (V <sub>D</sub> = Rated V <sub>DRM</sub> , I <sub>TM</sub> = 28 A, I <sub>GT</sub> = 120 mA, Rise Time = 0.1 μs, Pulse Width = 2.0 μs)	t <sub>gt</sub>	—	1.5	—	μs
Critical Rate of Rise of Off-State Voltage (V <sub>D</sub> = Rated V <sub>DRM</sub> , Exponential Voltage Rise, Gate Open)  T <sub>J</sub> = 25°C T <sub>J</sub> = +125°C	dv/dt(s)	500 200	— —	— —	V/μs

### TYPICAL CHARACTERISTICS

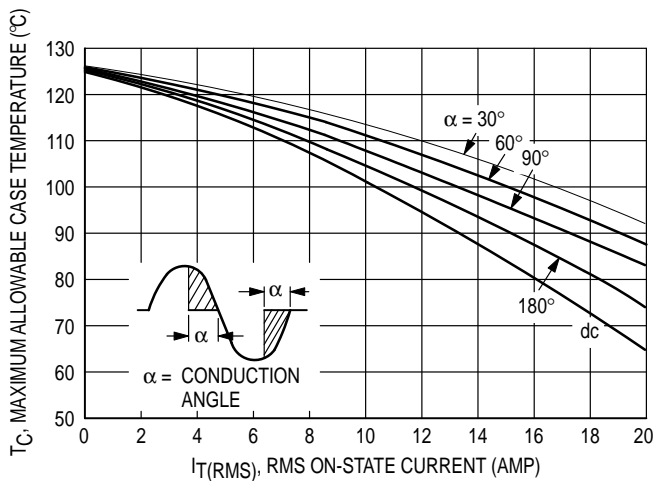

Figure 1. RMS Current Derating

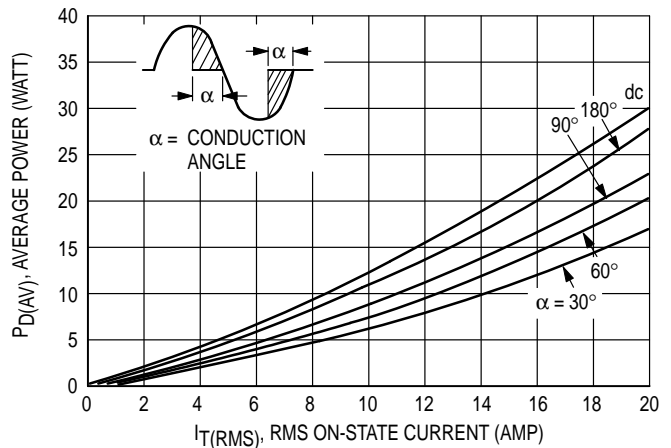

Figure 2. On-State Power Dissipation

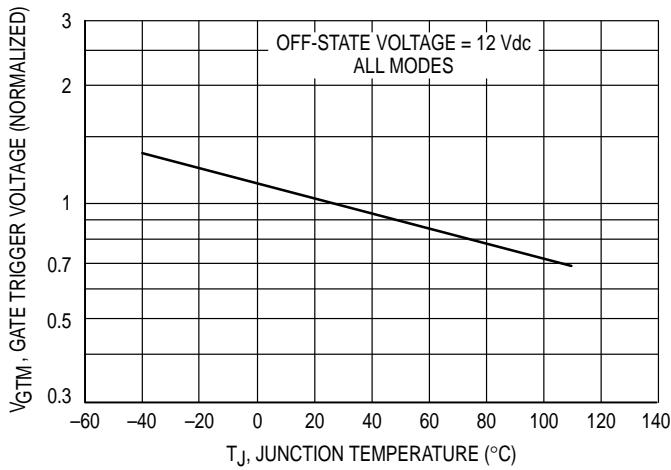

Figure 3. Typical Gate Trigger Voltage

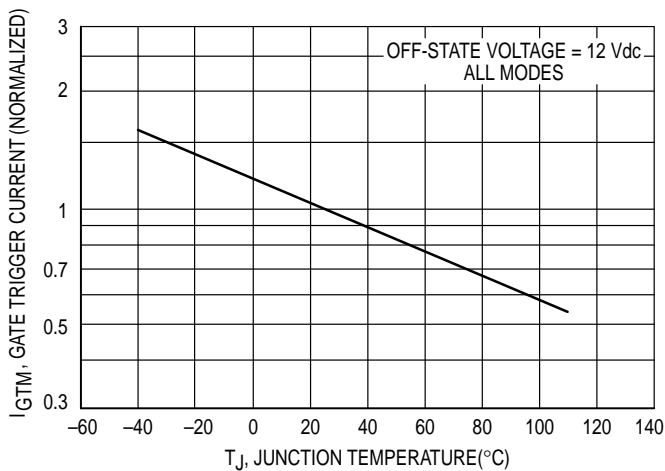

Figure 4. Typical Gate Trigger Current

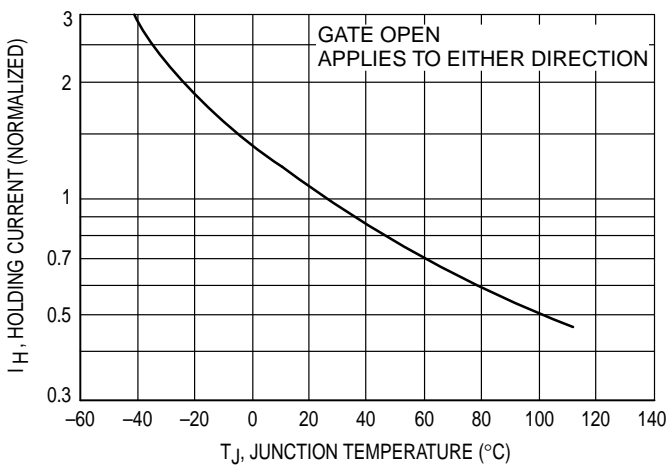

Figure 6. Typical Holding Current

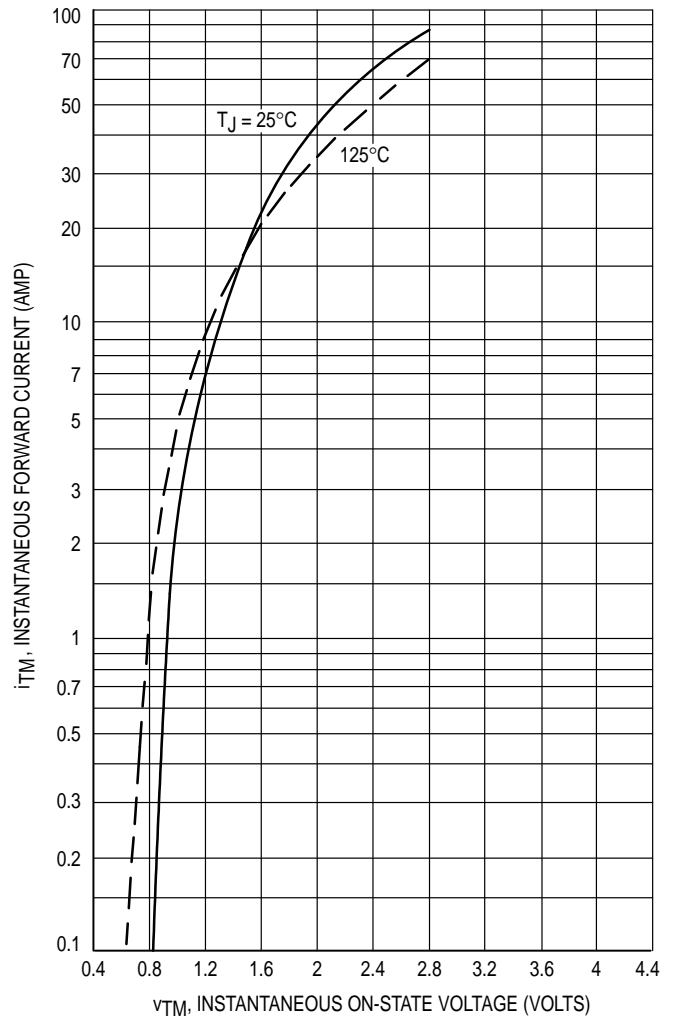

Figure 5. Maximum On-State Characteristics

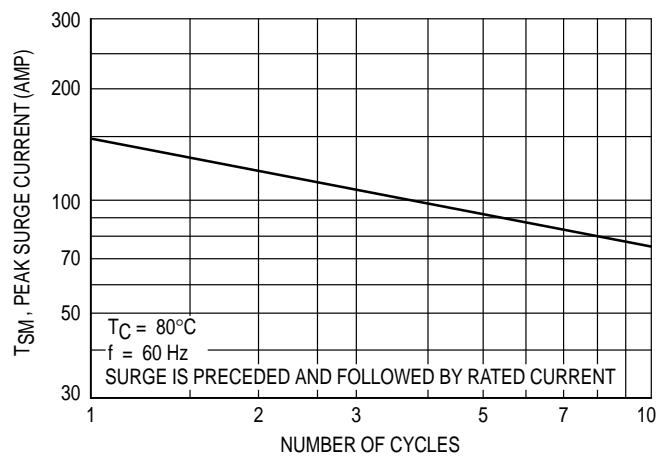

Figure 7. Maximum On-Repetitive Surge Current

# MAC321 Series

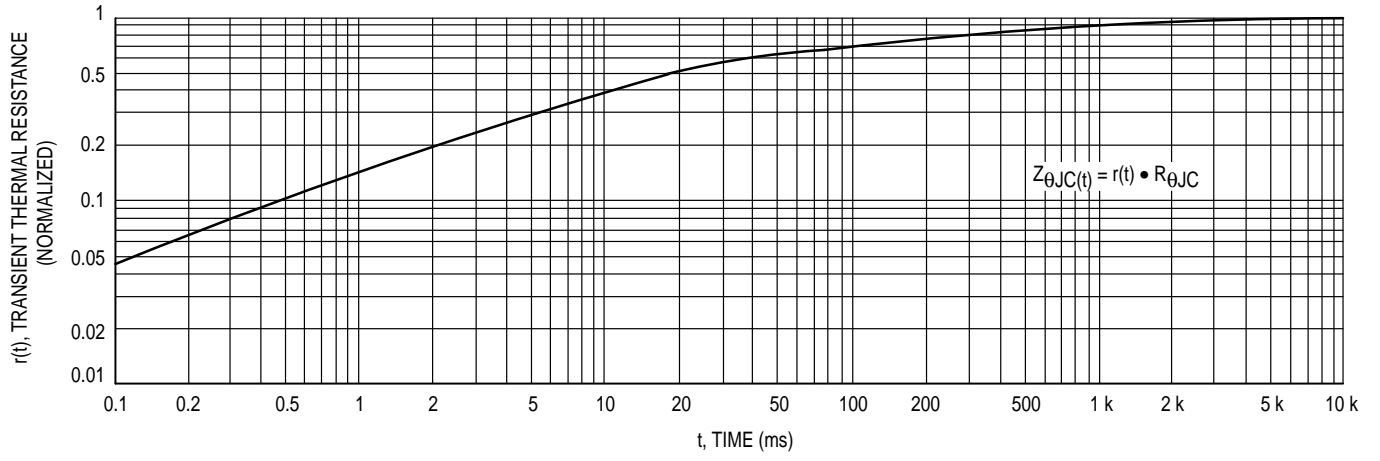
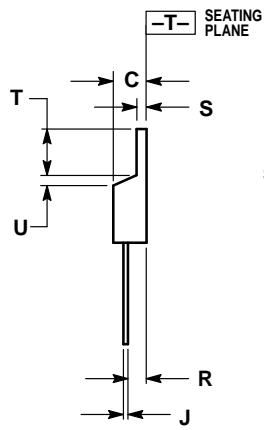
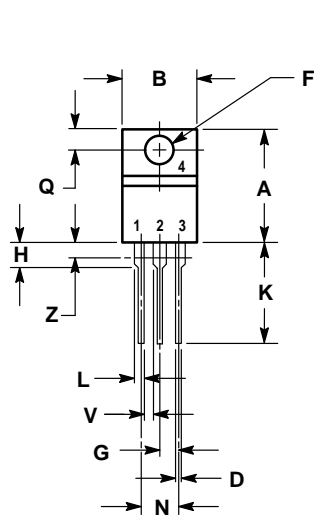

Figure 8. Thermal Response

PACKAGE DIMENSIONS



STYLE 4:  
 PIN 1. MAIN TERMINAL 1  
 PIN 2. MAIN TERMINAL 2  
 PIN 3. GATE  
 PIN 4. MAIN TERMINAL 2

- NOTES:  
 1. DIMENSIONING AND TOLERANCING PER ANSI Y14.5M, 1982.  
 2. CONTROLLING DIMENSION: INCH.  
 3. DIMENSION Z DEFINES A ZONE WHERE ALL BODY AND LEAD IRREGULARITIES ARE ALLOWED.

DIM	INCHES		MILLIMETERS	
	MIN	MAX	MIN	MAX
A	0.570	0.620	14.48	15.75
B	0.380	0.405	9.66	10.28
C	0.160	0.190	4.07	4.82
D	0.025	0.035	0.64	0.88
F	0.142	0.147	3.61	3.73
G	0.095	0.105	2.42	2.66
H	0.110	0.155	2.80	3.93
J	0.014	0.022	0.36	0.55
K	0.500	0.562	12.70	14.27
L	0.045	0.055	1.15	1.39
N	0.190	0.210	4.83	5.33
Q	0.100	0.120	2.54	3.04
R	0.080	0.110	2.04	2.79
S	0.045	0.055	1.15	1.39
T	0.235	0.255	5.97	6.47
U	0.000	0.050	0.00	1.27
V	0.045	—	1.15	—
Z	—	0.080	—	2.04

CASE 221A-04  
 (TO-220AB)

## MAC321 Series

Motorola reserves the right to make changes without further notice to any products herein. Motorola makes no warranty, representation or guarantee regarding the suitability of its products for any particular purpose, nor does Motorola assume any liability arising out of the application or use of any product or circuit, and specifically disclaims any and all liability, including without limitation consequential or incidental damages. "Typical" parameters can and do vary in different applications. All operating parameters, including "Typicals" must be validated for each customer application by customer's technical experts. Motorola does not convey any license under its patent rights nor the rights of others. Motorola products are not designed, intended, or authorized for use as components in systems intended for surgical implant into the body, or other applications intended to support or sustain life, or for any other application in which the failure of the Motorola product could create a situation where personal injury or death may occur. Should Buyer purchase or use Motorola products for any such unintended or unauthorized application, Buyer shall indemnify and hold Motorola and its officers, employees, subsidiaries, affiliates, and distributors harmless against all claims, costs, damages, and expenses, and reasonable attorney fees arising out of, directly or indirectly, any claim of personal injury or death associated with such unintended or unauthorized use, even if such claim alleges that Motorola was negligent regarding the design or manufacture of the part. Motorola and <sup>®</sup> are registered trademarks of Motorola, Inc. Motorola, Inc. is an Equal Opportunity/Affirmative Action Employer.

### Literature Distribution Centers:

USA: Motorola Literature Distribution; P.O. Box 20912; Phoenix, Arizona 85036.

EUROPE: Motorola Ltd.; European Literature Centre; 88 Tanners Drive, Blakelands, Milton Keynes, MK14 5BP, England.

JAPAN: Nippon Motorola Ltd.; 4-32-1, Nishi-Gotanda, Shinagawa-ku, Tokyo 141, Japan.

ASIA PACIFIC: Motorola Semiconductors H.K. Ltd.; Silicon Harbour Center, No. 2 Dai King Street, Tai Po Industrial Estate, Tai Po, N.T., Hong Kong.



MAC321/D

