

Triacs

Silicon Bidirectional Thyristors

... designed primarily for full-wave ac control applications, such as solid-state relays, motor controls, heating controls and power supplies; or wherever full-wave silicon gate controlled solid-state devices are needed. Triac type thyristors switch from a blocking to a conducting state for either polarity of applied anode voltage with positive or negative gate triggering.

- Blocking Voltage to 800 Volts
- All Diffused and Glass Passivated Junctions for Greater Parameter Uniformity and Stability
- Small, Rugged, Thermowatt Construction for Low Thermal Resistance, High Heat Dissipation and Durability
- Gate Triggering Guaranteed in Three Modes (MAC15FP Series) or Four Modes (MAC15AFP Series)

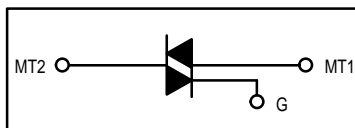

MAC15FP
Series
MAC15AFP
Series

ISOLATED TRIACs
THYRISTORS
15 AMPERES RMS
200 thru 800 VOLTS

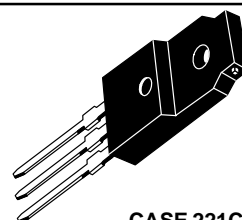

CASE 221C-02
STYLE 3

MAXIMUM RATINGS ($T_J = 25^\circ\text{C}$ unless otherwise noted.)

Rating	Symbol	Value	Unit
Repetitive Peak Off-State Voltage ⁽¹⁾ ($T_J = -40$ to $+125^\circ\text{C}$, 1/2 Sine Wave 50 to 60 Hz, Gate Open)	V_{DRM}	200 400 600 800	Volts
On-State RMS Current ($T_C = +80^\circ\text{C}$) ⁽²⁾ Full Cycle Sine Wave 50 to 60 Hz ($T_C = +95^\circ\text{C}$)	$I_{\text{T(RMS)}}$	15 12	Amps
Peak Nonrepetitive Surge Current (One Full Cycle, 60 Hz, $T_C = +80^\circ\text{C}$) preceded and followed by rated current	I_{TSM}	150	Amps
Peak Gate Power ($T_C = +80^\circ\text{C}$, Pulse Width = 2 μs)	P_{GM}	20	Watts
Average Gate Power ($T_C = +80^\circ\text{C}$, $t = 8.3$ ms)	$P_{\text{G(AV)}}$	0.5	Watt
Peak Gate Current	I_{GM}	2	Amps
Peak Gate Voltage	V_{GM}	10	Volts
RMS Isolation Voltage ($T_A = 25^\circ\text{C}$, Relative Humidity $\leq 20\%$)	$V_{\text{(ISO)}}$	1500	Volts
Operating Junction Temperature	T_J	-40 to +125	$^\circ\text{C}$
Storage Temperature Range	T_{stg}	-40 to +150	$^\circ\text{C}$

1. V_{DRM} for all types can be applied on a continuous basis. Blocking voltages shall not be tested with a constant current source such that the voltage ratings of the devices are exceeded.
2. The case temperature reference point for all T_C measurements is a point on the center lead of the package as close as possible to the plastic body.

MAC15FP Series MAC15AFP Series

THERMAL CHARACTERISTICS

Characteristic	Symbol	Max	Unit
Thermal Resistance, Junction to Case	$R_{\theta JC}$	2	$^{\circ}C/W$
Thermal Resistance, Case to Sink	$R_{\theta CS}$	2.2 (typ)	$^{\circ}C/W$
Thermal Resistance, Junction to Ambient	$R_{\theta JA}$	60	$^{\circ}C/W$

ELECTRICAL CHARACTERISTICS ($T_C = 25^{\circ}C$ unless otherwise noted.)

Characteristic	Symbol	Min	Typ	Max	Unit
Peak Blocking Current (Either Direction) $T_J = 25^{\circ}C$ ($V_D = \text{Rated } V_{DRM}$, $T_J = 125^{\circ}C$, Gate Open)	I_{DRM}	—	—	10 2	μA mA
Peak On-State Voltage (Either Direction) ($I_{TM} = 21$ A Peak; Pulse Width = 1 to 2 ms, Duty Cycle $\leq 2\%$)	V_{TM}	—	1.3	1.6	Volts
Gate Trigger Current (Continuous dc) (Main Terminal Voltage = 12 Vdc, $R_L = 100$ Ohms) MT2(+), G(+) MT2(+), G(-) MT2(-), G(-) MT2(-), G(+) "A" SUFFIX ONLY	I_{GT}	— — — —	— — — —	50 50 50 75	mA
Gate Trigger Voltage (Continuous dc) (Main Terminal Voltage = 12 Vdc, $R_L = 100$ Ohms) MT2(+), G(+) MT2(+), G(-) MT2(-), G(-) MT2(-), G(+) "A" SUFFIX ONLY (Main Terminal Voltage = Rated V_{DRM} , $R_L = 10$ k Ω , $T_J = +110^{\circ}C$) MT2(+), G(+); MT2(-), G(-); MT2(+), G(-) MT2(-), G(+) "A" SUFFIX ONLY	V_{GT}	— — — — 0.2 0.2	0.9 0.9 1.1 1.4 — —	2 2 2 2.5 — —	Volts
Holding Current (Either Direction) (Main Terminal Voltage = 12 Vdc, Gate Open, Initiating Current = 200 mA)	I_H	—	6	40	mA
Turn-On Time ($V_D = \text{Rated } V_{DRM}$, $I_{TM} = 17$ A, $I_{GT} = 120$ mA, Rise Time = 0.1 μs , Pulse Width = 2 μs)	t_{gt}	—	1.5	—	μs
Critical Rate of Rise of Commutation Voltage ($V_D = \text{Rated } V_{DRM}$, $I_{TM} = 21$ A, Commutating $di/dt = 7.6$ A/ms, Gate Unenergized, $T_C = 80^{\circ}C$)	$dv/dt(c)$	—	5	—	V/ μs

QUADRANT DEFINITIONS

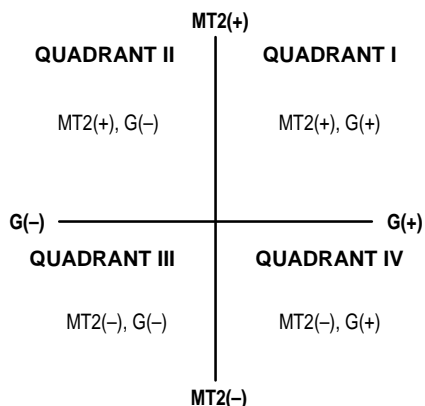

Trigger devices are recommended for gating on Triacs. They provide:

1. Consistent predictable turn-on points.
2. Simplified circuitry.
3. Fast turn-on time for cooler, more efficient and reliable operation.

ELECTRICAL CHARACTERISTICS of RECOMMENDED BIDIRECTIONAL SWITCHES

Usage	General	
Part Number	MBS4991	MBS4992
V_S	6–10 V	7.5–9 V
I_S	350 μA Max	120 μA Max
$V_{S1}-V_{S2}$	0.5 V Max	0.2 V Max
Temperature Coefficient	0.02%/ $^{\circ}C$ Typ	

1. Ratings apply for open gate conditions. Thyristor devices shall not be tested with a constant current source for blocking capability such that the voltage applied exceeds the rated blocking voltage.

TYPICAL CHARACTERISTICS

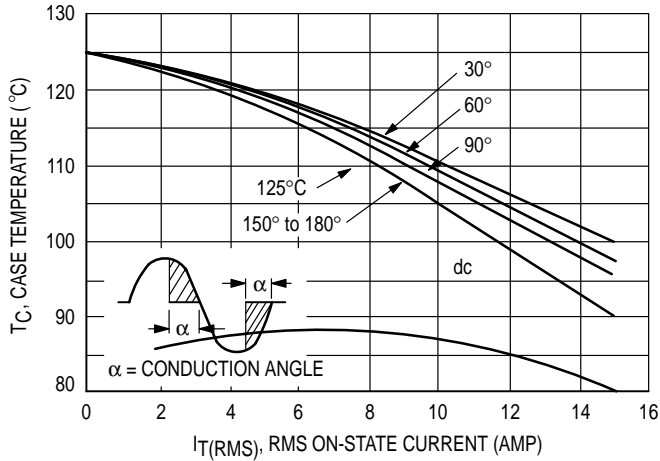

Figure 1. RMS Current Derating

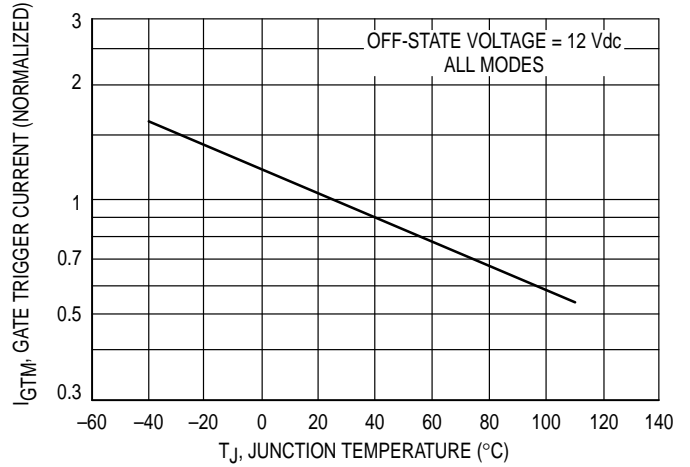

Figure 4. Typical Gate Trigger Current

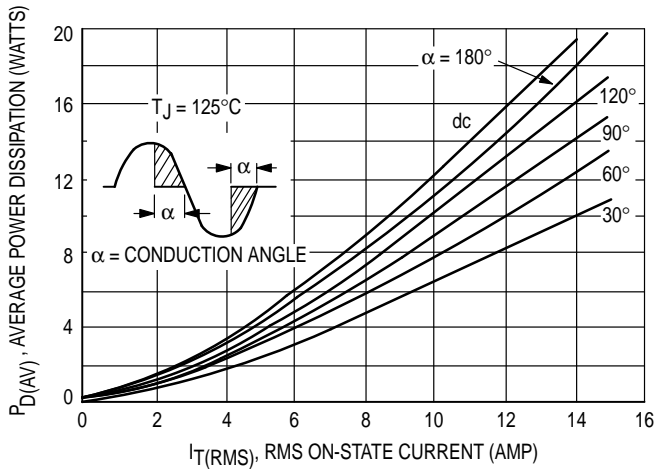

Figure 2. On-State Power Dissipation

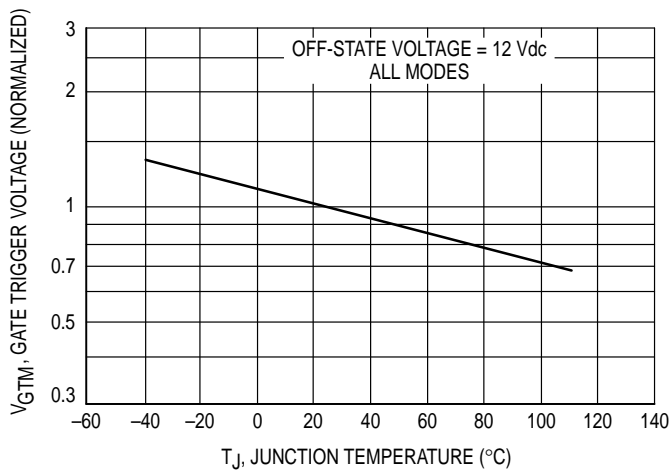

Figure 3. Typical Gate Trigger Voltage

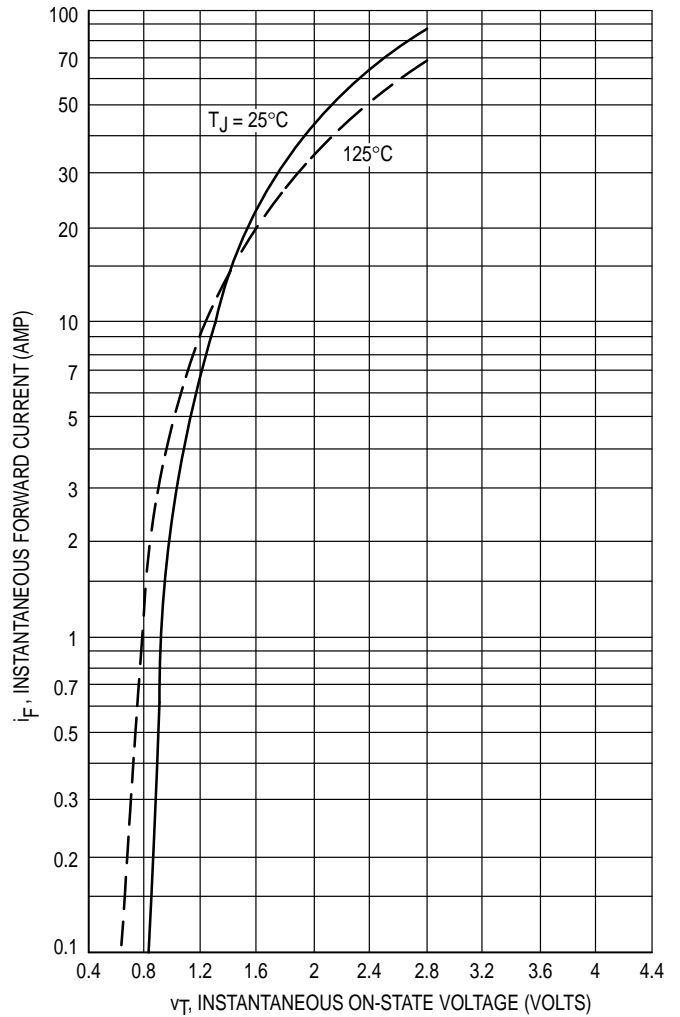

Figure 5. Maximum On-State Characteristics

MAC15FP Series MAC15AFP Series

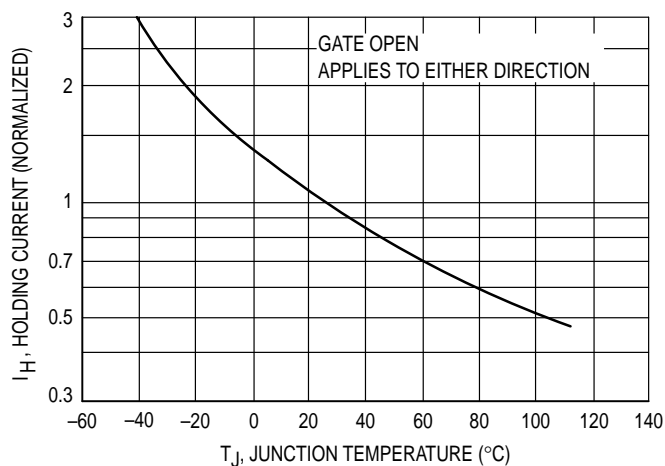

Figure 6. Typical Holding Current

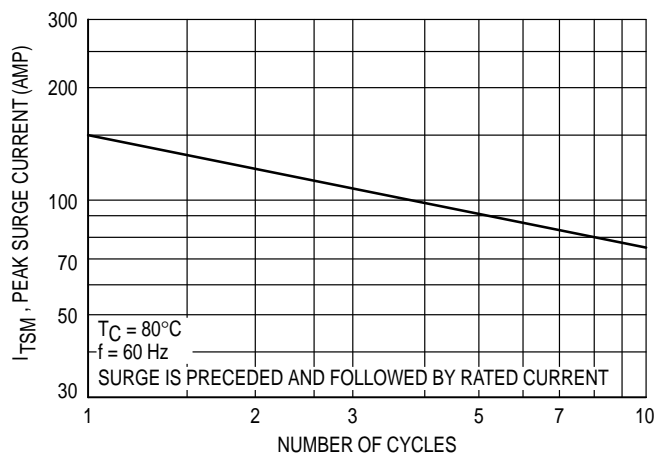

Figure 7. Maximum Nonrepetitive Surge Current

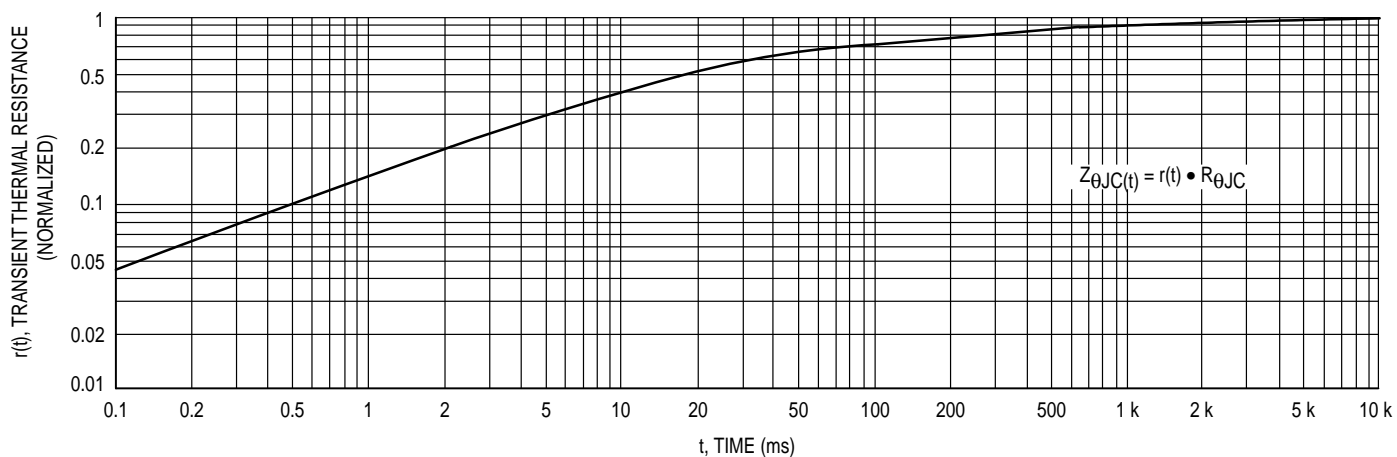

Figure 8. Thermal Response