

DATA SHEET

Introduction and Applications for Ceramic Band Pass Filters

Features

- High Q ceramic
- Rugged
- Temperature compensated
- Custom designs

Benefits

- Low insertion loss
- Small compact design
- Frequency stability
- Mechanical stability

Introduction

Skyworks is a world-class supplier of high performance ceramic band pass filters. Specializing in band pass, notch and diplexing applications, Skyworks can cover a frequency range from 300 MHz to 6000 MHz with surface mount or connectorized devices. Utilizing state of the art assembly automation, Skyworks provides cost-effective solutions meeting high performance specifications.

Skyworks' surface mount PCB configured filters are designed to comply with "green" manufacturing initiatives eliminating heavy metal elements. This configuration is designed to comply with pending European regulations regarding the elimination of lead in electronic assemblies. Custom assemblies can be obtained with flat pack style SMT devices, through-hole or Sn/Pb coated PCB surface mount designs.

Skyworks' assembly methodology offers a wide array of designs, from 2 mm x 2 pole – 8 mm x 10 pole band pass filters and diplexers, to advanced band stop (notch) designs and high-pass or low-pass filters. For typical applications and ranges of products, refer to the Standard Filters/Duplexers listing included in this document. Detailed specifications, both mechanical and electrical, are maintained for many popular designs on our Website, or by contacting your local sales representative.

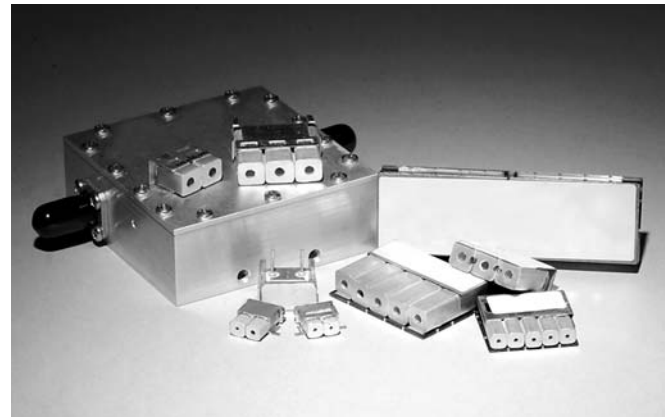

The nature of applications utilizing a band pass filter, duplexer or notch filter, necessitates the close interaction of the customer and Skyworks' application engineering. Our application engineers employ the latest in simulation and circuit analysis software with accurately defined design rules to provide rapid turnaround on new filter designs. With our experience and design aids, Skyworks can provide the necessary support for your application from prototype through production. In addition to the personal attention, Skyworks offers a computer-aided design tool, CRaFT, to assist engineers designing filters (the latest version can be downloaded from our web site, www.skyworksinc.com).

The strength of Skyworks' designs begin with our ability to produce our own coaxial resonators from proprietary ceramic formulations. These resonators provide a high Q element that allows us to maintain our low filter insertion loss values. With numerous design package styles, Skyworks offers aggressive leadtimes on both prototype and volume applications.

*These products are produced by Trans-Tech (a wholly-owned subsidiary of Skyworks Solutions, Inc.)

Standard Filter Selection Guide

Skyworks has a wide range of standard filters, as well as the capability to rapidly create new custom designs. Figure 1.1 illustrates our general capability for filters. If a desired requirement falls within the listed categories, Skyworks can easily offer a suitable design. Beyond this general list, Skyworks has a staff of experienced filter designers who can provide new custom and more technologically difficult filters. In addition, the CRaFT program functions as a useful tool when analyzing filter requirements. Skyworks welcomes the chance to review specifications and determine a design solution.

Standard Filters/Duplexers*

This list contains Skyworks' most popular filter and diplexer designs. A variety of footprints and configurations are available for application-specific needs. Please contact the factory or your local representative with your specifications or for more information on any of these designs. Skyworks maintains a list of over 700 active filters and duplexers. We welcome every opportunity to assist in the selection or creation of a filter or diplexer that will meet your specifications.

Figure 1.1 Standard Capabilities*

Center frequency	300 MHz to 6 GHz
Standard filter type	Ceramic band pass, duplexer, notch, LPF
Number of poles	2–10
Resonator sizes	2, 3, 4, 6, 8 and 12
Bandwidth	1.0%–10% (May vary depending on resonator size, F_0 & ϵ_r)
Insertion loss	1–4 dB typical by design
Attenuation	Varies by number of poles
Impedance	50 or 75 Ω
VSWR	2.0:1 maximum
Operating temperature range	-40 to +85 °C
Mechanical packaging options	PCB surface mount, thru-hole, & flat pack surface mount
Power handling (continuous)	1 W typical*

* Contact Skyworks application engineering for assistance with any other requirement.

CATV (400–550 MHz/1000–1100 MHz)

Part Number	Filter Type	Size/Poles	Center Frequency (MHz)	Bandwidth (MHz)	Insertion Loss (dB)	Package
TT6P3-0427.5T-0125	Band pass	6 mm/3 pole	427.50	1	2.5	Through-hole
TT6P3-0439T-0150	Band pass	6 mm/3 pole	439.00	1	5.0	Through-hole
TT6P3-0445T-0145	Band pass	6 mm/3 pole	445.00	1	4.5	Through-hole
TT6P3-0451T-0150	Band pass	6 mm/3 pole	451.00	1	5.0	Through-hole
TT6P3-0495.25T-0145	Band pass	6 mm/3 pole	495.25	1	4.5	Through-hole
TT6P3-0527.25T-0145	Band pass	6 mm/3 pole	527.25	1	4.5	Through-hole
TT6P3-0547.25T-0145	Band pass	6 mm/3 pole	547.25	1	4.5	Through-hole
TT4P3-1000P0-2525	Band pass	4 mm/3 pole	1000.00	25	2.5	PCB SMT
TT6P4-1090P0-1050	Band pass	6 mm/4 pole	1090.00	10	5.0	PCB SMT

WCS (746–794 MHz/2305–2360 MHz/3650–3700 MHz/4940–4990 MHz)

Part Number	Filter Type	Size/Poles	Center Frequency (MHz)	Bandwidth (MHz)	Insertion Loss (dB)	Package
TT2P6-0757P0-7540	Band pass	2 mm/6 pole	757	75	4.0	PCB SMT
TT6P6-0785P6-3022	Band pass	6 mm/6 pole	785	30	2.2	PCB SMT
TT6P5-0794P3-2430	Band pass	6 mm/5 pole	794	24	3.0	PCB SMT
TT4P2-2332.5P2-2730	Band pass	4 mm/2 pole	2332.5	27	3.0	PCB SMT
TT6P5-2312P1-7032	Band pass	6 mm/5 pole	2312	70	3.2	PCB SMT
TT6P5-2340P1-12032	Band pass	6 mm/5 pole	2340	120	3.2	PCB SMT
TT6P4-3650P1-50014	Band pass	6 mm/4 pole	3650	500	1.4	PCB SMT
TT6P3-3675P0-5020	Band pass	6 mm/3 pole	3675	50	2.0	PCB SMT
TT4P4-T2382-R2518	Diplexer	4 mm/4 pole	T2382/R2518			PCB SMT
TT6P7-T0712-R0757	Diplexer	6 mm/4 x 3 pole	T712/R757			PCB SMT

*These products are produced by Trans-Tech (a subsidiary of Skyworks)

MDS (2110–2160 MHz/2500–2690 MHz)

Part Number	Filter Type	Size/Poles	Center Frequency (MHz)	Bandwidth (MHz)	Insertion Loss (dB)	Package
TT3P2-2110P0-2426	Band pass	3 mm/2 pole	2110	24	2.6	PCB SMT
TT4P3-2120P2-6020	Band pass	4 mm/3 pole	2120	60	2.0	PCB SMT
TT3P4-2140P1-10030	Band pass	3 mm/4 pole	2140	100	3.0	PCB SMT
TT3P3-2521P0-4220	Band pass	3 mm/3 pole	2521	42	2.0	PCB SMT
TT4P4-2593P1-18620	Band pass	4 mm/4 pole	2593	186	2.0	PCB SMT
TT4P4-2600P2-20020	Band pass	4 mm/4 pole	2600	200	2.0	PCB SMT
TT6P5-2640P1-7032	Band pass	6 mm/5 pole	2640	70	3.2	PCB SMT
TT6P6-T2534-R2653	Diplexer	6 mm/3 x 3 pole	T2534/R2653			PCB SMT

ISM (900–930 MHz/2400–2484 MHz/5650–5830 MHz)

Part Number	Filter Type	Size/Poles	Center Frequency (MHz)	Bandwidth (MHz)	Insertion Loss (dB)	Package
TT4P2-0915P2-2620	Band pass	4 mm/2 pole	915	26	2.0	PCB SMT
TT6P2-0915F-1425	Band pass	6 mm/2 pole	915	14	2.5	Flatpack SMT
TT6P3-0927T-0240	Band pass	6 mm/3 pole	927	2	4.0	Through-hole
TT6P5-2440P0-4830	Band pass	6 mm/5 pole	2440	48	30	Through-hole
TT4P3-2400P1-20015	Band pass	4 mm/3 pole	2400	200	1.5	PCB SMT
TT6P3-2400P2-0420	Band pass	6 mm/3 pole	2400	4	2.0	PCB SMT
TT4P4-5250P0-20017	Band pass	4 mm/4 pole	5250	200	1.7	PCB SMT
TT4P4-5300P0-20017	Band pass	4 mm/4 pole	5300	200	1.7	PCB SMT
TT4P4-5775P0-10030	Band pass	4 mm/4 pole	5775	100	3.0	PCB SMT
TT4P4-5795P0-15017	Band pass	4 mm/4 pole	5795	250	1.7	PCB SMT
TT4P8-T5250-T5795	Diplexer	4 mm/4 x 4 pole	T5250/R5795			PCB SMT

PCS Data (1910–1930 MHz)

Part Number	Filter Type	Size/Poles	Center Frequency (MHz)	Bandwidth (MHz)	Insertion Loss (dB)	Package
TT6P4-1910P3-2140	Band pass	6 mm/4 pole	1910	21	4.0	PCB SMT
TT6P4-1930P3-2030	Band pass	6 mm/4 pole	1930	20	3.0	PCB SMT
TT3P4-0836.5P2-2525	Band pass	3 mm/4 pole	0836.5	25	2.5	PCB SMT
TT3P4-0881.5P2-2525	Band pass	3 mm/4 pole	0881.5	25	2.5	PCB SMT

Cellular/PCS/DCS/UMTS (836–882 MHz/1880–1960 MHz/2140–2360 MHz)

Part Number	Filter Type	Size/Poles	Center Frequency (MHz)	Bandwidth (MHz)	Insertion Loss (dB)	Package
TT3P3-0836.5P0-2526	Band pass	3 mm/3 pole	836.5	25	2.6	PCB SMT
TT3P3-0881.5P0-2526	Band pass	3 mm/3 pole	881.5	25	2.6	PCB SMT
TT4P3-0863P0-0585	Band pass	4 mm/3 pole	863	5	8.5	PCB SMT
TT6P5-881.5P0-2530	Band pass	6 mm/5 pole	881.5	25	3	PCB SMT
TT4P4-1960P0-6216	Band pass	4 mm/4 pole	1960	62	1.6	PCB SMT
TT4P4-1880P0-6216	Band pass	4 mm/4 pole	1880	62	1.6	PCB SMT
TT4L4-0836.5P0-2526	Lowpass	4 mm/4 pole	836.5	25	2.6	PCB SMT
TT8N4-0840P0-0440	Bandstop	8 mm/4 pole	840	4	4	PCB SMT
TT6P3-2140P2-6010	Band pass	6 mm/3 pole	2140	60	1	PCB SMT
TT6P10-R1950-T2140	Diplexer	6 mm/5 x 5 pole	R1950/T2140			PCB SMT
TT3P3-1880P0-6022	Band pass	3 mm/3 pole	1880	60	2.5	PCB SMT
TT3P3-1960P0-6022	Band pass	3 mm/3 pole	1960	60	2.5	PCB SMT

GPS (1227.6 MHz/1575.42 MHz/1176 MHz)

Part Number	Filter Type	Size/Poles	Center Frequency (MHz)	Bandwidth (MHz)	Insertion Loss (dB)	Package
TT4P2-1176P4-3020	Band pass	4 mm/2 pole	1176	30	2	PCB SMT
TT3P2-1227P0-2012	Band pass	3 mm/2 pole	1227	20	1.2	PCB SMT
TT3P3-1227.6P1-1030	Band pass	3 mm/3 pole	1227.6	10	3	PCB SMT
TT6P2-1227T-2021	Band pass	6 mm/2 pole	1227	20	2.1	Through-hole
TT6P2-1227F-2008	Band pass	6 mm/2 pole	1227	20	0.8	Flatpack SMT
TT3P2-1575P1-2012	Band pass	3 mm/2 pole	1575	20	1.2	PCB SMT
TT3P3-1575.42P1-1030	Band pass	3 mm/2 pole	1575.42	10	3	PCB SMT
TT4P4-R1227.6-T1575.42	Diplexer	4 mm/2 x 2 pole	R1227.6/T1575.42			PCB SMT
TT4P4-T1575.42-R1227.6	Diplexer	4 mm/2 x 2 pole	T1575.42/R1227.6			PCB SMT
TT6P2-1575T-2020	Band pass	6 mm/2 pole	1575	20	2	Through-hole

PMR (700/800/900 MHz)

Part Number	Filter Type	Size/Poles	Center Frequency (MHz)	Bandwidth (MHz)	Insertion Loss (dB)	Package
TT6P4-0435P0-3019	Band pass	6 mm/4 pole	435	30	1.9	PCB SMT
TT6P2-0808T-1946	Band pass	6 mm/2 pole	808	19	4.6	Through-hole
TT6P4-0770P0-1240	Band pass	6 mm/4 pole	770	12	4	PCB SMT
TT6P5-0765P0-11225	Band pass	6 mm/5 pole	765	11	2.3	PCB SMT
TT2P6-0575P0-7540	Band pass	2 mm/6 pole	575	75	4	PCB SMT
TT4P3-0860P3-1820	Band pass	4 mm/3 pole	860	18	2	PCB SMT
TT6P3-0800P3-1220	Band pass	6 mm/3 pole	800	12	2	PCB SMT
TT6P3-0730P3-1213	Band pass	6 mm/3 pole	730	12	1.3	PCB SMT

WLL/WLAN (3400–3700 MHz)

Part Number	Filter Type	Size/Poles	Center Frequency (MHz)	Bandwidth (MHz)	Insertion Loss (dB)	Package
TT4P3-3430P0-60175	Band pass	4 mm/3 pole	3430	60	1.8	PCB SMT
TT6P3-3450P2-35016	Band pass	6 mm/3 pole	3450	350	1.6	PCB SMT
TT4P3-3462.5P0-2728	Band pass	4 mm/3 pole	3462.5	27	2.8	PCB SMT
TT6P3-3470P0-60175	Band pass	6 mm/3 pole	3470	60	1.8	PCB SMT
TT4P3-3500P2-10020	Band pass	4 mm/3 pole	3500	100	2	PCB SMT
TT4P5-3500P1-20020	Band pass	4 mm/5 pole	3500	200	2	PCB SMT
TT4P3-3520.5P0-4225	Band pass	4 mm/3 pole	3520.5	42	2.5	PCB SMT
TT4P5-3550P1-30020	Band pass	4 mm/5 pole	3550	300	2	PCB SMT
TT6P3-3450P2-35016	Band pass	6 mm/3 pole	3450	350	1.6	PCB SMT
TT6P10-T3420-R3520	Diplexer	6 mm/5x5 pole	T3420/R3520			PCB SMT
TT6P10-T3426-R3550	Diplexer	6 mm/5x5 pole	T3426/R3550			PCB SMT
TT6P10-T3462-R3562	Diplexer	6 mm/5x5 pole	T3462/R3562			PCB SMT
TT6P10-T3475-R3575	Diplexer	6 mm/5x5 pole	T3475/R3575			PCB SMT
TT6P6-T3430-R3530	Diplexer	6 mm/3x3 pole	T3430/R3530			PCB SMT

Available Packages

Skyworks offers filters in a number of standard packages. In addition to SMT, Skyworks offers a flat-pack and through-hole configuration. Mechanical drawings are provided for most of our filters. In addition to our standard offering, Skyworks has the capability and experience to meet many unique footprint layouts and custom packages.

For each of our 2 to 6 pole packages, Skyworks can offer profiles ranging from 2 mm to 6 mm.

2 mm SMT

TT2P2—P—

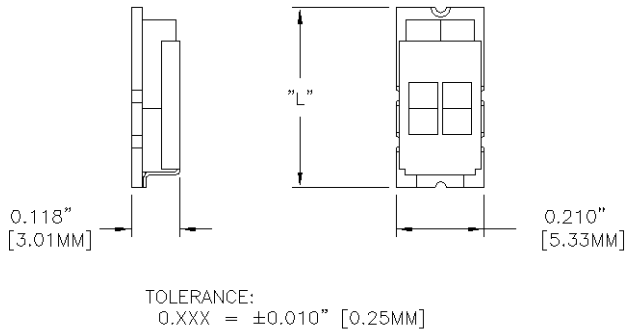

TT2P3—P—

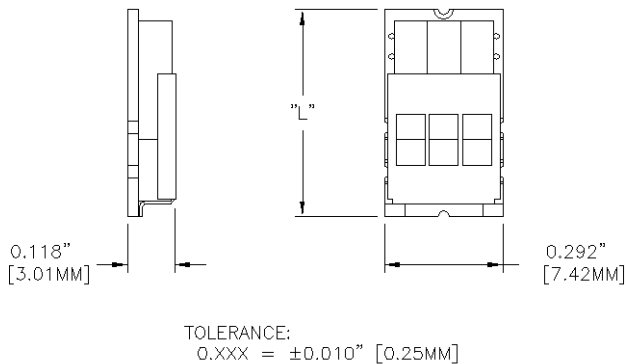

TT2P4—P—

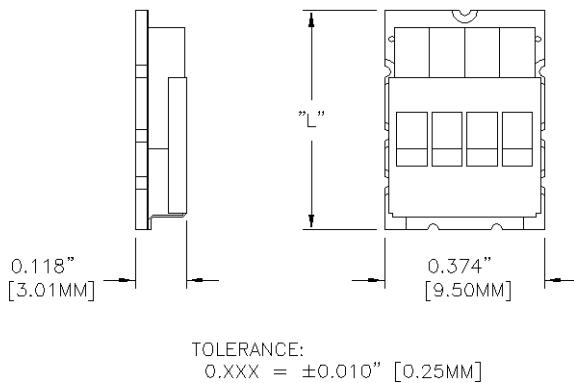

TT2P5—P—

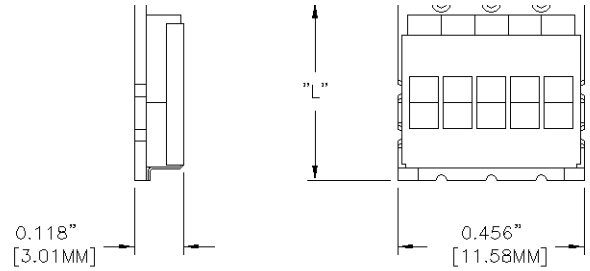

TOLERANCE:
0.XXX = ±0.010" [0.25MM]

TT2P6—P—

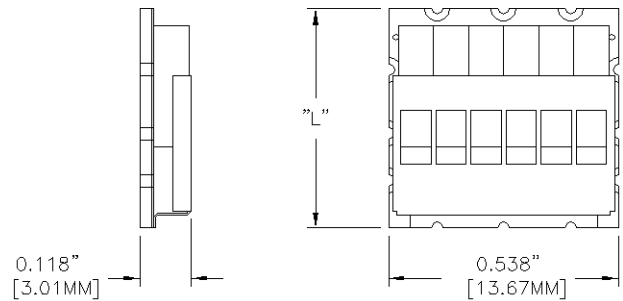

TOLERANCE:
0.XXX = ±0.010" [0.25MM]

SMT Filter Length

Filter	Inches	mm
P1	0.434	11
P2	0.512	13
P3	0.590	15
P4	0.669	17
P5	0.748	19
P6	0.827	21
P7	0.906	23
P0	Custom	Custom

Dimension 'L' will vary in length dependent upon filter's frequency.
All dimensions are in inches.

3 mm SMT

TT3P2—P—

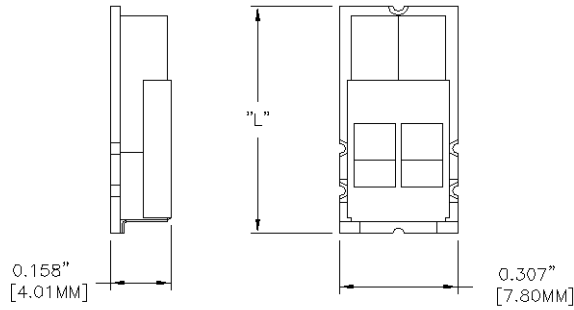

TOLERANCE:
0.XXX = ±0.010" [0.25MM]

TT3P5—P—

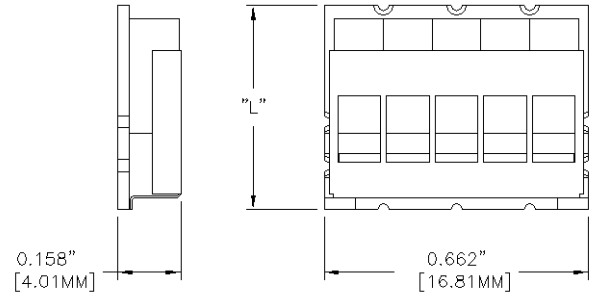

TOLERANCE:
0.XXX = ±0.010" [0.25MM]

TT3P3—P—

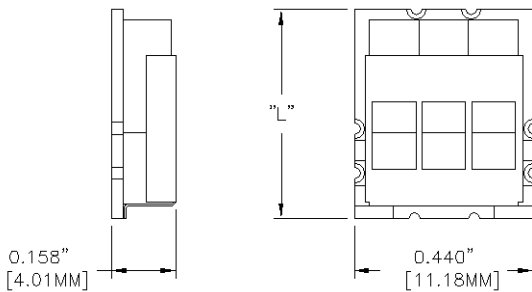

TOLERANCE:
0.XXX = ±0.010" [0.25MM]

TT3P6—P—

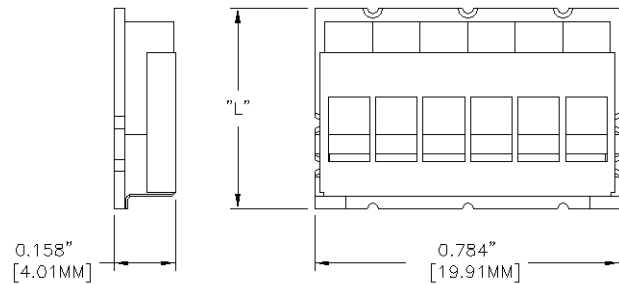

TOLERANCE:
0.XXX = ±0.010" [0.25MM]

TT3P4—P—

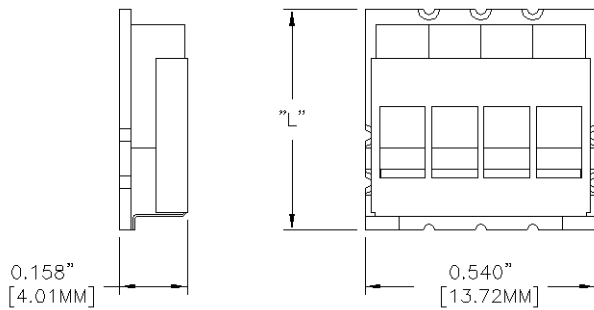

TOLERANCE:
0.XXX = ±0.010" [0.25MM]

SMT Filter Length

Filter	Inches	mm
P1	0.434	11
P2	0.512	13
P3	0.590	15
P4	0.669	17
P5	0.748	19
P6	0.827	21
P7	0.906	23
P0	Custom	Custom

Dimension 'L' will vary in length dependent upon filter's frequency.
All dimensions are in inches.

4 mm SMT

TT4P2—P—

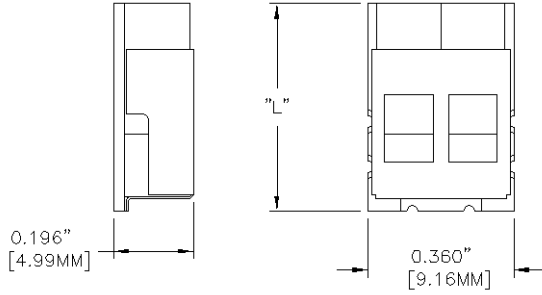

TOLERANCE:
0.XXX = ±0.010" [0.25MM]

TT4P5—P—

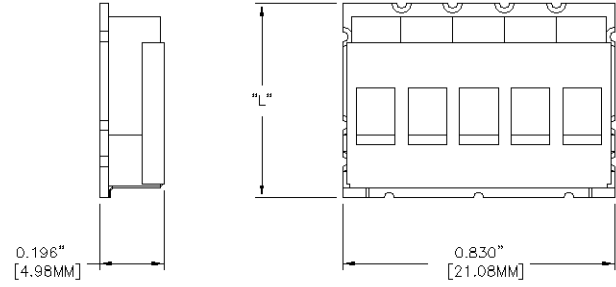

TOLERANCE:
0.XXX = ±0.010" [0.25MM]

TT4P3—P—

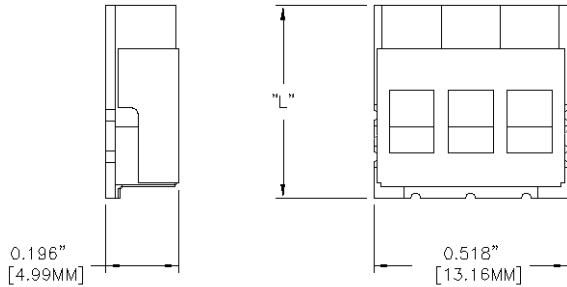

TOLERANCE:
0.XXX = ±0.010" [0.25MM]

TT4P6—P—

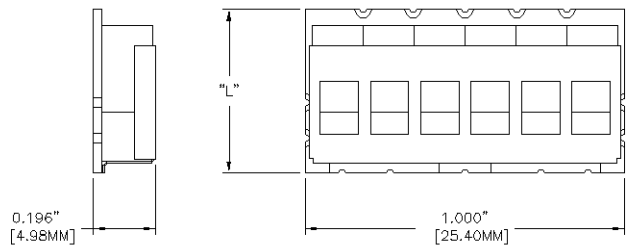

TOLERANCE:
0.XXX = ±0.010" [0.25MM]

TT4P4—P—

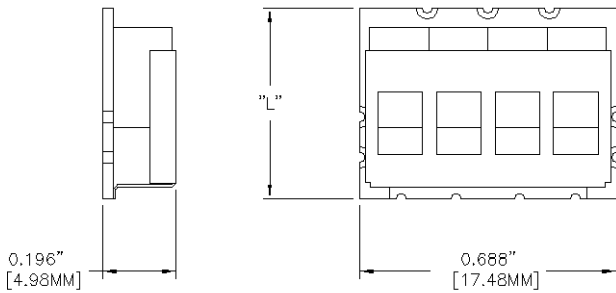

TOLERANCE:
0.XXX = ±0.010" [0.25MM]

SMT Filter Length

Filter	Inches	mm
P1	0.434	11
P2	0.512	13
P3	0.590	15
P4	0.669	17
P5	0.748	19
P6	0.827	21
P7	0.906	23
P0	Custom	Custom

Dimension 'L' will vary in length dependent upon filter's frequency.
All dimensions are in inches.

6 mm SMT

TT6P2—P—

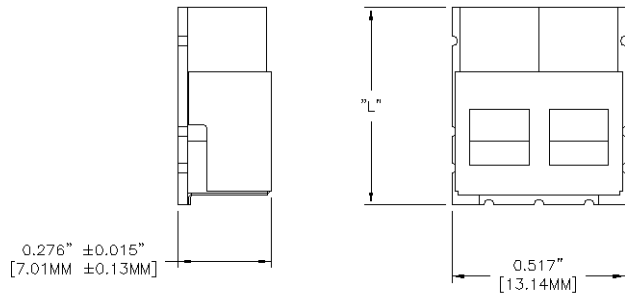

TOLERANCE:
0.XXX = ±0.010" [0.25MM]

TT6P5—P—

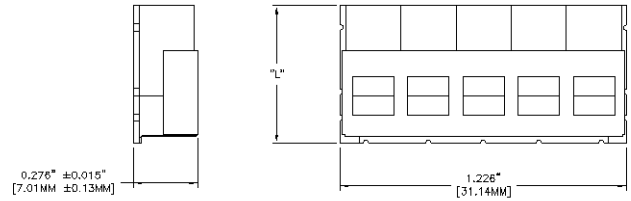

TOLERANCE:
0.XXX = ±0.010" [0.25MM]

TT6P3—P—

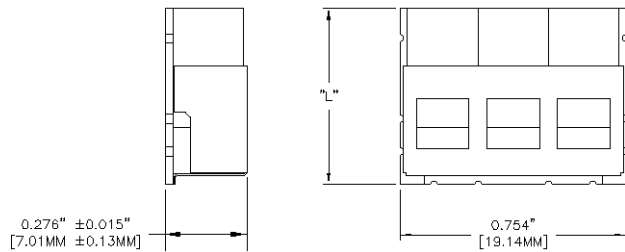

TOLERANCE:
0.XXX = ±0.010" [0.25MM]

TT6P6—P—

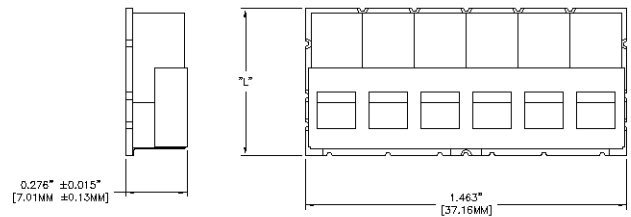

TOLERANCE:
0.XXX = ±0.010" [0.25MM]

TT6P4—P—

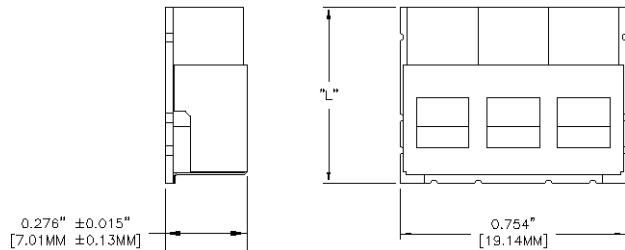

TOLERANCE:
0.XXX = ±0.010" [0.25MM]

SMT Filter Length

Filter	Inches	mm
P1	0.434	11
P2	0.512	13
P3	0.590	15
P4	0.669	17
P5	0.748	19
P6	0.827	21
P7	0.906	23
P0	Custom	Custom

Dimension 'L' will vary in length dependent upon filter's frequency.
All dimensions are in inches.

6 mm Flat Pack (F)

TT6P2—F

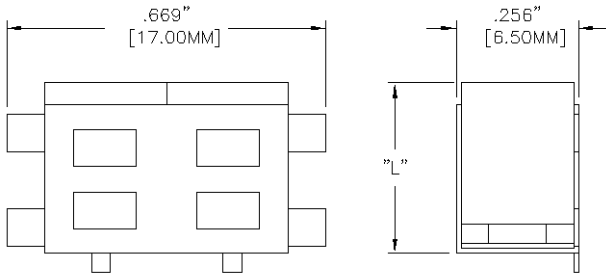

TOLERANCE:
0.XXX = ±0.005" [0.13MM]

TT6P3—F

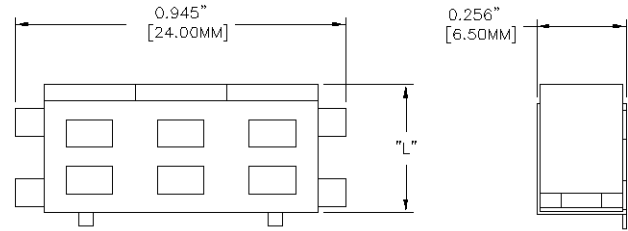

TOLERANCE:
0.XXX = ±0.005" [0.13MM]

6 mm Thru-Hole (T)

TT6P2—T

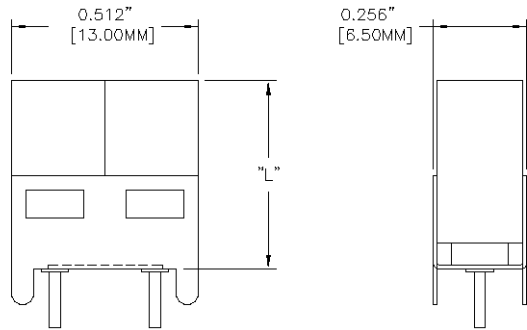

TOLERANCE:
0.XXX = ±0.005" [0.13MM]

TT6P3—T

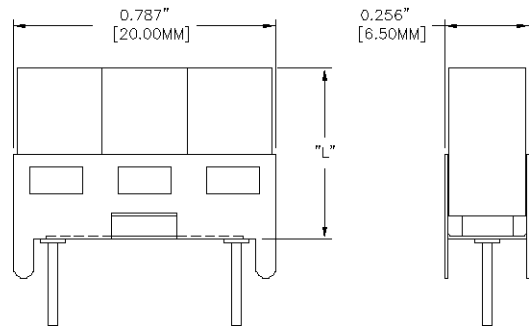

TOLERANCE:
0.XXX = ±0.005" [0.13MM]

Dimension 'L' will vary in length dependent upon filter's frequency.
All dimensions are in inches.

Design Solutions Software

CRAFT Program

Example

Designing a 915 MHz ISM band filter is a typical example of how to use the CRaFT software. Knowing the design parameters in advance helps to narrow down the initial design. Use the following procedures to complete design of this filter.

1. Use the Start button to enter the Programs menu.
2. Select Trans-Tech Design Guides and click on CRaFT.
3. Enter the desired center frequency, 915 MHz, for the filter.
4. Enter the total bandwidth, 25 MHz, necessary for the new design.
5. Use a bandwidth definition of 1 dB.
6. For the example we are going to use a 4 mm package style with 3 poles to the filter.
7. The D9000 material has been preselected for optimum performance. Other material types are included for fine tuning a design.
8. The design is now complete. The part number is listed, TT4P3-0915P3-2530, and the design guide can easily be printed out. In addition a typical plot has been generated to look at attenuation where necessary.

9. As a final aid, there is a list of previously designed filters. If timing is of importance, selecting one from this list removes the time needed for prototyping a new design.
10. Sometimes a filter specification might come up with no solution. In this case, please consult the factory for assistance in the design.
11. After the design has been finalized, the filter can be printed.
12. Click file, choose print data sheet.

Fill out the appropriate information and fax to the number listed on the printed quotation form. At any time, click on Help for details and hints.



Trans-Tech's design software is available by visiting our website; trans-techinc.com or calling us at 301.695.9400.