



# HT1612

## Timer with Dialer Interface

---

### Features

- Operating voltage: 1.2V~1.7V
- Dialing number and conversation time display
- Conversation timer (Max. to 59 mins and 59 secs)
- Operation current: 10 $\mu$ A (Typ.)
- 32768Hz crystal
- 8 or 10 digits LCD display driver, 3V, 1/2 bias, 1/3 duty (8 digits hand-held calculator LCD is used for 8 digits application)
- Built-in dialer interface

### Applications

- Timers
- LCD display drivers
- Telephone display interface
- Instrument display

### General Description

The HT1612 is a CMOS chip designed for dialer interface which drives 8 or 10 digits LCD. Various functions, such as displaying dialing number and conversation time, are provided.

It normally shows blanks. The timer is started to tell users how long the conversation time has been taken when answering a telephone call. After hanging up the telephone, it returns to show blanks immediately. Whenever making a

phone call, the HT1612 receives dialing data from the dialer and displays the phone number from left to right on the LCD. However, if there is no dialing action within 10 seconds, it restarts the timer again. By adding a TIMER key, the HT1612 can provide the timer reset/hold functions (refer to functional description for more details).

Block Diagram

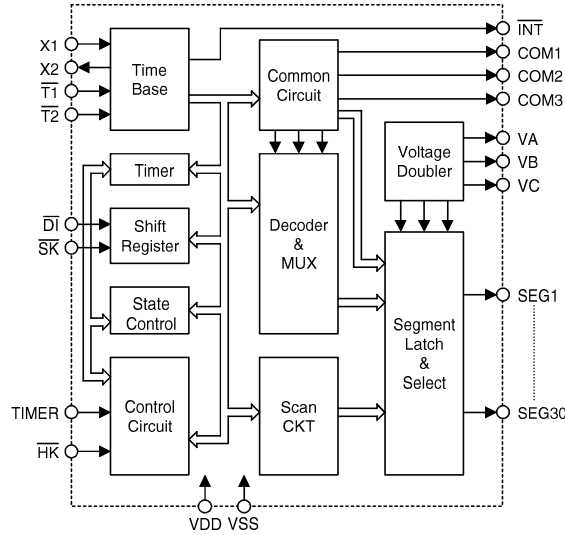

Pad Assignment

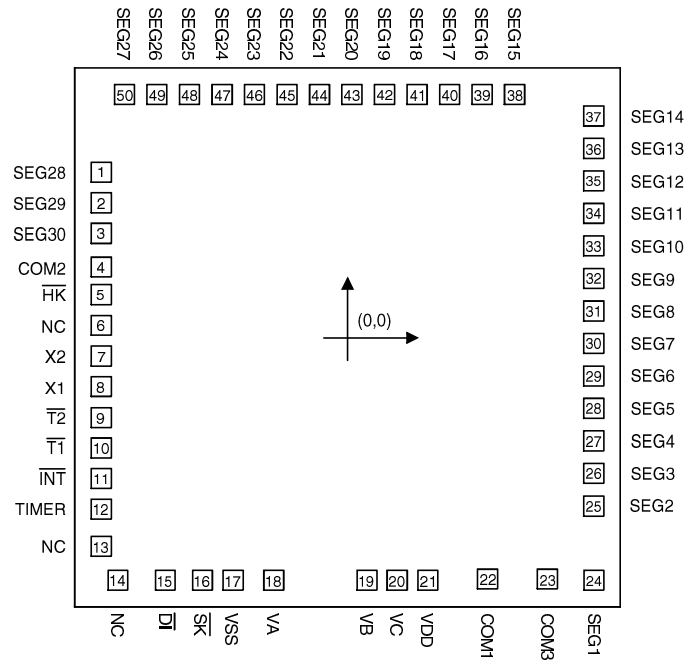

\* The IC substrate should be connected to VDD in the PCB layout artwork.

**Pad Coordinates**

Unit: mil

Pad No.	X	Y	Pad No.	X	Y	Pad No.	X	Y
1	-61.92	41.65	18	-18.66	-60.80	35	61.63	39.46
2	-61.92	33.98	19	4.72	-60.80	36	61.63	47.60
3	-61.92	26.30	20	12.36	-60.80	37	61.63	55.79
4	-61.92	17.85	21	20	-60.80	38	41.78	61.14
5	-61.92	10.95	22	34.98	-60.46	39	33.62	61.14
6	-61.92	3.17	23	50.02	-60.46	40	25.46	61.14
7	-61.92	-4.53	24	61.67	-60.80	41	17.30	61.14
8	-61.92	-12.22	25	61.63	-42.18	42	9.14	61.14
9	-61.92	-19.96	26	61.63	-33.98	43	0.98	61.14
10	-61.92	-27.60	27	61.63	-25.82	44	-7.18	61.14
11	-61.92	-35.26	28	61.63	-17.66	45	-15.34	61.14
12	-61.92	-42.95	29	61.63	-9.50	46	-23.50	61.14
13	-61.92	-52.26	38	61.63	-1.34	47	-31.66	61.14
14	-57.80	-60.80	39	61.63	6.80	48	-39.82	61.14
15	-45.90	-60.80	31	61.63	14.98	49	-47.98	61.14
16	-36.50	-60.80	32	61.63	23.14	50	-56.14	61.14
17	-28.86	-60.80	33	61.63	31.30			

**Pad Description**

Pad Name	I/O	Internal Connection	Description
SEG1~SEG30	O	CMOS OUT	LCD segment signal output pads
COM1~COM3	O	CMOS OUT	LCD common signal output pads
$\overline{HK}$	I	CMOS IN Pull-High	Hook switch detector input Active low
X2	O	OSCILLATOR	32768Hz crystal oscillator output
X1	I	OSCILLATOR	32768Hz crystal oscillator input
$\overline{T2}$	I	CMOS IN Pull-High	Test pad (connected to VSS for production test)
$\overline{T1}$	I	CMOS IN Pull-High	Test pad (connected to VSS for production test)
$\overline{INT}$	O	NMOS OUT	Interrupt output, 8 or 16Hz by mask option
TIMER	I	CMOS IN Pull-Low	Timer reset and start/hold toggle control input pad

Pad Name	I/O	Internal Connection	Description
$\overline{DI}$	I	CMOS IN Pull-High	Serial data input pad (connected to the dialer) Data should be valid at the falling edge of $\overline{SK}$
$\overline{SK}$	I	CMOS IN Pull-High	Clock input pad (connected to the dialer)
VSS	I	—	Negative power supply (GND)
VA	O	CMOS OUT	Voltage doubler, connected to the external capacitor
VB	O	CMOS OUT	Voltage doubler, connected to the external capacitor
VC	O	CMOS OUT	Voltage doubler, connected to the external capacitor
VDD	I	—	Positive power supply
NC	—	—	No connection

**Approximate internal connection circuit**

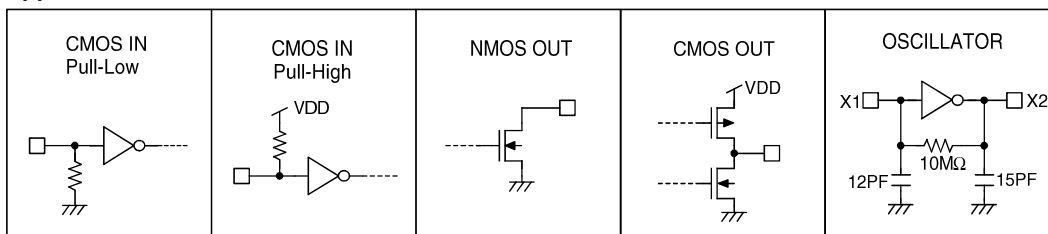

**Absolute Maximum Ratings**

Supply Voltage ..... -0.3V to 5V      Storage Temperature ..... -50°C to 125°C  
 Input Voltage .....  $V_{SS}-0.3$  to  $V_{DD}+0.3$       Operating Temperature ..... -20°C to 75°C

**Electrical Characteristics**

 (F<sub>OSC</sub>=32768Hz, T<sub>a</sub>=25°C)

Symbol	Parameter	Test Condition		Min.	Typ.	Max.	Unit
		V <sub>DD</sub>	Condition				
V <sub>DD</sub>	Operating Voltage	—	—	1.2	1.5	1.7	V
V <sub>IL</sub>	Input Low Voltage	1.2V~1.7V	—	V <sub>SS</sub>	—	0.2V <sub>DD</sub>	V
V <sub>IH</sub>	Input High Voltage	1.2V~1.7V	—	0.8V <sub>DD</sub>	—	V <sub>DD</sub>	V
I <sub>STB</sub>	Stand-by Current	1.5V	V <sub>HK</sub> =Floating (or V <sub>DD</sub> )	—	0.1	1	μA
I <sub>DD</sub>	Operating Current	1.5V	No load	—	10	30	μA
I <sub>OL</sub>	Output Sink Current of INT	1.5V	V <sub>O</sub> =0.3V	500	1000	—	μA
T <sub>A</sub>	Data Setup Time	1.5V	—	1	—	—	μs
T <sub>B</sub>	Data Hold On Time	1.5V	—	2	—	—	μs
T <sub>C</sub>	Inter Digit Time	1.5V	—	5	—	—	μs
T <sub>DB</sub>	Debounce Time (HK, TMIER)	1.5V	—	—	31.25	—	ms
R <sub>HI</sub>	Pull-High Resistance (HK, DI, SK)	1.5V	V <sub>IN</sub> =0V	—	1	—	MΩ
R <sub>LO</sub>	Pull-Low Resistance (TIMER)	1.5V	V <sub>TIMER</sub> =1.5V	—	5	—	MΩ
F <sub>OSC</sub>	System Frequency	1.5V	Crystal=32768Hz	—	32768	—	Hz

Functional Description

Operational flow chart

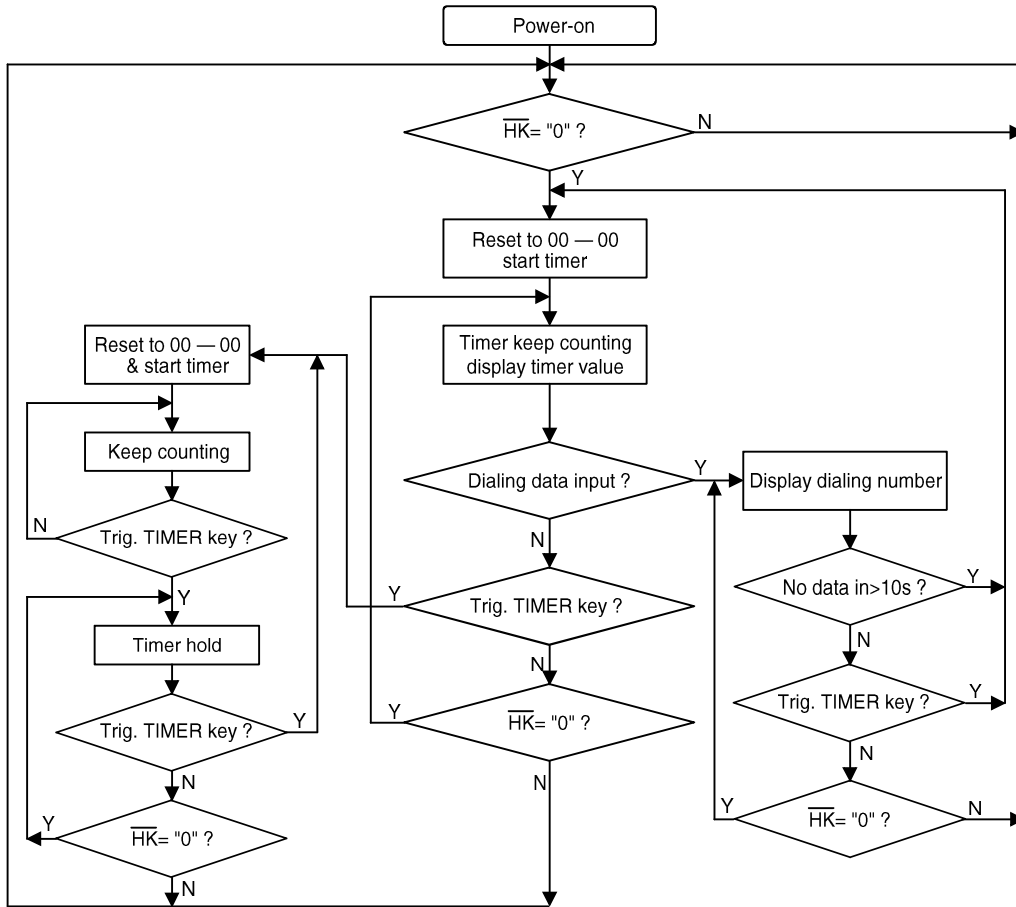

About On-Hook & Off-Hook

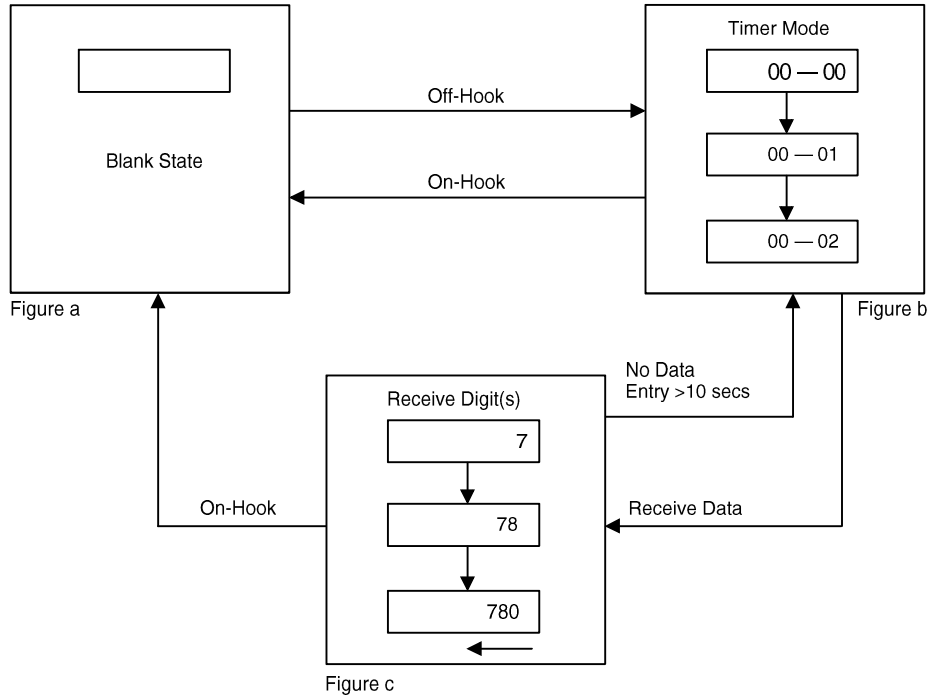

- Note:
1. Figure a displays blanks.
  2. Figure b illustrates a timer mode caused by Off-Hook; timer is reset and starts to count the conversation time.
  3. In Figure c. The dialing data are received and displayed on the LCD from left to right after Off-Hook. When the entry interval is over 10 seconds, it resets the timer and starts to count.

**TIMER key function**

In the conversation timer mode, the TIMER key can reset or hold the timer.

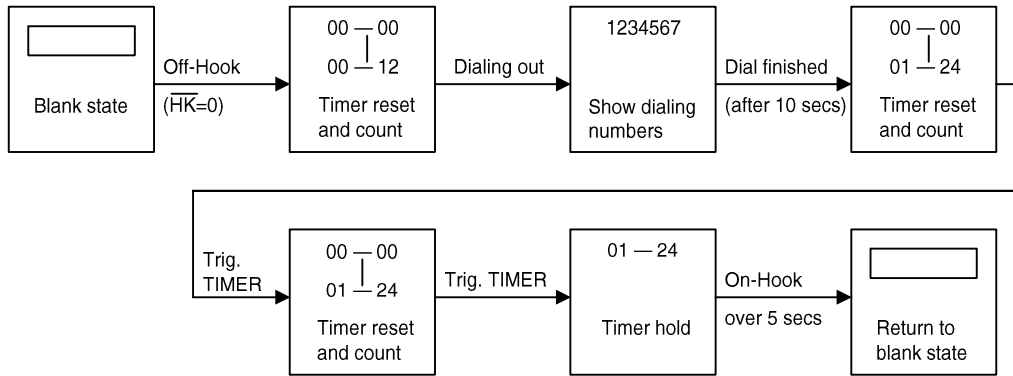

**Data & Timing**

- Data latch timing

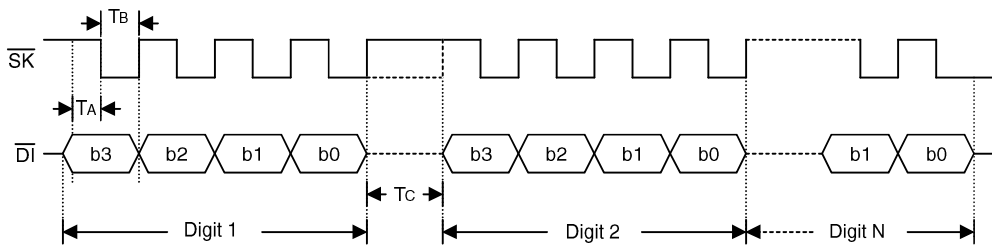

- For instrument or  $\mu$ C application

The HT1612 is also capable of displaying the BCD data which are generated from instruments or  $\mu$ C system. The corresponding data and timing are shown in Data latch timing. Before the data are transmitted to the HT1612, the HK pin should be pull-low or keeps low always. Then, the HT1612 is ready to receive the data. At the falling edge of the clock the data are shifted to the IC. After the whole data are sent to the HT1612, the SK pin is set low to avoid switching to the timer mode.



- For telephone application

The HT1612 is designed to display telephone numbers which are derived from the HT92XXX series telephone dialers. The corresponding data are illustrated in the following table.

Key-In	Data Code				Display
	b3	b2	b1	b0	
Blank	0	0	0	0	Blank
1	0	0	0	1	1
2	0	0	1	0	2
3	0	0	1	1	3
4	0	1	0	0	4
5	0	1	0	1	5
6	0	1	1	0	6
7	0	1	1	1	7
8	1	0	0	0	8
9	1	0	0	1	9
0	1	0	1	0	0
*	1	1	0	1	*
#	1	1	0	0	#
F	1	0	1	1	F
P	1	1	1	0	P
	1	1	1	1	-

Application Circuits

For telephone interfacing

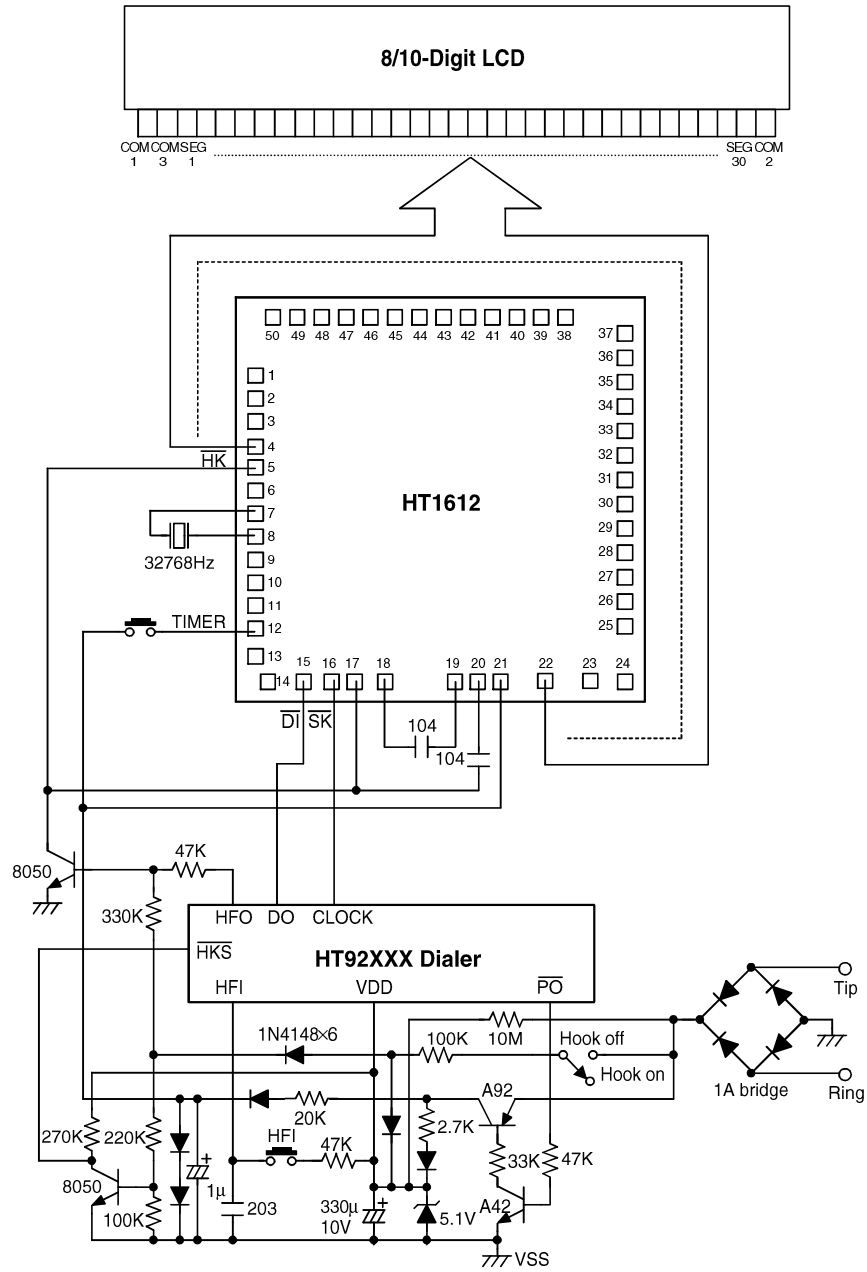

\* The IC substrate should be connected to VDD in the PCB layout artwork.



For instrument or  $\mu$ C use (3V supply)

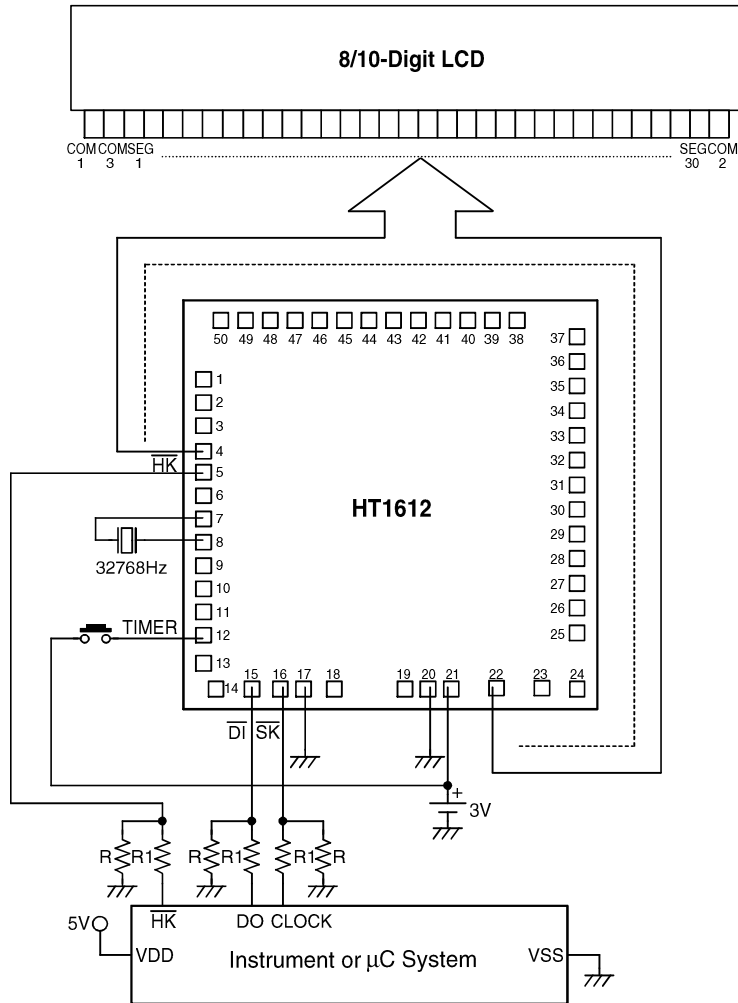

\* The IC substrate should be connected to VDD in the PCB layout artwork.

- Note:
1. To drive the  $\overline{SK}$ ,  $\overline{DI}$ , and  $\overline{HK}$  pin, an open drain NMOS output structure is recommended.
  2. To drive the  $\overline{SK}$ ,  $\overline{DI}$  and  $\overline{HK}$  pin with CMOS output structure, a voltage divider is needed (R=20K, R1=10K).

**LCD Connection**

For 8-digit application

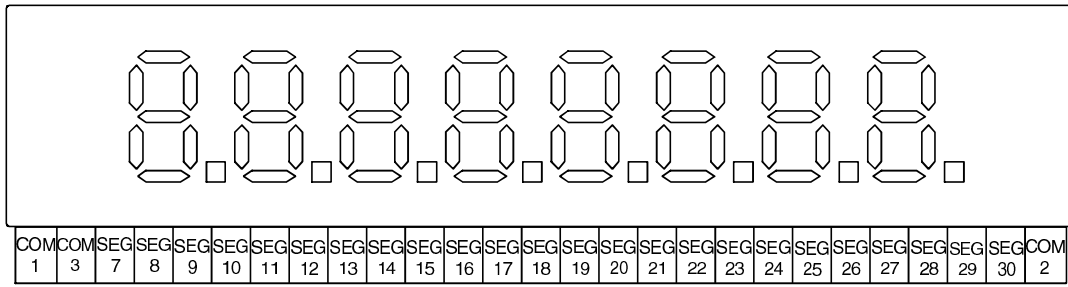

**Segment Electrode Side**

LCD driving system 1/2 bias, 1/3 duty, 3V.

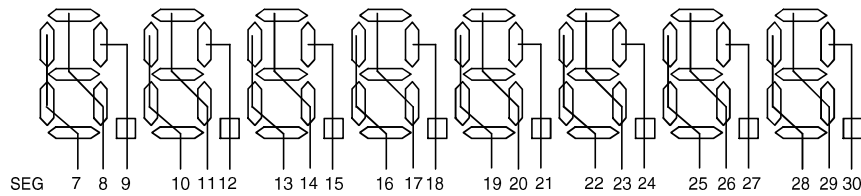

**Common Electrode Side**

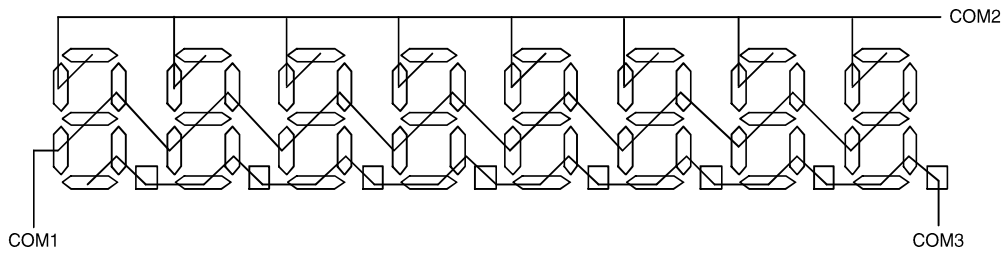

**LCD Connection**

For 10-digit application

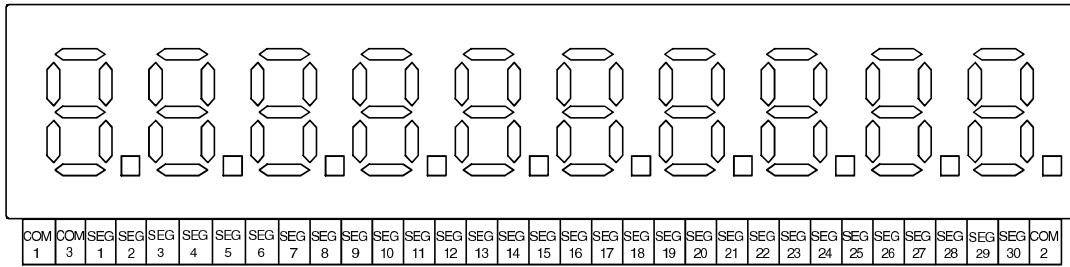

**Segment Electrode Side**

\* LCD driving system 1/2 bias, 1/3 duty, 3V.

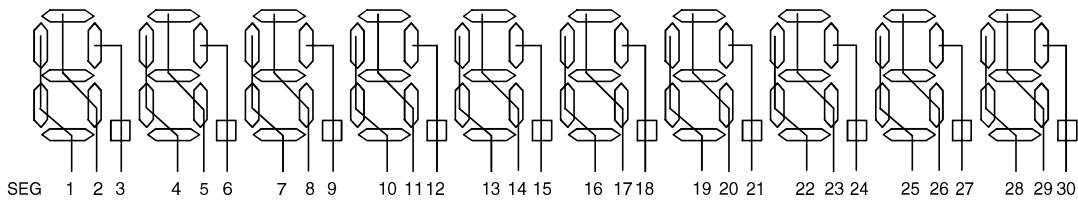

**Common Electrode Side**

