



E-Series Surface Mount Mixer

1850 – 1980 MHz

Features

- LO Power +13 dBm
- +22dB Compression Point
- Surface Mount
- +32dBm IIP3
- Up and Down converting

Description

M/A Com's EFM-1900 uses a novel, patent pending design to achieve very high linearity at low LO drive levels. Typically IP3 performance is +32dBm with an LO drive level of just +13dBm. The mixer combines PHEMT devices and carefully matched transformers in a surface mount package which can be used for both up and down converting. It is ideally suited for wireless applications where high linearity is required. Parts are

Schematic

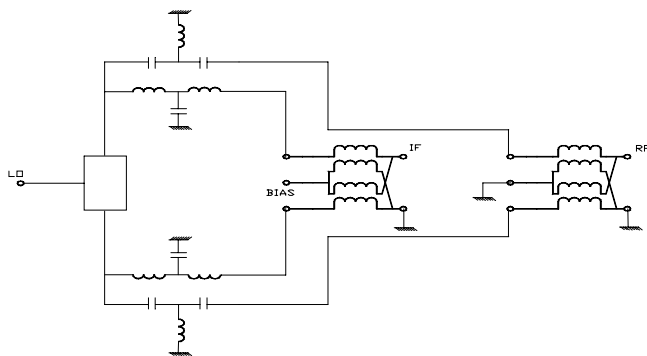

SM-106 Package

Note: Non Hermetic Package, Metal Cover.

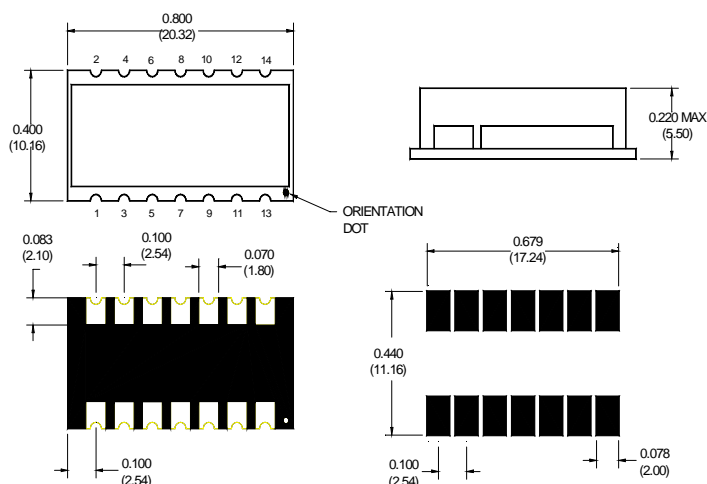

Electrical Specifications

Parameter	Units	Minimum	Typical	Maximum
Frequency Range	RF 1850 -1980 MHz LO 1350 - 1880 MHz IF 100 - 500 MHz DC bias 3V ± 0.3V	—	—	—
Conversion Loss	1850 - 1980 MHz	dB	7.5	9.5
L - R Isolation	1350 - 1880 MHz	dB	15.0	19.0
L - I Isolation	1350 - 1880 MHz	dB	22.0	28.0
R - I Isolation	1350 - 1880 MHz	dB	25.0	35.0
LO VSWR	1350 - 1880 MHz	—	3.8	—
RF VSWR	1850 - 1980 MHz	—	3.5	—
IF VSWR	100 - 500 MHz	—	1.8	—
Input IP3		dBm	28.0	32.0
Input 1dB Compression		dBm	—	+22.0

V1.00 S 1457 B

Absolute Maximum Ratings

Parameter	Absolute Maximum
RF Power	200 mW
Peak IF Current	40 mA
Storage Temperature	-40°C to +85°C
Operating Temperature	-40°C to +85°C
ESD Rating	Zero

Pin Configuration

Function	Pin No.
LO	9
RF	2
IF	14
BIAS	13
Ground	1,3,4,5,6,7,8,10,11,12
Unconnected	—

Typical Performance

Conversion Loss

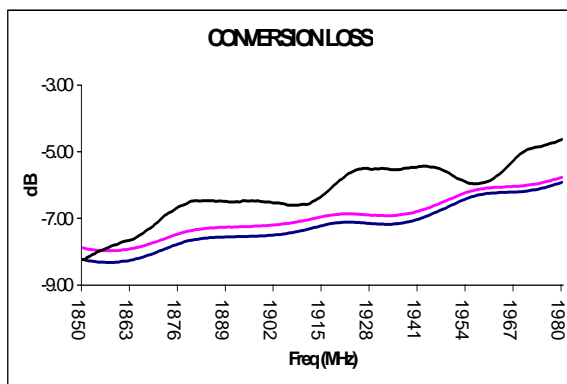

L - R Isolation

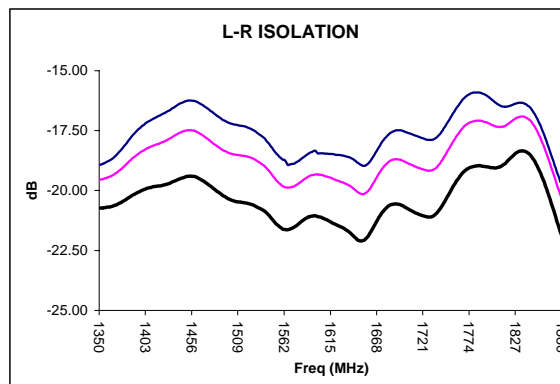

L-I Isolation

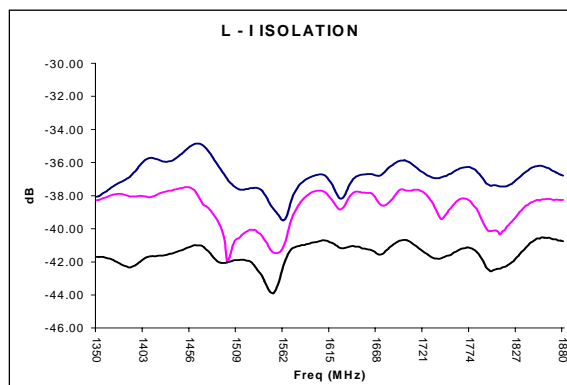

Input IP3

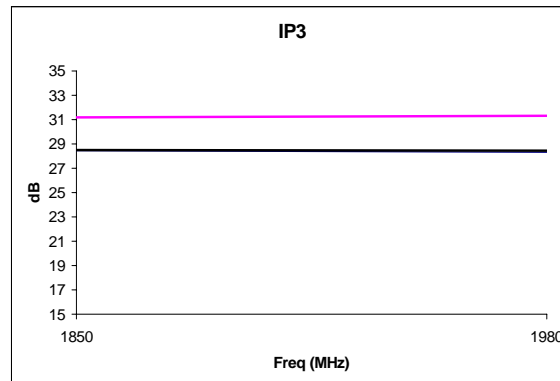

1dB Compression Point

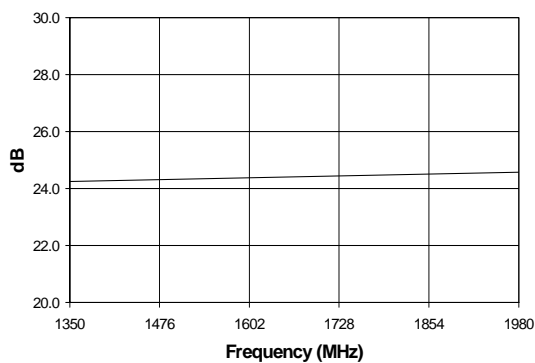

Spurious Table: 1850MHz

(In dBc below IF, assuming down conversion)

		nf _{LO} - mf _{RF}				
RF	0	X	16	8	16	16
	1	26	0	42	47	58
	2	67	77	55	77	77
	(n)	3	77	77	77	77
		4	77	77	77	77
		0	1	2	3	4

LO (m)

RF = 1850 MHz, 0dBm
 LO = 1750 MHz, +13dBm
 IF = 100 MHz

Spurious Table: 1850MHz

(In dBc below IF, assuming down conversion)

		nf _{LO} - mf _{RF}				
RF	0	X	13	29	27	25
	1	27	0	17	58	45
	2	58	77	53	49	74
	(n)	3	77	77	77	77
		4	77	77	77	77
		0	1	2	3	4

LO (m)

RF = 1850 MHz, 0dBm
 LO = 1350 MHz, +13dBm
 IF = 500 MHz

Spurious Table: 1980MHz

(In dBc below IF, assuming down conversion)

		nf _{LO} - mf _{RF}				
RF	0	X	9	25	34	17
	1	30	0	55	62	60
	2	77	69	66	74	77
	(n)	3	77	77	77	77
		4	77	77	77	77
		0	1	2	3	4

LO (m)

RF = 1980 MHz, 0dBm
 LO = 1880 MHz, +13dBm
 IF = 100 MHz

Spurious Table: 1980MHz

(In dBc below IF, assuming down conversion)

		nf _{LO} - mf _{RF}				
RF	0	X	12	18	14	25
	1	30	0	21	59	58
	2	70	77	66	60	75
	(n)	3	77	77	77	77
		4	77	77	77	77
		0	1	2	3	4

LO (m)

RF = 1980 MHz, 0dBm
 LO = 1480 MHz, +13dBm
 IF = 500 MHz