

ASSP For Power Management Applications (Mobile Phones)

Power Management IC for GSM Mobile Phone

MB3891

■ DESCRIPTION

MB3891 is intended to be used in future GSM-phones, Dual Band phones and Dual Mode phones. It contains all the necessary functions to support all Digital, Analog and RF blocks in these phones. A Charge-pump including a Logic Level Translation circuit is built in to support SIM-card (SmartCard) of both 3 and 5 Volt technology. The circuit contains a charger for a rechargeable Lithium coin cell of a Real Time Clock.

A complex control circuit is built in to generate main reset and to turn on and off the different LDO's.

■ FEATURES

- Supply voltage range : 3 V to 5.5 V
- Low power consumption current during standby : 400 μ A (MAX)
- 6-channel low-saturation voltage type series regulator
 - : 2.1 V/2 channels, 2.8 V/3 channels, 2.5 V/2.8 V switch
- Error prevention function during Low voltage
- Power on reset function
- 3 V/5 V SW for SIM-Card
- SIM interface function
- Backflow prevention function for Battery-Backup
- Temperature prevention function

■ PACKAGE

64-pin plastic LQFP

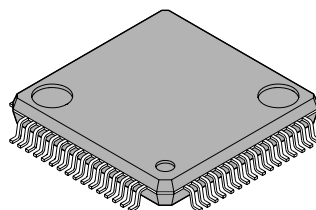

(FPT-64P-M03)

PIN ASSIGNMENT

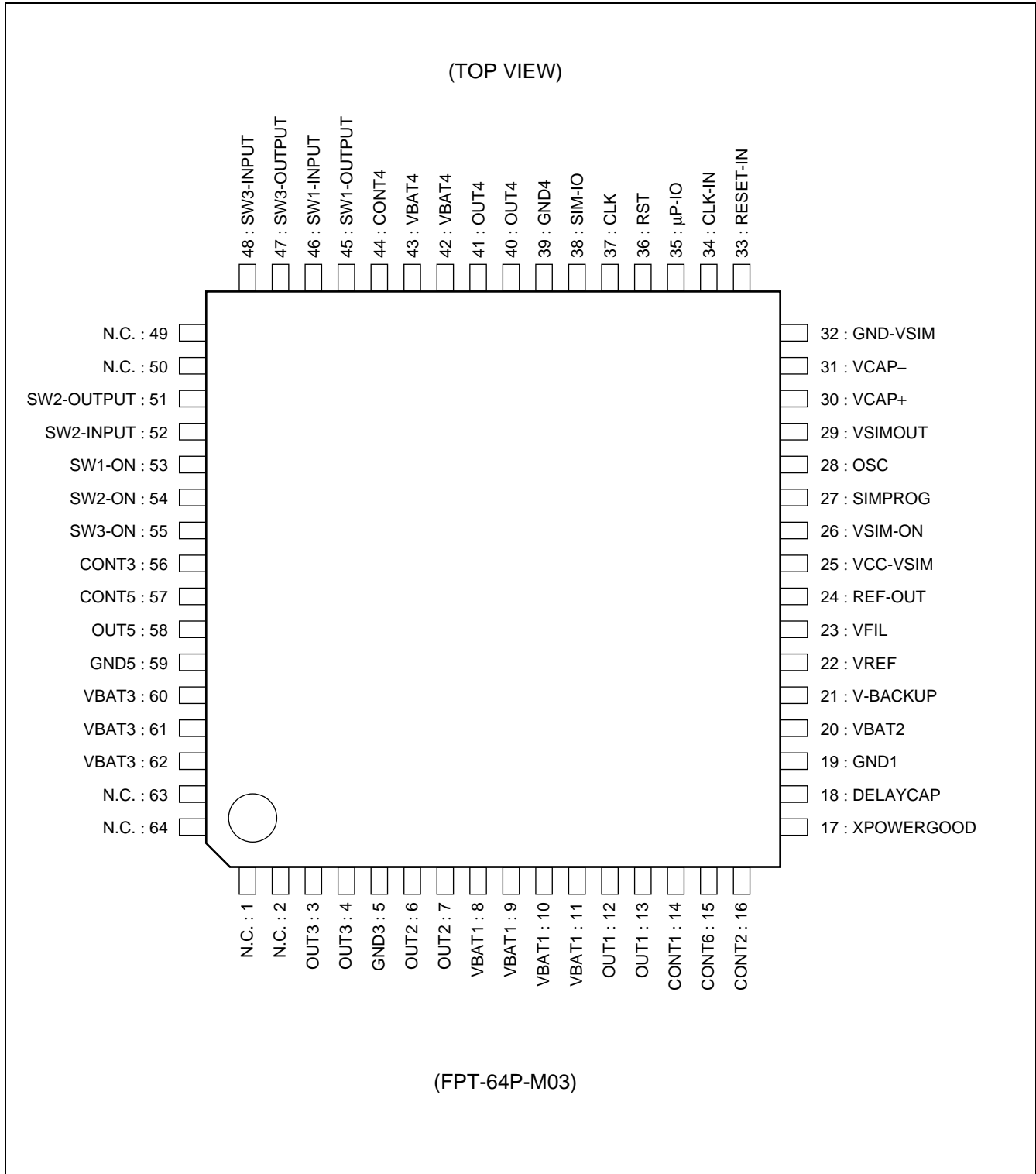

■ PIN DESCRIPTION

Pin No.	Symbol	I/O	Descriptions
1, 2	N.C.	—	Non connection.
3, 4	OUT3	O	LDO3 output pin.
5	GND3	—	LDO3 ground pin.
6, 7	OUT2	O	LDO2 output pin.
8, 9, 10, 11	VBAT1	—	Battery voltage input pin for LDO1 and LDO2.
12, 13	OUT1	O	LDO1 output pin.
14	CONT1	I	Power on input from keypad (Active low, Pulled up to VBAT2).
15	CONT6	I	“CONT6” input from digital system μ P (Active high).
16	CONT2	I	External accessory supply voltage Enable (Active high).
17	XPOWERGOOD	O	Generates the main reset. (Active low, when OUT1 is out of regulation).
18	DELAYCAP	—	Timing capacitor for XPOWERGOOD delay.
19	GND1	—	LDO1, LDO2, V-BACKUP, Reference and System ground pin.
20	VBAT2	—	Battery voltage input pin for both UVLO's, Reference and V-BACKUP LDO.
21	V-BACKUP	O	Supply voltage for Charger for rechargeable Lithium coin cell.
22	VREF	O	Supply voltage for Reference.
23	VFIL	O	Reference voltage Filter.
24	REF-OUT	O	Reference output voltage (Present when BACKUP UVLO is high).
25	VCC-VSIM	—	Input voltage for charge pump. (Supplied by VBAT1).
26	VSIM-ON	I	VSIM supply Enable (Active high).
27	SIMPROG	I	VSIM programming: Low = 3 V SIM, High = 5 V SIM.
28	OSC	—	Oscillator output pin.
29	VSIMOUT	O	Supply voltage for 3 or 5 V SIM-Card (SmartCard).
30	VCAP+	—	Positive side of boost capacitor.
31	VCAP-	—	Negative side of boost capacitor.
32	GND-VSIM	—	3 or 5 V SIM-Card (SmartCard) ground pin.
33	RESET-IN	I	Non level shifted SIM reset (μ P side).
34	CLK-IN	I	Non level shifted clock (μ P side).
35	μ P-IO	I/O	Non level shifted bi-directional data input/output (μ P side).
36	RST	O	Level shifted SIM reset (SmartCard side).
37	CLK	O	Level shifted SIM clock (SmartCard side).
38	SIM-IO	I/O	Level shifted bi-directional SIM data input/output (SmartCard side).
39	GND4	—	LDO4 ground pin.
40, 41	OUT4	O	LDO4 output pin.

(Continued)

MB3891

(Continued)

Pin No.	Symbol	I/O	Descriptions
42, 43	VBAT4	—	Supply voltage for LDO4.
44	CONT4	I	OUT4 output voltage selection (“L”=2.8 V, “H”=2.5 V).
45	SW1-OUTPUT	O	Output of general purpose switch number 1 (Drain).
46	SW1-INPUT	I	Input of general purpose switch number 1 (Source).
47	SW3-OUTPUT	O	Output of general purpose switch number 3 (Drain).
48	SW3-INPUT	I	Input of general purpose switch number 3 (Source).
49, 50	N.C.	—	Non connection.
51	SW2-OUTPUT	O	Output of general purpose switch number 2 (Drain).
52	SW2-INPUT	I	Input of general purpose switch number 2 (Source).
53	SW1-ON	I	General purpose switch number 1 Enable (Active high).
54	SW2-ON	I	General purpose switch number 2 Enable (Active high).
55	SW3-ON	I	General purpose switch number 3 Enable (Active high).
56	CONT3	I	OUT3 and OUT4 supply voltage Enable (Active high).
57	CONT5	I	OUT5 supply voltage Enable (Active high).
58	OUT5	O	Output terminal of LDO5.
59	GND5	—	LDO5 ground pin.
60, 61, 62	VBAT3	—	Supply voltage for LDO and LDO5.
63, 64	N.C.	—	Non connection.

■ BLOCK DIAGRAM

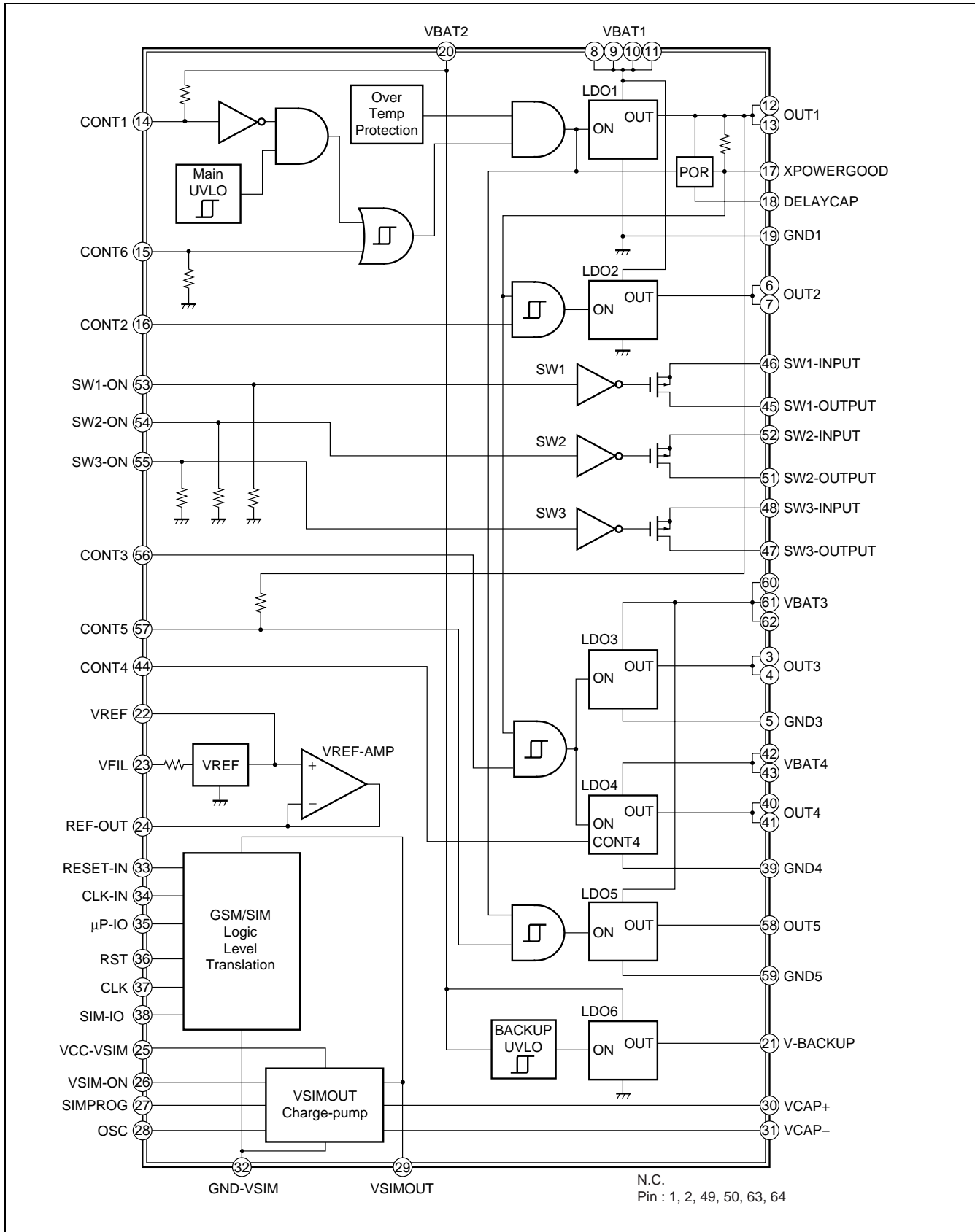

■ ABSOLUTE MAXIMUM RATINGS

Parameter	Symbol	Conditions	Rating		Unit
			Min.	Max.	
Power supply voltage	VBAT	—	-0.3	7	V
	VCC-VSIM	—	-0.3	7	V
LDO regulator	I _o	OUT1 pin	—	120	mA
	I _o	OUT2 pin	—	50	mA
	I _o	OUT3 pin	—	100	mA
	I _o	OUT4 pin	—	100	mA
	I _o	OUT5 pin	—	50	mA
VSIMOUT chargepump	I _o	VSIMOUT pin	—	10	mA
Power dissipation	P _D	T _a ≤ +25 °C	—	800*	mW
Storage temperature	T _{stg}	—	-55	+125	°C

* : The packages are mounted on the dual-sided epoxy board(10 cm × 10 cm)

WARNING: Semiconductor devices can be permanently damaged by application of stress (voltage, current, temperature, etc.) in excess of absolute maximum ratings. Do not exceed these ratings.

■ RECOMMENDED OPERATING CONDITIONS

Parameter	Symbol	Conditions	Value			Unit
			Min.	Typ.	Max.	
Power supply voltage	VBAT	—	3.0	3.6	5.5	V
	VCC-VSIM	—	3.0	3.6	5.5	V
LDO capacitor guarantee value	C _o	OUT1 to OUT5, V-BACKUP pin	0.8	1.0	—	μF
REF-OUT capacitor guarantee value	C _o	REF-OUT pin	—	0.027	—	μF
VSIMOUT capacitor guarantee value	C _o	VSIMOUT pin	—	10	—	μF
Operating ambient temperature	T _a	—	-20	+25	+85	°C

WARNING: The recommended operating conditions are required in order to ensure the normal operation of the semiconductor device. All of the device's electrical characteristics are warranted when the device is operated within these ranges.

Always use semiconductor devices within their recommended operating condition ranges. Operation outside these ranges may adversely affect reliability and could result in device failure.

No warranty is made with respect to uses, operating conditions, or combinations not represented on the data sheet. Users considering application outside the listed conditions are advised to contact their FUJITSU representatives beforehand.

■ ELECTRICAL CHARACTERISTICS

(Ta = +25 °C, VBAT1 to VBAT4 = VCC-VSIM = 3.6 V)

Parameter	Symbol	Pin No.	Conditions	Value			Unit	
				Min.	Typ.	Max.		
General	Shutdown supply current	IBAT1	8, 9, 10, 11, 20, 42, 43, 60, 61, 62	UVLO = "L", BACKUP UVLO = "L"	—	—	80	μA
		IBAT2	8, 9, 10, 11, 20, 42, 43, 60, 61, 62	UVLO = "L", BACKUP UVLO = "H"	—	—	160	μA
	Standby supply current	IBAT3	8, 9, 10, 11, 20, 42, 43, 60, 61, 62	All circuit's = On (No load)	—	—	400	μA
	Operating ground current	IGND	4, 5, 19, 32, 59	All circuit's -VSIM = On Max. load on all regulators	—	—	10	mA
	UVLO threshold voltage	VTHH	8, 9, 10, 11, 20, 42, 43, 60, 61, 62	OUT1 = ON	2.980	3.080	3.180	V
		VTHL	8, 9, 10, 11, 20, 42, 43, 60, 61, 62	OUT1 = OFF	2.780	2.880	2.980	V
	BACKUP UVLO threshold voltage	VTHH	8, 9, 10, 11, 20, 42, 43, 60, 61, 62	V-BACKUP = ON	2.980	3.080	3.180	V
		VTHL	8, 9, 10, 11, 20, 42, 43, 60, 61, 62	V-BACKUP = OFF	2.580	2.680	2.780	V
	Input voltage	V _{IH}	16, 56, 57	—	0.7 × OUT1	—	OUT1	V
		V _{IL}	16, 56, 57	—	0	—	0.3 × OUT1	V
		V _{IH}	14, 15, 44	—	0.7 × VBAT	—	VBAT	V
		V _{IL}	14, 15, 44	—	0	—	0.3 × VBAT	V
		V _{IH}	26, 27	—	0.7 × VCC-VSIM	—	VCC-VSIM	V
		V _{IL}	26, 27	—	0	—	0.3 × VCC-VSIM	V
	Pull-up resistor	R _{PU}	17	—	—	15*	—	kΩ
		R _{PU}	14, 57	—	—	200*	—	kΩ
	Pull-down resistor	R _{PD}	15, 53, 54, 55	—	—	200*	—	kΩ

* : Standard design value

(Continued)

(Ta = +25 °C, VBAT1 to VBAT4 = VCC-VSIM = 3.6 V)

Parameter	Symbol	Pin No.	Conditions	Value			Unit	
				Min.	Typ.	Max.		
LDO1 (OUT1)	Output voltage	V _O	12, 13	-50 μA > OUT1 > -120 mA	2.000	2.100	2.200	V
	Line regulation	Line	12, 13	3.1 V < VBAT1 < 5.5 V	—	—	10	mV
	Load regulation	Load	12, 13	-50 μA > OUT1 > -120 mA	—	—	30	mV
	Ripple rejection ΔVBAT1/ΔOUT1	R.R	12, 13	f = 217 Hz	45	—	—	dB
	Dropout voltage	V _{DO}	12, 13	OUT1 = -120 mA	—	—	500	mV
	GND current at low load	I _{GND}	19	OUT1 > -1 mA	—	—	30	μA
	GND current at max. load	I _{GND}	19	OUT1 = -120 mA	—	—	2	mA
	Output noise volt. (RMS)	V _{NOVL}	12, 13	f = 10 Hz to 1 MHz, OUT1 = 1 μF	—	—	500	μV
XPOWER- GOOD (RESET)	Output voltage	V _{OH}	17	—	0.8 × OUT1	—	OUT1	V
		V _{OL}	17	—	0	—	0.1 × OUT1	V
	Hold time	T _{XPG}	17	DELAYCAP = 0.033 μF	10	25	40	ms
LDO2 (OUT2)	Output voltage	V _O	6, 7	-50 μA > OUT2 > -50 mA	2.700	2.800	2.900	V
	Line regulation	Line	6, 7	3.1 V < VBAT1 < 5.5 V	—	—	10	mV
	Load regulation	Load	6, 7	-50 μA > OUT2 > -50 mA	—	—	30	mV
	Ripple rejection ΔVBAT1/ΔOUT2	R.R	6, 7	f = 217 Hz	45	—	—	dB
	Dropout voltage	V _{DO}	6, 7	OUT2 = -50 mA	—	—	250	mV
	GND current at low load	I _{GND}	19	OUT2 > -1 mA	—	—	30	μA
	GND current at max. load	I _{GND}	19	OUT2 = -50 mA	—	—	1	mA
	Output noise volt. (RMS)	V _{NOVL}	6, 7	f = 10 Hz to 1 MHz, OUT2 = 1 μF	—	—	350	μV
General purpose switches	Input/Output resistance	R _{SW1}	45, 46	SW1-INPUT = 2.8 V (Gate/Source = 2.8 V)	—	—	4.0	Ω
		R _{SW2}	51, 52	SW2-INPUT = 2.8 V (Gate/Source = 2.8 V)	—	—	7.0	Ω
		R _{SW3}	47, 48	SW3-INPUT = 2.8 V (Gate/Source = 2.8 V)	—	—	7.0	Ω

(Continued)

(Ta = +25 °C, VBAT1 to VBAT4 = VCC-VSIM = 3.6 V)

Parameter	Symbol	Pin No.	Conditions	Value			Unit	
				Min.	Typ.	Max.		
LDO3 (OUT3)	Output voltage	V _O	3, 4	-50 μA > OUT3 > -100 mA	2.700	2.800	2.900	V
	Line regulation	Line	3, 4	3.1 V < VBAT3 < 5.5 V	—	—	10	mV
	Load regulation	Load	3, 4	-50 μA > OUT3 > -100 mA	—	—	30	mV
	Ripple rejection ΔVBAT3/ΔOUT3	R.R	3, 4	f = 217 Hz	45	—	—	dB
	Dropout voltage	V _{DO}	3, 4	OUT3 = -100 mA	—	—	250	mV
	GND current at low load	I _{GND}	5	OUT3 > -1 mA	—	—	30	μA
	GND current at max. load	I _{GND}	5	OUT3 = -100 mA	—	—	2	mA
	Output noise volt. (RMS)	V _{NOVL}	3, 4	f = 10 Hz to 1 MHz, OUT3 = 1 μF	—	—	350	μV
LDO4 (OUT4)	Output voltage	V _O	40, 41	-50 μA > OUT4 > -100 mA, CONT4 = "L"	2.700	2.800	2.900	V
		V _O	40, 41	-50 μA > OUT4 > -100 mA, CONT4 = "H"	2.400	2.500	2.600	V
	Line regulation	Line	40, 41	3.1 V < VBAT4 < 5.5 V	—	—	10	mV
	Load regulation	Load	40, 41	-50 μA > OUT4 > -100 mA	—	—	30	mV
	Ripple rejection ΔVBAT4 - OUT4/ΔOUT4	R.R	40, 41	f = 217 Hz	45	—	—	dB
	Dropout voltage	V _{DO}	40, 41	OUT4 = -100 mA	—	—	250	mV
	GND current at low load	I _{GND}	39	OUT4 > -1 mA	—	—	30	μA
	GND current at max. load	I _{GND}	39	OUT4 = -100 mA	—	—	2	mA
	Output noise volt. (RMS)	V _{NOVL}	40, 41	f = 10 Hz to 1 MHz, OUT4 = 1 μF	—	—	500	μV
LDO5 (OUT5)	Output voltage	V _O	58	-50 μA > OUT5 > -50 mA	2.700	2.800	2.900	V
	Line regulation	Line	58	3.1 V < VBAT3 < 5.5 V	—	—	10	mV
	Load regulation	Load	58	-50 μA > OUT5 > -50 mA	—	—	30	mV
	Ripple rejection ΔVBAT3/ΔOUT5	R.R	58	f = 217 Hz	45	—	—	dB
	Dropout voltage	V _{DO}	58	OUT5 = -50 mA	—	—	250	mV
	GND current at low load	I _{GND}	59	OUT5 > -500 μA	—	—	20	μA
	GND current at max. load	I _{GND}	59	OUT5 = -50 mA	—	—	1	mA
	Output noise volt. (RMS)	V _{NOVL}	58	f = 10 Hz to 1 MHz, OUT5 = 1 μF	—	—	350	μV

(Continued)

(Ta = +25 °C, VBAT1 to VBAT4 = VCC-VSIM = 3.6 V)

Parameter	Symbol	Pin No.	Conditions	Value			Unit	
				Min.	Typ.	Max.		
LDO6 (V-BACKUP)	Output voltage	V _O	21	-10 μA > V-BACKUP > -250 μA	2.000	2.100	2.200	V
	Line regulation	Line	21	3.1 V < VBAT2 < 5.5 V	—	—	10	mV
	Load regulation	Load	21	-10 μA > V-BACKUP > -250 μA	—	—	30	mV
	Ripple rejection ΔVBAT2/ ΔV-BACKUP	R.R	21	f = 217 Hz	25	—	—	dB
	GND current at low load	I _{GND}	19	V-BACKUP > -10 μA	—	—	10	μA
	GND current at max. load	I _{GND}	19	V-BACKUP = -250 μA	—	—	50	μA
	Output noise volt. (RMS)	V _{NOVL}	21	f = 10 Hz to 1 MHz, V-BACKUP = 1 μF	—	—	500	μV
	Reverse current	I _{RC}	21	VBAT2 = 0 V, V-BACKUP = 3.0 V	—	—	100	nA
REF-OUT	Output voltage	V _O	24	0 μA > REF-OUT > -50 μA	1.200	1.225	1.250	V
	Line regulation	Line	24	3.1 V < VBAT2 < 5.5 V	—	—	10	mV
	Load regulation	Load	24	0 μA > REF-OUT > -50 μA	—	—	6	mV
	Ripple rejection ΔVBAT2/ ΔREF-OUT	R.R	24	f = 217 Hz	50	—	—	dB
	Output noise volt. (RMS)	V _{NOVL}	24	f = 10 Hz to 1 MHz, REF-OUT = 27 nF	—	—	250	μV
VSIMOUT chargepump	Output voltage	V _O	29	-50 μA > VSIMOUT > -10 mA, SIMPROG = "H"	4.600	5.000	5.400	V
		V _O	29	-50 μA > VSIMOUT > -10 mA, SIMPROG = "L"	2.760	3.000	3.240	V
	Line regulation	Line	29	3.1 V < VCC-VSIM < 5.5 V	—	—	50	mV
	Load regulation	Load	29	-50 μA > VSIMOUT > -10 mA	—	—	100	mV

(Continued)

(Ta = +25 °C, VBAT1 to VBAT4 = VCC-VSIM = 3.6 V)

Parameter		Symbol	Pin No.	Conditions	Value			Unit
					Min.	Typ.	Max.	
VSIMOUT chargepump	Ripple rejection $\Delta V_{CC-VSIM}/\Delta V_{SIMOUT}$	R.R	29	f = 217 Hz	30	—	—	dB
	Output current	Io	29	3.1 V < VCC-VSIM < 5.5 V, VSIMOUT = 5 V	10	—	—	mA
		Io	29	3.1 V < VCC-VSIM < 5.5 V, VSIMOUT = 3 V	6	—	—	mA
	GND current at no load	IGND	32	VSIMOUT > -50 μ A	—	—	100	μ A
	Efficiency at max. load	η	25, 29	VSIMOUT = -10 mA, VSIMOUT = 5 V	85	—	—	%
	Output ripple voltage	V _{RP}	29	f = 10 Hz to 1 MHz, VSIMOUT = 10 μ F	—	—	100	mV _{PP}
	Shutdown supply current	I _{LDO}	25	VSIM-ON = "L"	—	—	100	nA
GSM/SIM logic level translation μ p interface	Input voltage	V _{IH}	33, 34, 35	—	0.7 \times OUT1	—	OUT1	V
		V _{IL}	33, 34, 35	—	0	—	0.3 \times OUT1	V
	Output voltage	V _{OH}	35	μ P-IO (max.) = -20 μ A	0.8 \times OUT1	—	OUT1	V
		V _{OL}	35	μ P-IO (max.) = 1 mA	0	—	0.2 \times OUT1	V

(Continued)

MB3891

(Continued)

(Ta = +25 °C, VBAT1 to VBAT4 = VCC-VSIM = 3.6 V)

Parameter	Symbol	Pin No.	Conditions	Value			Unit	
				Min.	Typ.	Max.		
SIM interface 5 V (SIMPROG = H)	Output voltage	V _{OH}	36	RST (max.) = -20 µA	V _{SIMOUT} - 0.7	—	V _{SIMOUT}	V
		V _{OL}	36	RST (max.) = 200 µA	0	—	0.6	V
	Rise time	T _R	36	RESET-IN = RST = 30 pF	—	—	400	µs
	Fall time	T _F	36	RESET-IN = RST = 30 pF	—	—	400	µs
	Output voltage	V _{OH}	37	CLK (max.) = -20 µA	0.7 × V _{SIMOUT}	—	V _{SIMOUT}	V
		V _{OL}	37	CLK (max.) = 200 µA	0	—	0.5	V
	Rise time	T _R	37	CLK-IN = CLK = 30 pF	—	—	27	ns
	Fall time	T _F	37	CLK-IN = CLK = 30 pF	—	—	27	ns
	Output voltage	V _{OH}	38	SIM-IO (max.) = -20 µA	3.8	—	V _{SIMOUT}	V
		V _{OL}	38	SIM-IO (max.) = 1 mA	0	—	0.4	V
	Input voltage	V _{IH}	38	—	0.7 × V _{SIMOUT}	—	V _{SIMOUT}	V
		V _{IL}	38	—	0	—	0.8	V
	Rise time	T _R	38	SIM-IO = 30 pF	—	—	1	µs
	Fall time	T _F	38	SIM-IO = 30 pF	—	—	1	µs
SIM interface 3 V (SIMPROG = L)	Output voltage	V _{OH}	36	RST (max.) = -20 µA	0.8 × V _{SIMOUT}	—	V _{SIMOUT}	V
		V _{OL}	36	RST (max.) = 200 µA	0	—	0.2 × V _{SIMOUT}	V
	Rise time	T _R	36	RESET-IN = RST = 30 pF	—	—	400	µs
	Fall time	T _F	36	RESET-IN = RST = 30 pF	—	—	400	µs
	Output voltage	V _{OH}	37	CLK (max.) = -20 µA	0.7 × V _{SIMOUT}	—	V _{SIMOUT}	V
		V _{OL}	37	CLK (max.) = 200 µA	0	—	0.2 × V _{SIMOUT}	V
	Rise time	T _R	37	CLK-IN = CLK = 30 pF	—	—	50	ns
	Fall time	T _F	37	CLK-IN = CLK = 30 pF	—	—	50	ns
	Output voltage	V _{OH}	38	SIM-IO (max.) = -20 µA	0.7 × V _{SIMOUT}	—	V _{SIMOUT}	V
		V _{OL}	38	SIM-IO (max.) = 1 mA	0	—	0.4	V
	Input voltage	V _{IH}	38	—	0.7 × V _{SIMOUT}	—	V _{SIMOUT}	V
		V _{IL}	38	—	0	—	0.2 × V _{SIMOUT}	V
	Rise time	T _R	38	SIM-IO = 30 pF	—	—	1	µs
	Fall time	T _F	38	SIM-IO = 30 pF	—	—	1	µs

TYPICAL CHARACTERISTICS

Power supply current vs. power supply voltage

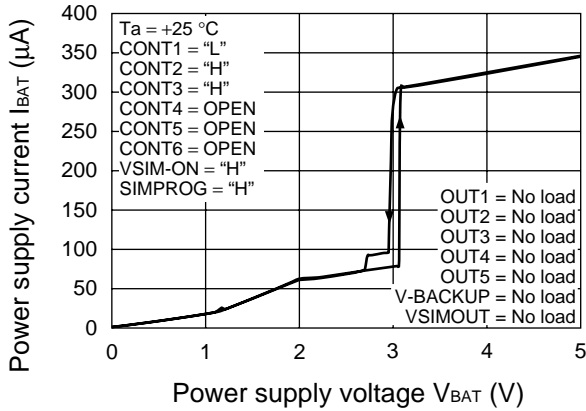

Power supply current vs. power supply voltage

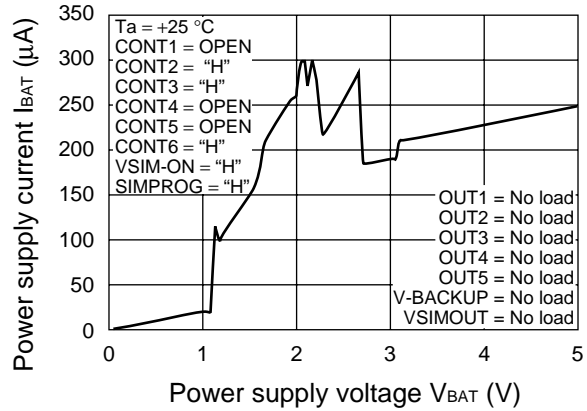

Power supply current, GND current vs. power supply voltage

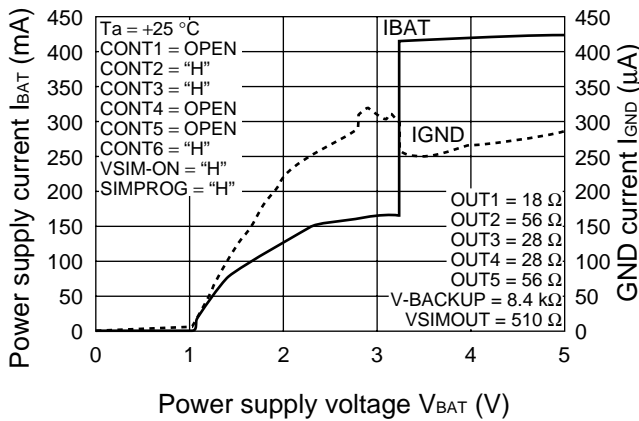

Output voltage vs. power supply voltage (LDO1)

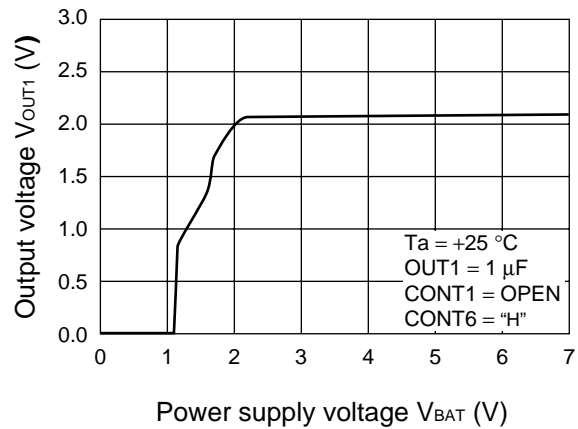

Output voltage vs. power supply voltage (LDO1)

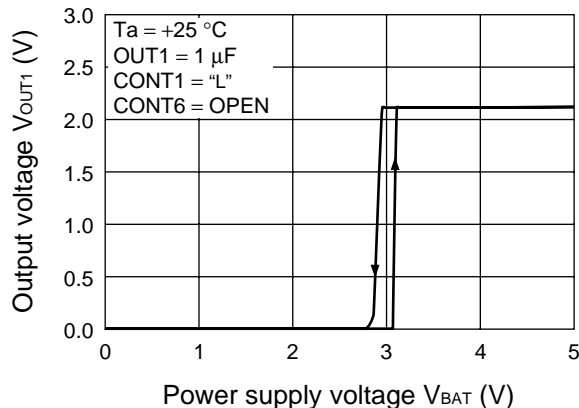

Output voltage vs. load current (LDO1)

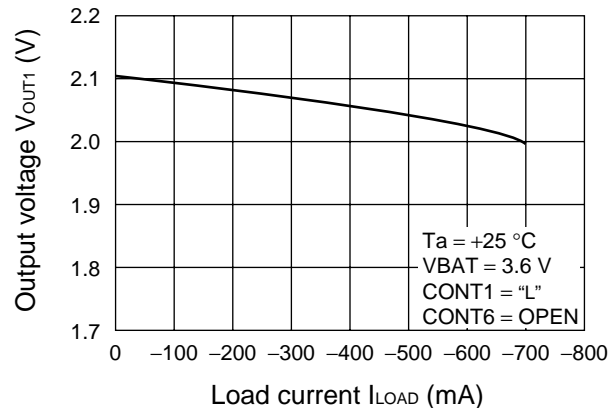

(Continued)

Ripple rejection vs. frequency (LDO1)

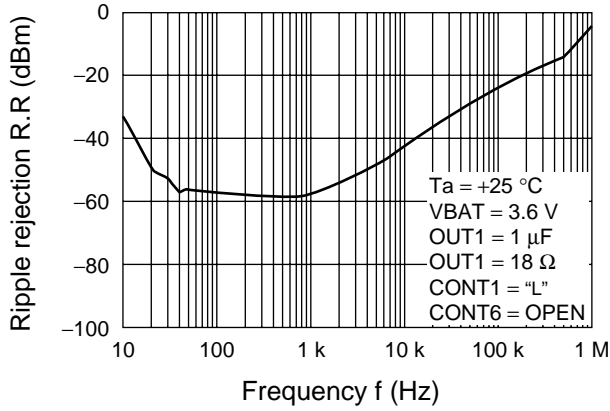

Ripple rejection vs. frequency (LDO1)

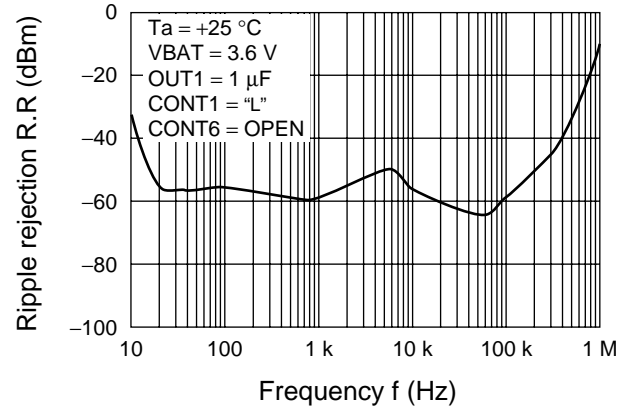

Dropout voltage vs. load current (LDO1)

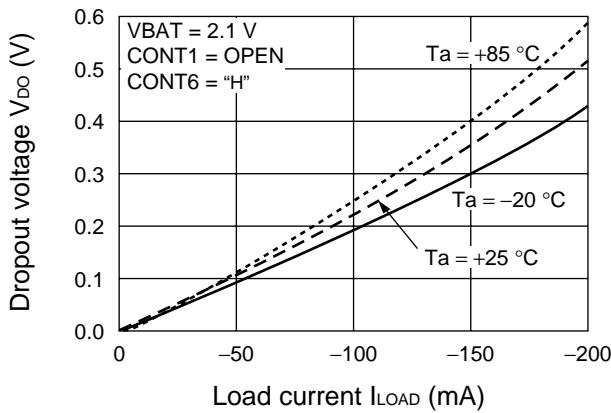

Output voltage vs. ambient temperature (LDO1)

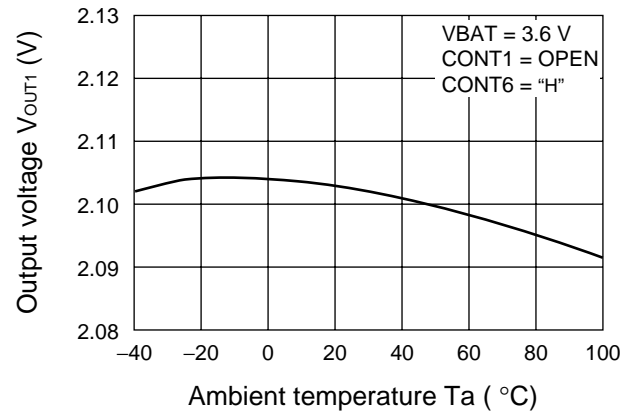

Output voltage rising waveforms (LDO1)

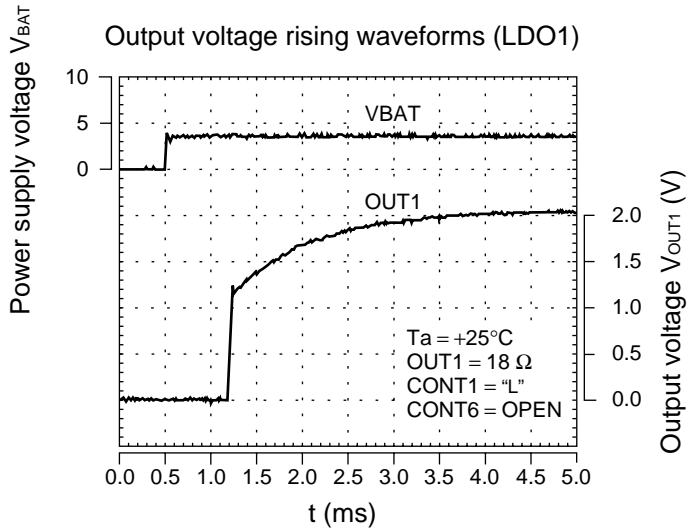

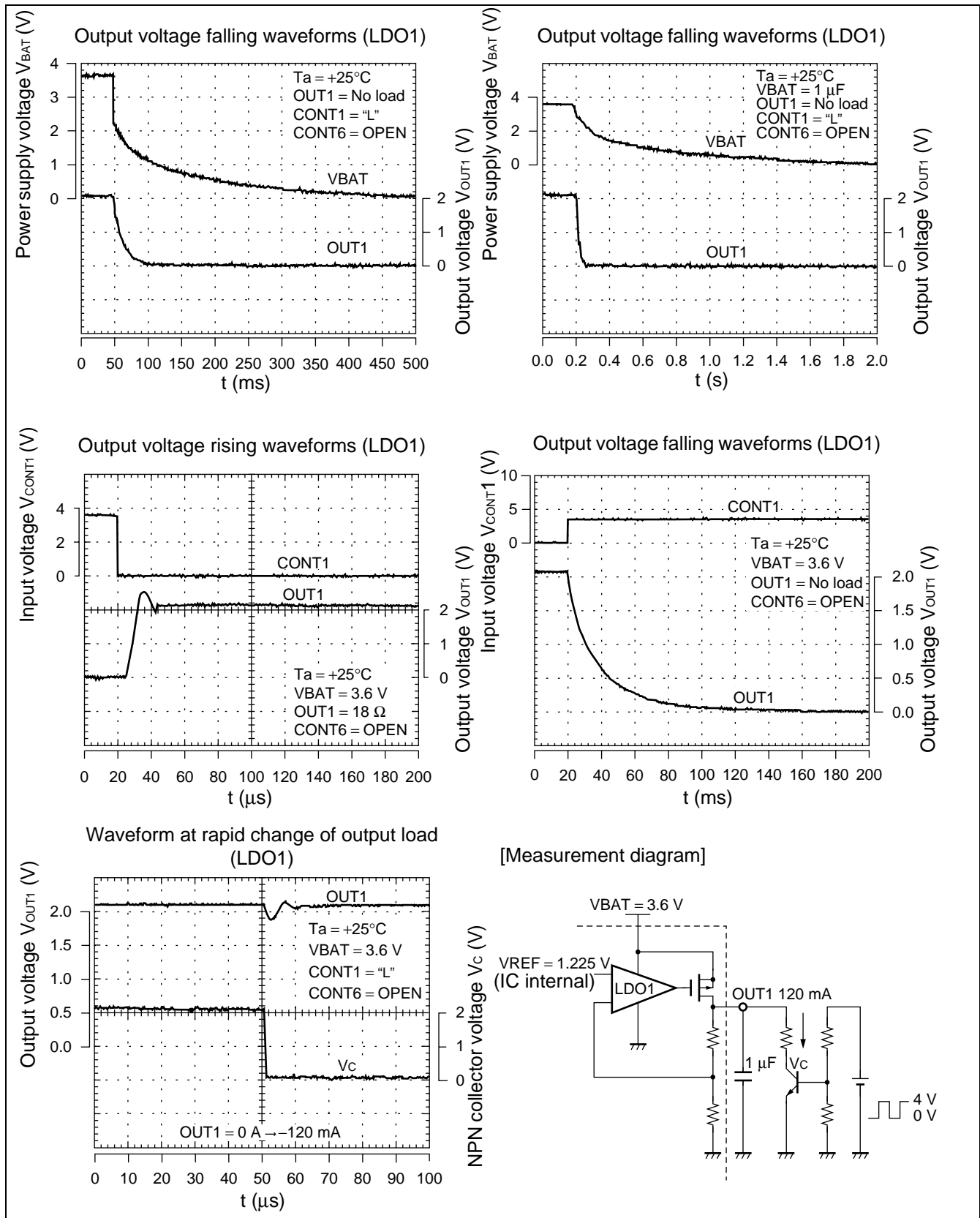

(Continued)

Waveform at rapid change of output load (LDO1)

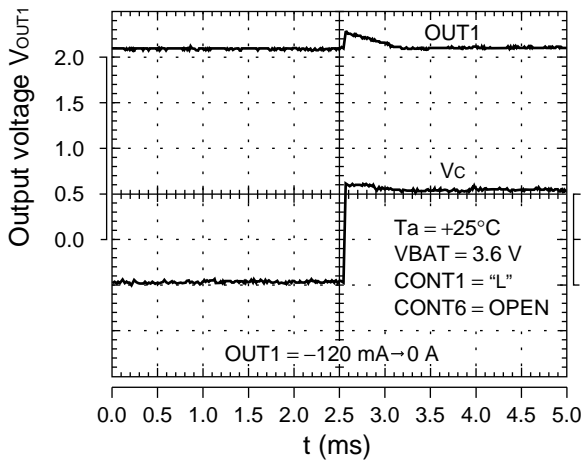

[Measurement diagram]

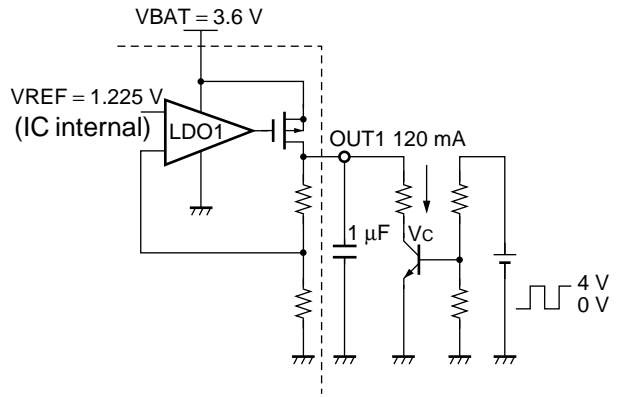

Waveform at rapid change of output load (LDO2)

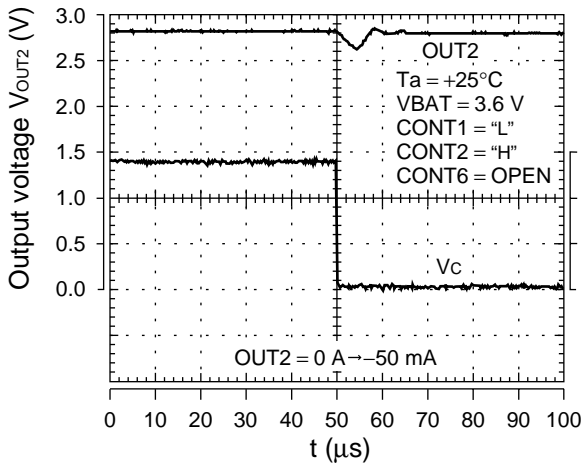

[Measurement diagram]

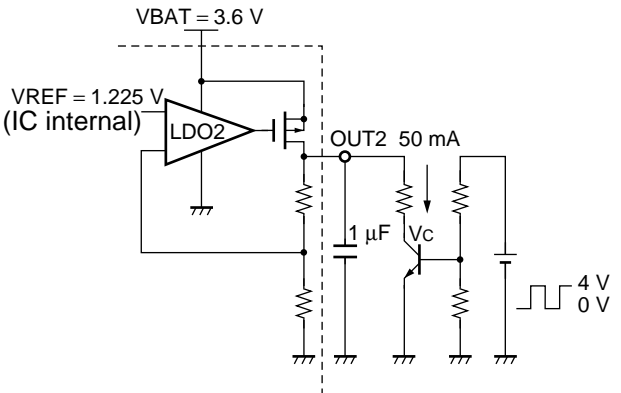

Waveform at rapid change of output load (LDO2)

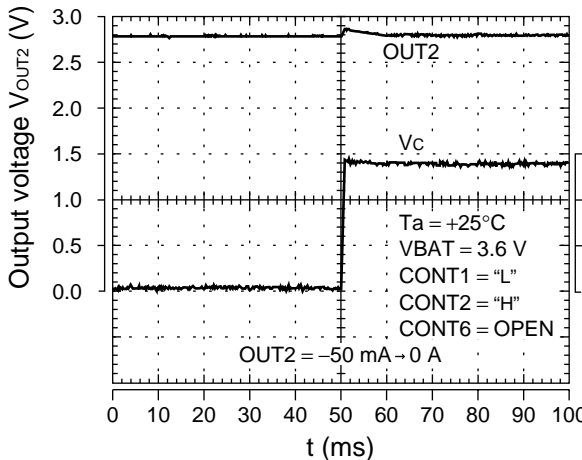

[Measurement diagram]

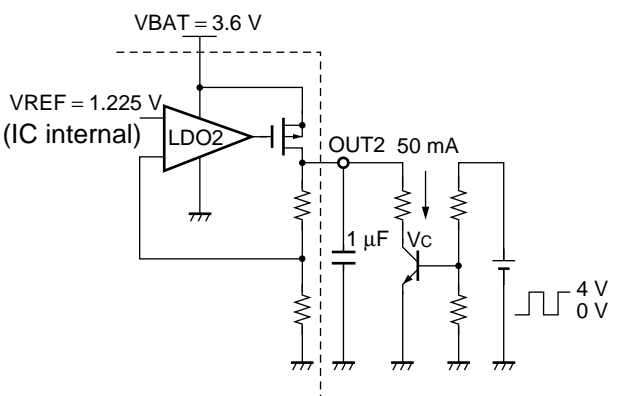

(Continued)

Reference voltage vs. power supply voltage

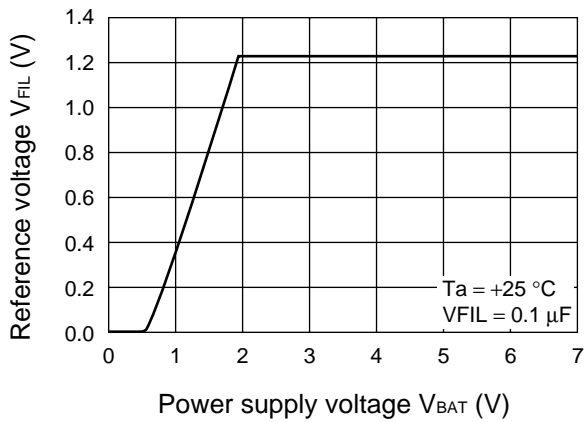

Reference voltage vs. ambient temperature

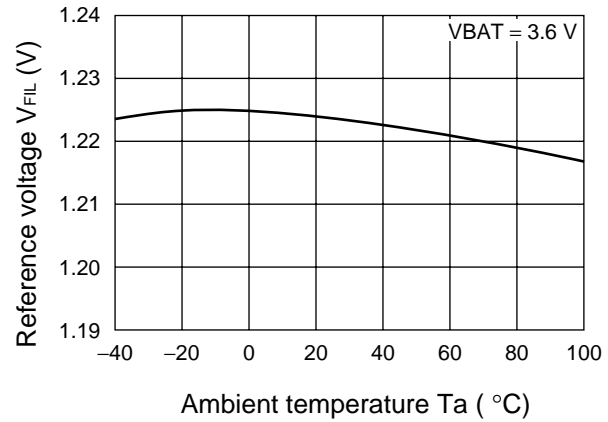

Power supply current vs. power supply voltage (VSIMOUT Chargepump)

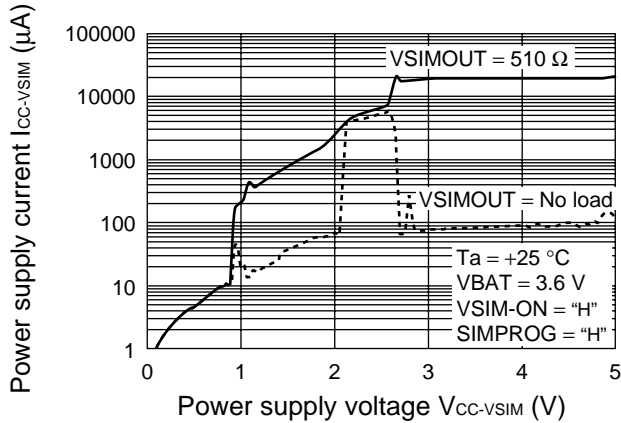

Power supply current vs. power supply voltage (VSIMOUT Chargepump)

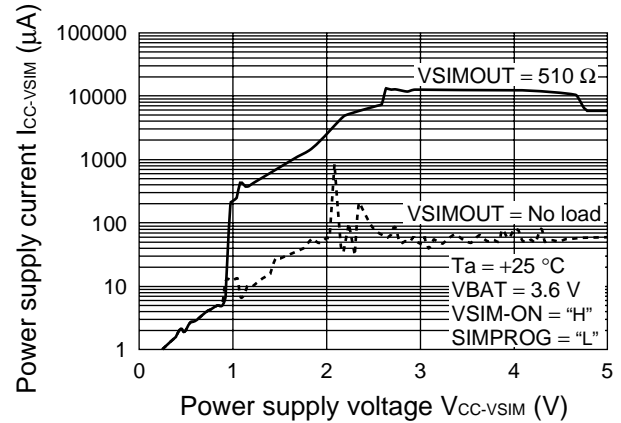

Output voltage vs. power supply voltage (VSIMOUT Chargepump)

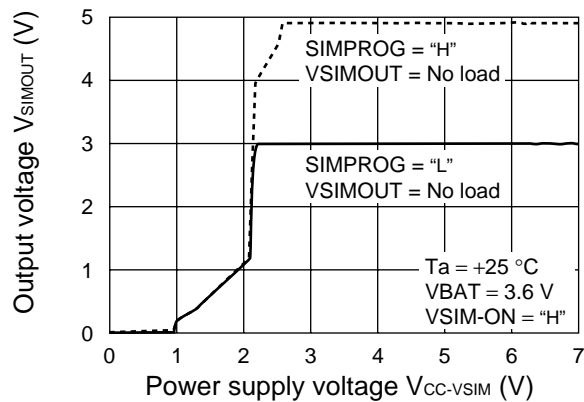

(Continued)

Output voltage vs. load current
(VSIMOUT Chargepump)

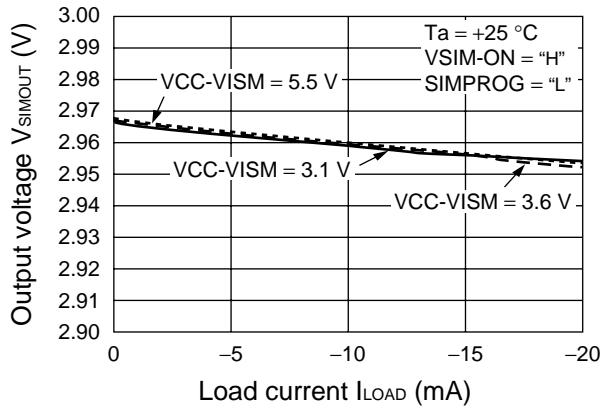

Output voltage vs. load current
(VSIMOUT Chargepump)

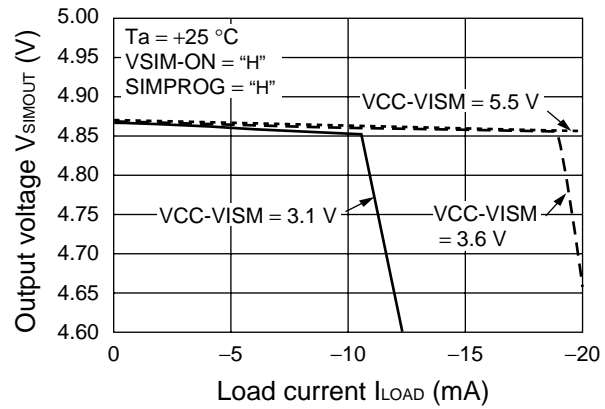

Ripple rejection vs. frequency
(VSIMOUT Chargepump)

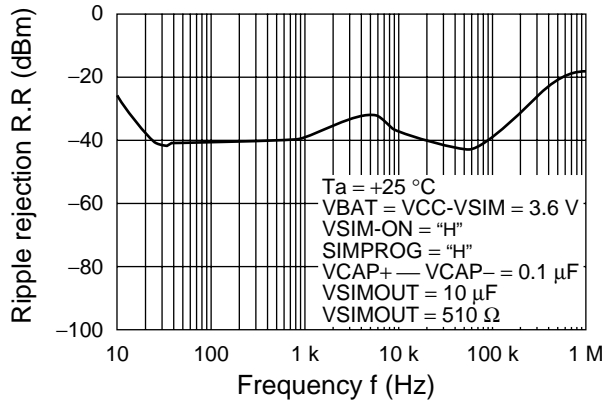

Ripple rejection vs. frequency
(VSIMOUT Chargepump)

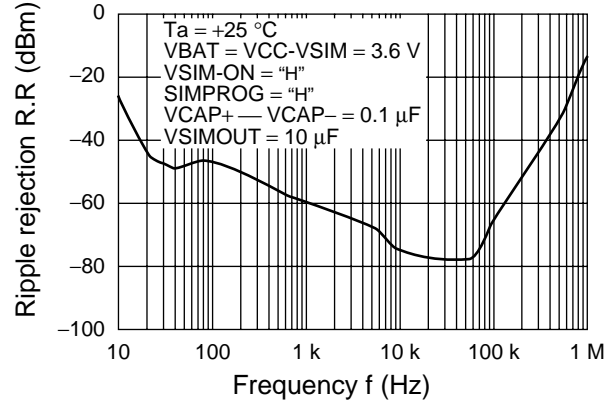

Ripple rejection vs. frequency
(VSIMOUT Chargepump)

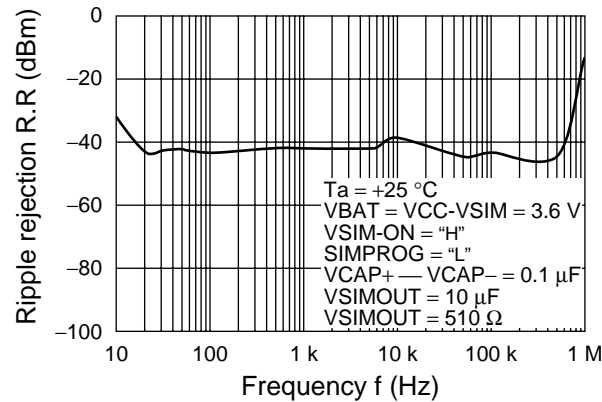

Ripple rejection vs. frequency
(VSIMOUT Chargepump)

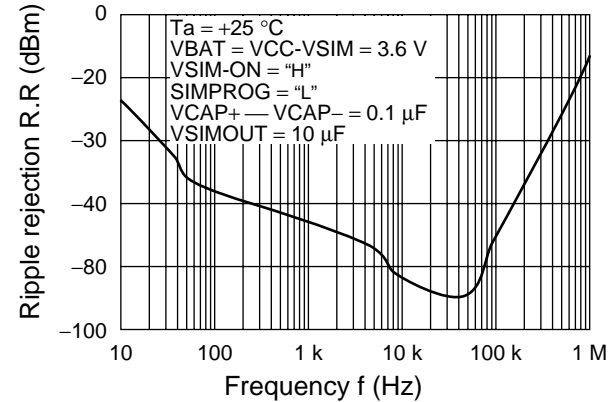

(Continued)

Efficiency vs. power supply voltage
(VSIMOUT Chargepump)

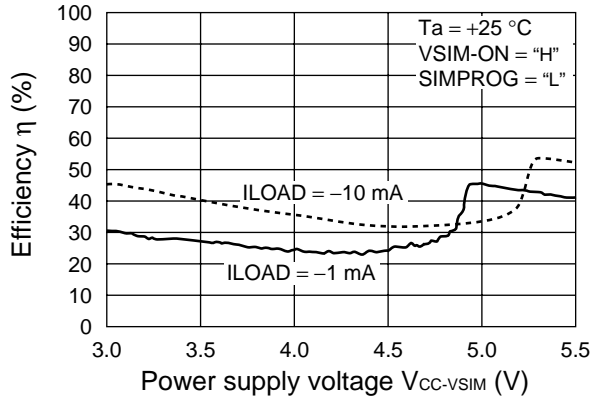

Efficiency vs. power supply voltage
(VSIMOUT Chargepump)

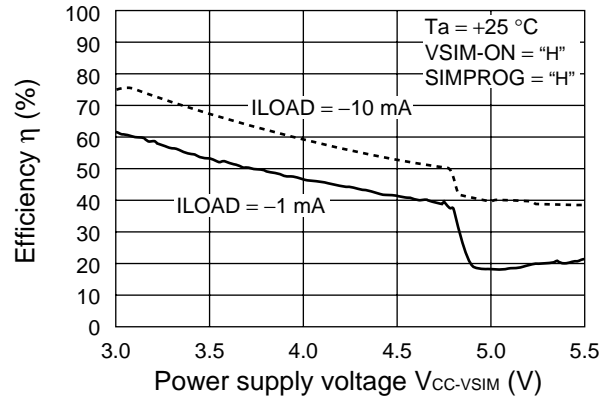

Efficiency vs. load current
(VSIMOUT Chargepump)

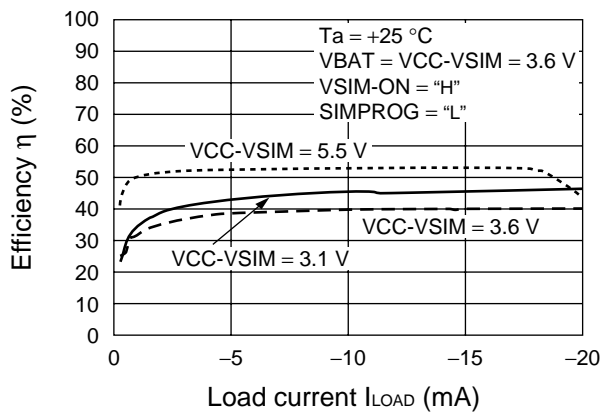

Efficiency vs. load current
(VSIMOUT Chargepump)

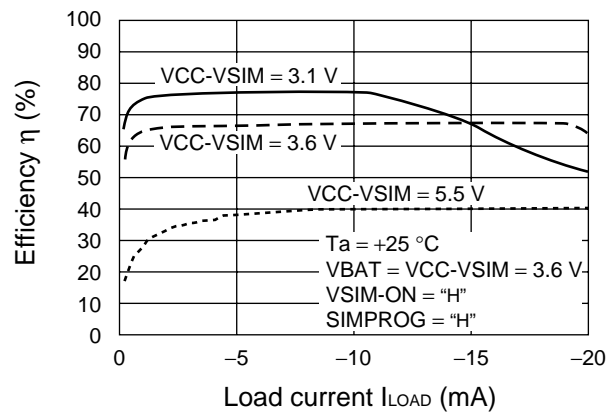

Output voltage rising waveforms
(VSIMOUT Chargepump)

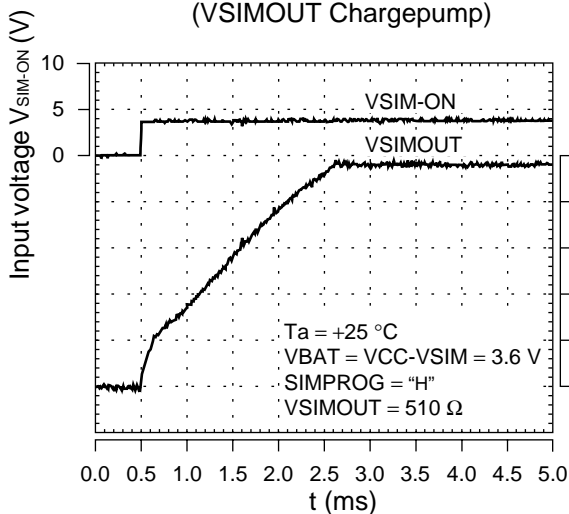

Output voltage rising waveforms
(VSIMOUT Chargepump)

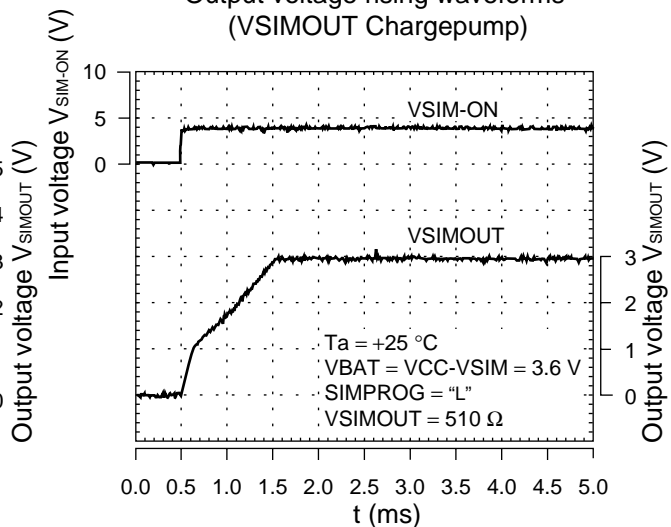

(Continued)

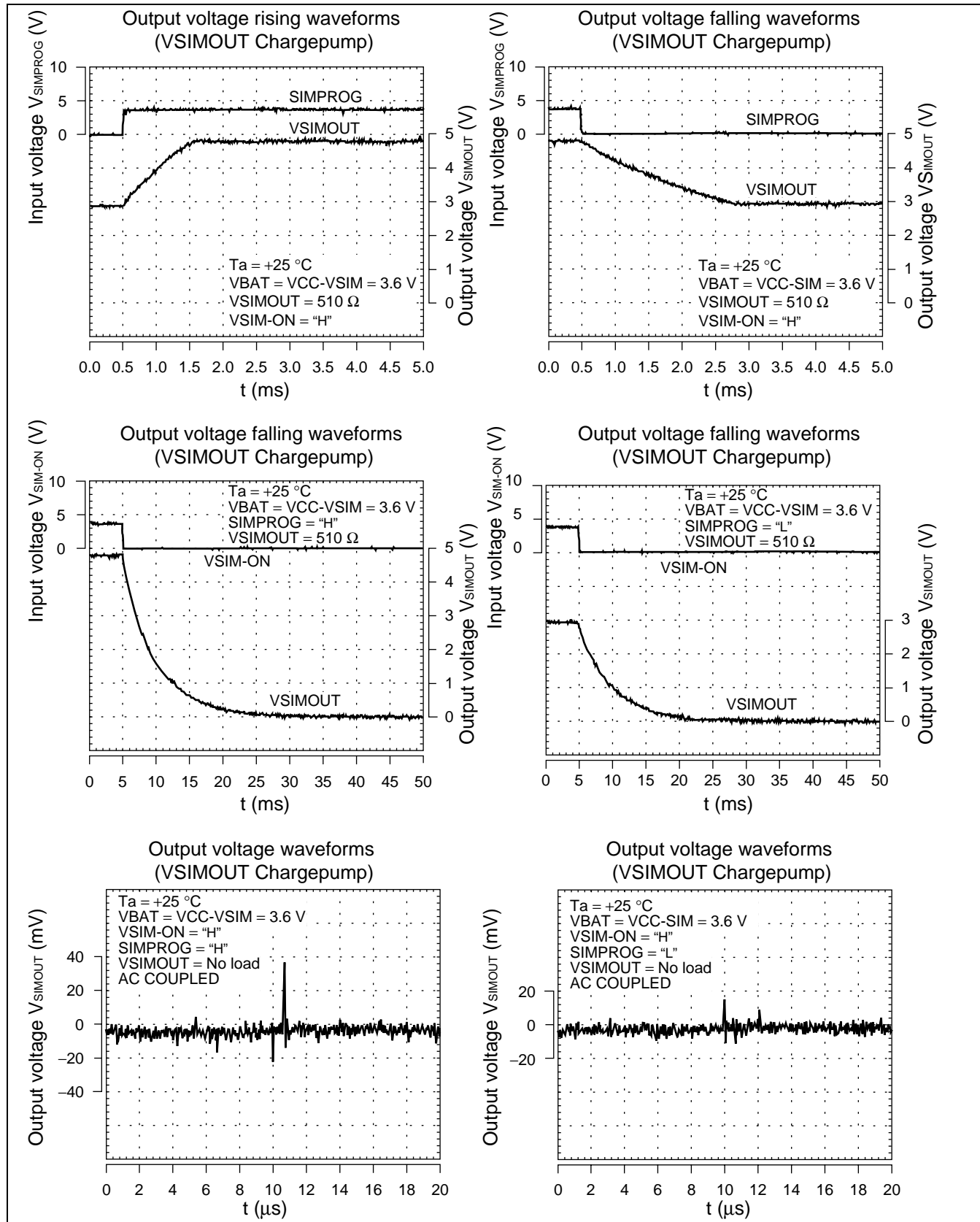

(Continued)

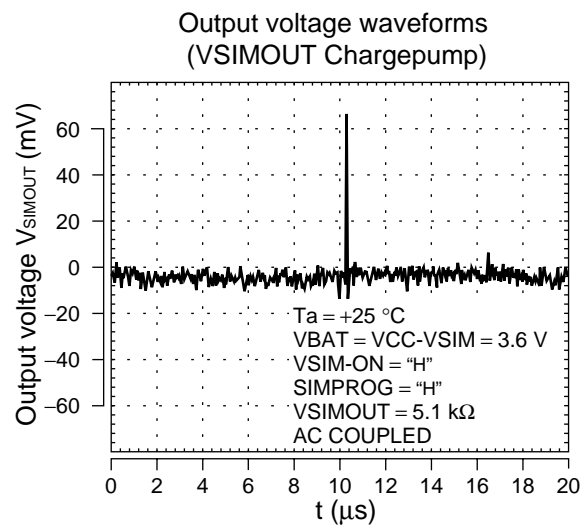
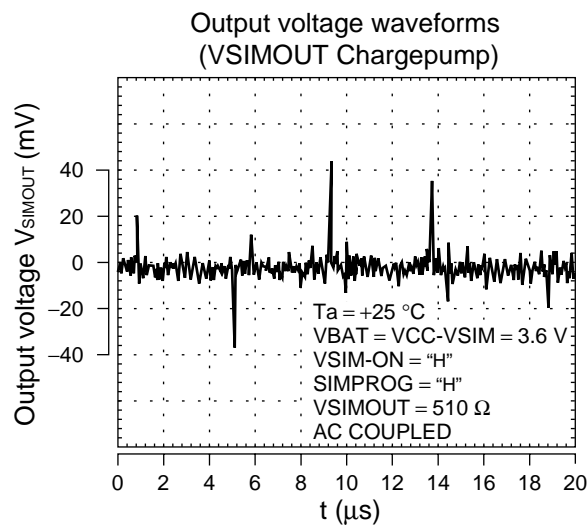
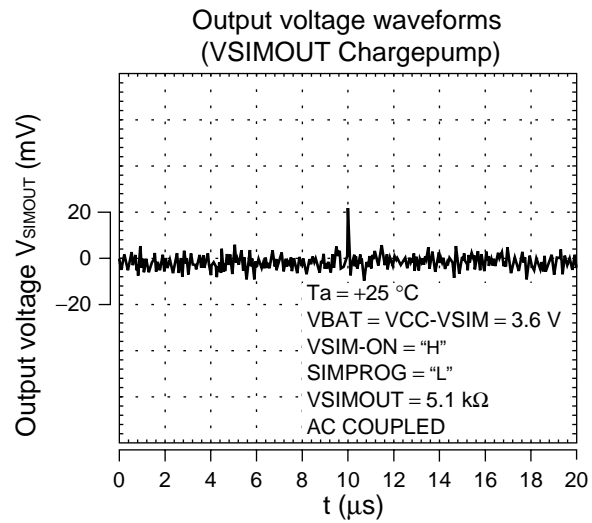
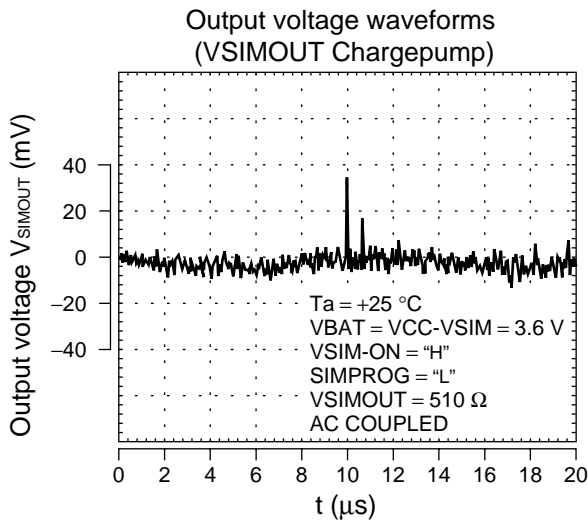

Output voltage vs. input voltage (SIM Inter-

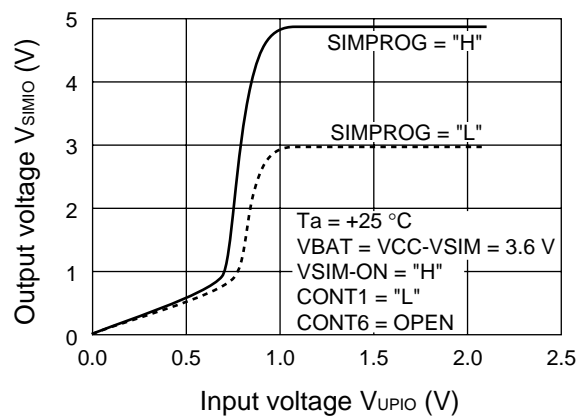

Output voltage vs. input voltage (SIM Interface)

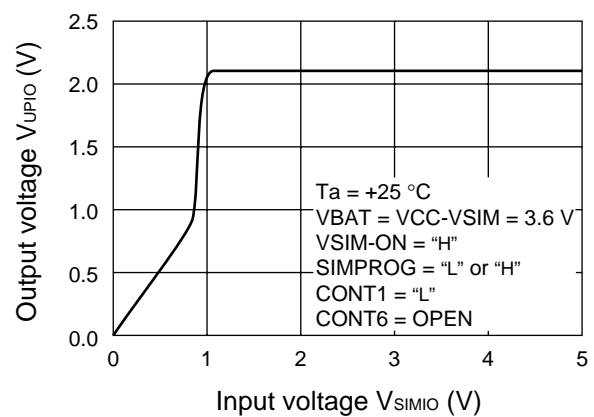

(Continued)

(Continued)

Output voltage vs. ambient temperature
(SIM Interface)

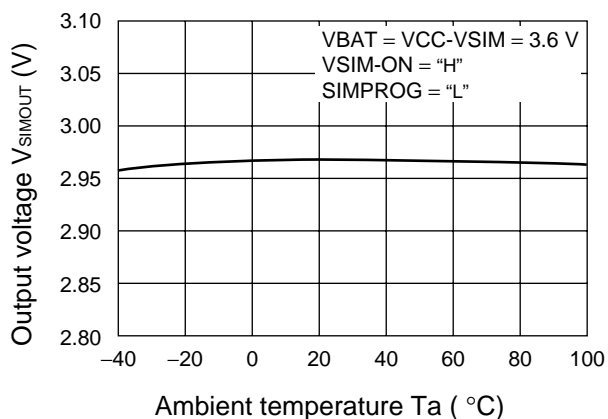

Output voltage vs. ambient temperature
(SIM Interface)

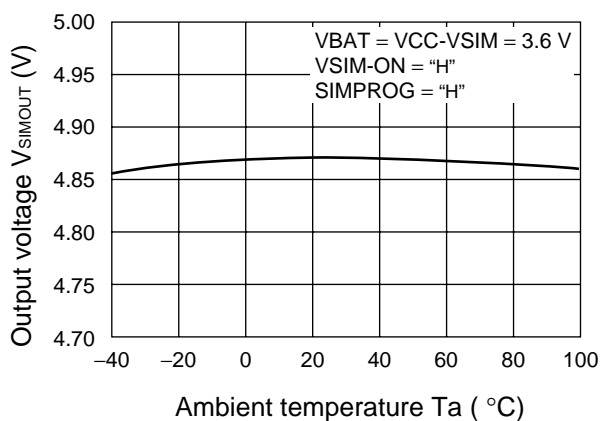

Power dissipation vs. ambient temperature

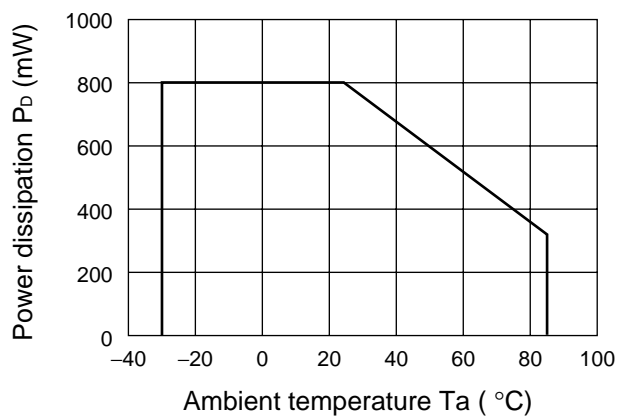

■ FUNCTIONAL DESCRIPTION

(1) MAIN UVLO/BACKUP UVLO

Transient power-on surge states or sudden drops in supply voltage (VBAT2) can cause an IC to operate abnormally, leading to destruction or damage to system elements. To prevent this type of fault, the undervoltage lockout circuits (UVLO/ Backup UVLO) will shut off the output from OUT1 to V-BACKUP if the supply voltage falls below the UVLO circuit threshold voltage (3.0 V/2.8 V typ.). System operation is restored as soon as the supply voltage rises above the UVLO circuits threshold voltage (3.2 V typ.).

(2) LDO1

The LDO1 circuits uses the reference voltage supply and generates an output voltage (2.1 V typ.) at the OUT1 terminal (pin 12,13). Power can be drawn from the OUT1 terminal for external use, up to a maximum load current of 120 mA.

(3) XPOWERGOOD (RESET)

When the OUT1 terminal (pin 12,13) voltage exceeds 2.0 V (typ.), after a delay interval set by a capacitor (C_{DELAYCAP}) connected to the DELAYCAP terminal (pin 18), the XPOWERGOOD terminal (pin 17) goes to "H" level and resets the microcomputer. At the same time, the LDO2, LDO3, and LDO4 output is controlled ON/OFF.

(4) LDO2

The LDO2 circuit uses the reference voltage supply and generates an output voltage (2.8 V typ.) at the OUT2 terminal (pin 6,7) when the XPOWERGOOD terminal (pin 17) voltage is at "H" level and an "H" level signal is input at the CONT2 terminal (pin 16). Power can be drawn from the OUT2 terminal for external use, up to a maximum load current of 50 mA.

(5) General Purpose switches

Any of the OUT terminals can be connected to any SW-INPUT terminal so that when the corresponding SW-ON terminal is at "H" level, the OUT terminal voltage can be drawn from the associated SW-OUTPUT terminal.

(6) LDO3

The LDO3 circuits uses the reference voltage supply and generates an output voltage (2.8 V typ.) at the OUT3 terminal (pin 3,4) when the XPOWERGOOD terminal (pin 17) voltage is at "H" level and an "H" level signal is input at the CONT3 terminal (pin 56). Power can be drawn from the OUT3 terminal for external use, up to a maximum load current of 100 mA.

(7) LDO4

The LDO4 circuits uses the reference voltage supply and generates an output voltage (2.8 V typ.) at the OUT4 terminal (pin 40,41) when the XPOWERGOOD terminal (pin 17) voltage is at "H" level and an "H" level signal is input at the CONT3 terminal (pin 56) , and an "L" level signal is input at the CONT4 terminal (pin 44). When an "H" level signal is input at the CONT4 terminal, the output voltage at the OUT4 terminal is 2.5 V (typ.). Power can be drawn from the OUT4 terminal for external use, up to a maximum load current of 100 mA.

(8) LDO5

The LDO5 circuit uses the reference voltage supply and generates an output voltage (2.8 V typ.) at the OUT5 terminal (pin 57) when the OUT1 terminal (pin 12,13) is in output state and an "H" level signal is input at the CONT5 terminal (pin 57). Power can be drawn from the OUT5 terminal for external use, up to a maximum load current of 50 mA.

(9) LDO6

The LDO6 circuit uses the reference voltage supply and generates an output voltage (2.1 V typ.) at the V-BACKUP terminal (pin 21). Power can be drawn for external use, from the V-BACKUP terminal, up to a maximum load current of 250 μ A.

(10) REF-OUT

This circuit uses the reference voltage generated by the reference voltage block (1.225 V typ.) to produce a temperature compensated reference voltage (1.225 V typ.) at the REF-OUT terminal (pin 24) by means of a voltage follower. The reference voltage can also be drawn from the REF-OUT terminal for external use, up to a load current of 50 μ A.

(11) VSIMOUT Chargepump

The VSIMOUT charge pump uses the voltage from the battery and generates 5.0 V (typ.) voltage at the VSIMOUT terminal (pin 29) when an "H" level signal is input at the SIMPROG terminal (pin 27), or 3.0 V (typ.) voltage when an "L" level signal is input at the SIMPROG terminal. This voltage can also be drawn from the VSIMOUT terminal for external use, up to a load current of 10 mA.

(12) GSM/SIM Logic Translation μ P Interface

When a signal is input from the microprocessor to the RESET-IN terminal (pin 33) and CLK-IN terminal (pin 34), a level-shifted voltage is output from the RST terminal (pin 36) and CLK terminal (pin 37) to the SIM card. The μ P-IO terminal (pin 35) and SIM-IO terminal (pin 38) are input/output pins and carry signals between the microprocessor and SIM card.

(13) SIM Interface 5 V (SIMPROG = "H")

When an "H" level signal is input to the SIMPROG terminal (pin 27), 5.0 V (typ.) voltage is generated from the VSIMOUT terminal (pin 29) as a power supply for the SIM card.

(14) SIM Interface 3 V (SIMPROG = "L")

When an "L" level signal is input to the SIMPROG terminal (pin 27), 3.0 V (typ.) voltage is generated from the VSIMOUT terminal (pin 29) as a power supply for the SIM card.

■ SETTING THE XPOWERGOOD TIME

When the OUT1 terminal (pin 12,13) voltage exceeds 2.0 V (typ.), the capacitor (C_{DELAYCAP}) connected to the DELAYCAP terminal (pin 18) starts charging, the XPOWERGOOD terminal (pin 17) voltage rises. The XPOWERGOOD terminal voltage rising time (XPOWERGOOD time) can be set by a capacitor connected to the DELAYCAP terminal.

$$\text{XPOWERGOOD time} : T_{\text{XPG}} (\text{s}) \cong 0.8 \times C_{\text{DELAYCAP}} (\mu\text{F})$$

OPERATION TIMING CHART

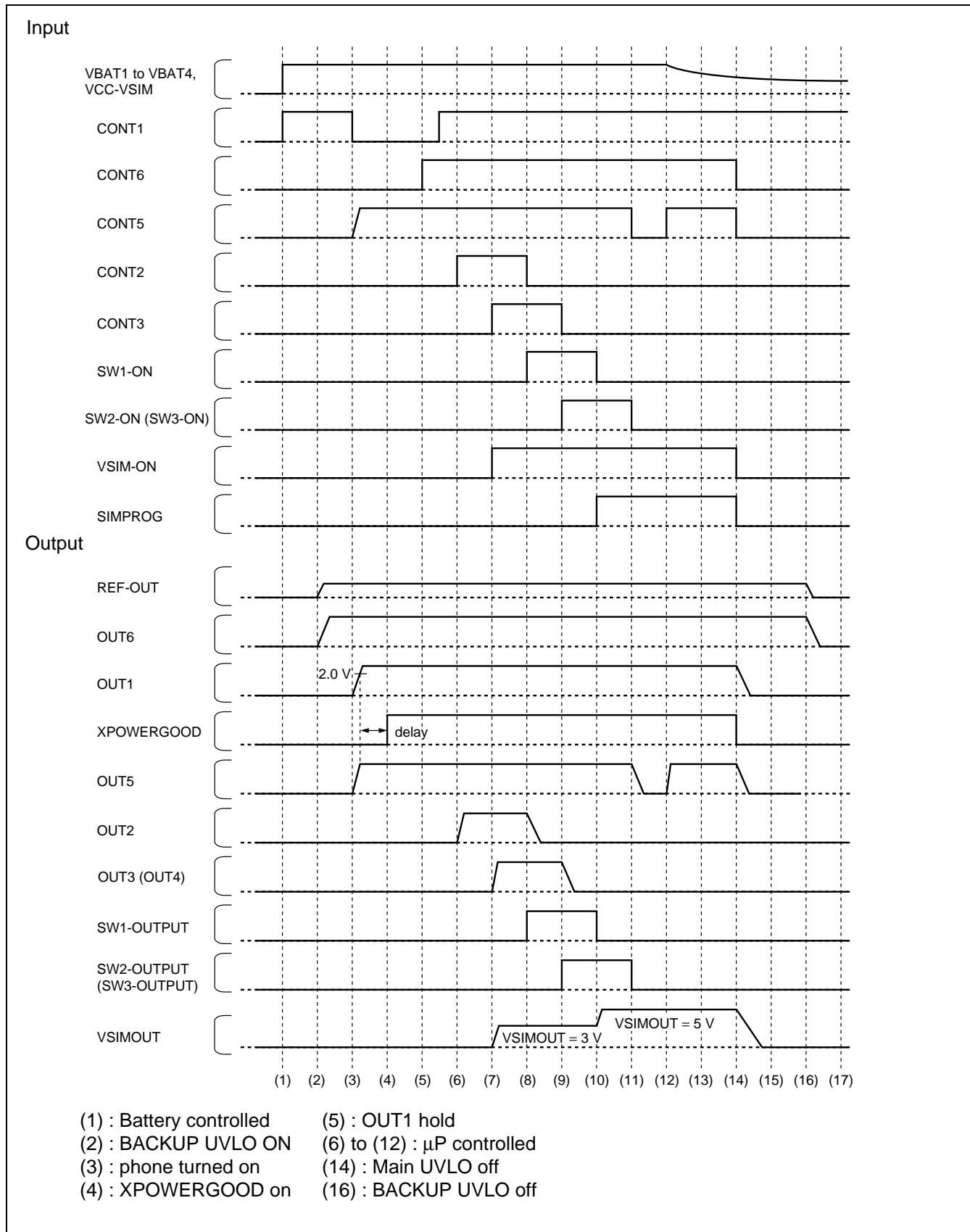

APPLICATION EXAMPLE

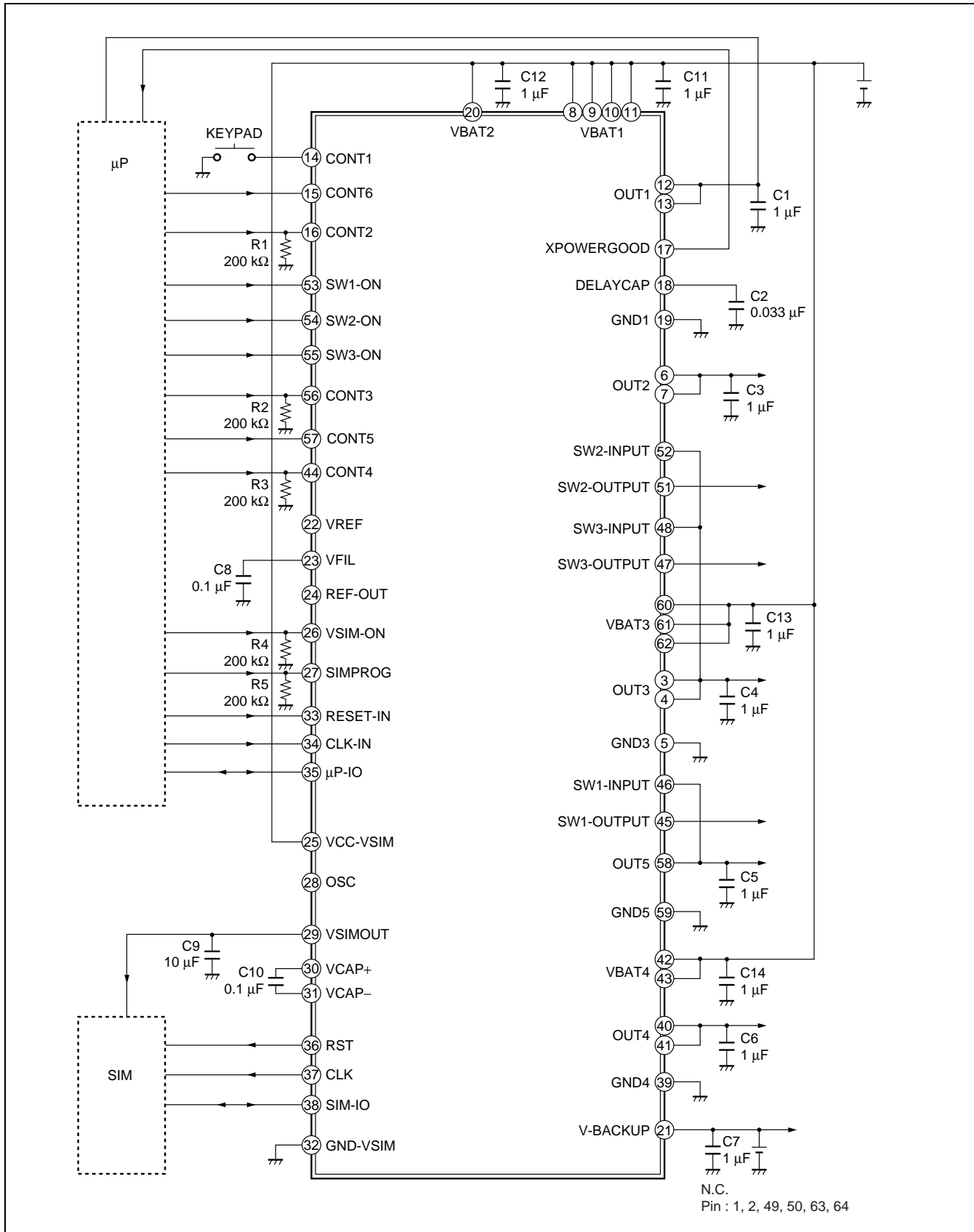

■ USAGE PRECAUTIONS

- Printed circuit board ground lines should be set up with consideration for common impedance.
- Take appropriate static electricity measures.
 - Containers for semiconductor materials should have anti-static protection or be made of conductive material.
 - After mounting, printed circuit boards should be stored and shipped in conductive bags or Containers.
 - Work platforms, tools, and instruments should be properly grounded.
 - Working personal should be grounded with resistance of 250 k Ω to 1 M Ω between body and ground.
- Do not apply negative voltages

The use of negative voltages below -0.3V may create parasitic transistors on LSI lines, Which can cause abnormal operation.

■ ORDERING INFORMATION

Part number	Package	Remarks
MB3891PFV	64-pin Plastic LQFP (FPT-64P-M03)	

MB3891

PACKAGE DIMENSION

64-pin plastic LQFP
(FPT-64P-M03)

Note : Pins width and pins thickness include plating thickness.

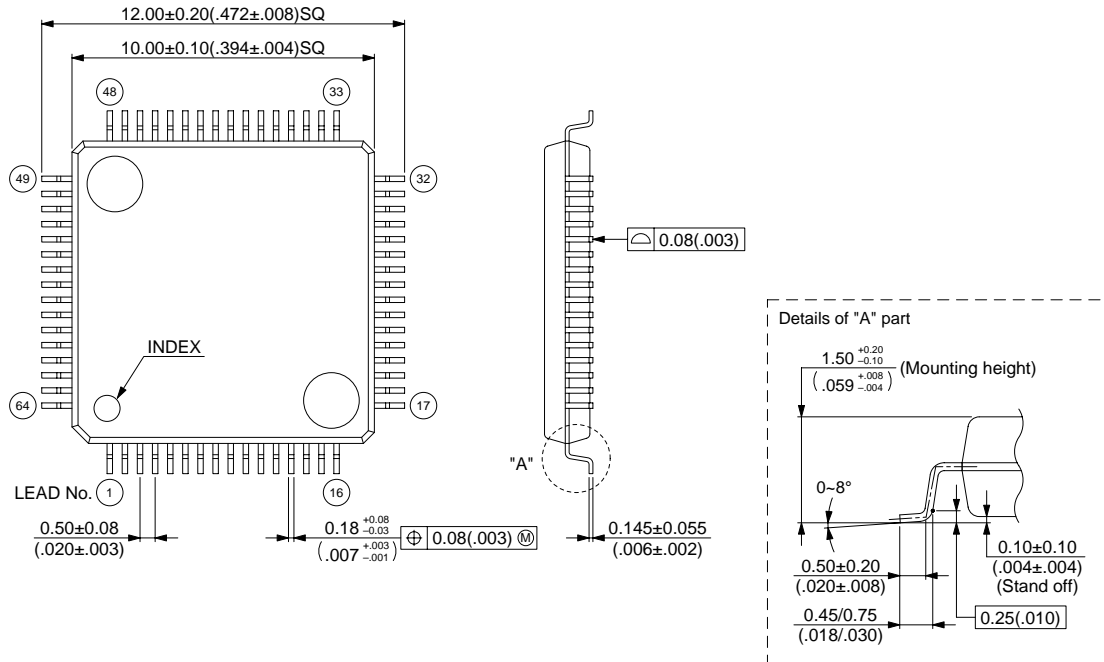

© 1998 FUJITSU LIMITED F64009S-3C-6

Dimensions in mm (inches) .

FUJITSU LIMITED

All Rights Reserved.

The contents of this document are subject to change without notice. Customers are advised to consult with FUJITSU sales representatives before ordering.

The information and circuit diagrams in this document are presented as examples of semiconductor device applications, and are not intended to be incorporated in devices for actual use. Also, FUJITSU is unable to assume responsibility for infringement of any patent rights or other rights of third parties arising from the use of this information or circuit diagrams.

The products described in this document are designed, developed and manufactured as contemplated for general use, including without limitation, ordinary industrial use, general office use, personal use, and household use, but are not designed, developed and manufactured as contemplated (1) for use accompanying fatal risks or dangers that, unless extremely high safety is secured, could have a serious effect to the public, and could lead directly to death, personal injury, severe physical damage or other loss (i.e., nuclear reaction control in nuclear facility, aircraft flight control, air traffic control, mass transport control, medical life support system, missile launch control in weapon system), or (2) for use requiring extremely high reliability (i.e., submersible repeater and artificial satellite).

Please note that Fujitsu will not be liable against you and/or any third party for any claims or damages arising in connection with above-mentioned uses of the products.

Any semiconductor devices have an inherent chance of failure. You must protect against injury, damage or loss from such failures by incorporating safety design measures into your facility and equipment such as redundancy, fire protection, and prevention of over-current levels and other abnormal operating conditions.

If any products described in this document represent goods or technologies subject to certain restrictions on export under the Foreign Exchange and Foreign Trade Law of Japan, the prior authorization by Japanese government will be required for export of those products from Japan.

F0007

© FUJITSU LIMITED Printed in Japan