

TENTATIVE

TOSHIBA PHOTOCOUPLER GaAs IRED + PHOTO-TRIAC

TLP762J

OFFICE MACHINE
HOUSEHOLD USE EQUIPMENT
TRIAC DRIVER
SOLID STATE RELAY

The TOSHIBA TLP762J consists of a GaAs infrared LED optically coupled to a photo-triac in a 6 lead plastic DIP.

- Peak Off-State Voltage : 600V (MIN.)
- Trigger LED Current : 10mA (MAX.)
- On-State Current : 100mA (MAX.)
- Isolation Voltage : 4000Vrms (MIN.)
- UL Recognized : UL1577, File No. E67349
- BSI Approved : BS EN60065 : 1994, Certificate No. 7831
BS EN60950 : 1992, Certificate No. 7832
- SEMKO Approved : SS EN60065 (EN60065, 1993)
SS EN60950 (EN60950, 1992)
SS EN60335 (EN60335, 1988)
Certificate No. 9522145
- Option (D4) type VDE Approved : DIN VDE0884 / 06.92
Certificate No. 91803
Maximum Operating Insulation Voltage : 890V_{PK}
Highest Permissible Over Voltage : 6000V_{PK}

(Note) When a VDE0884 approved type is needed, please designate the "Option (D4)"

| | 7.62mm pich TLP762J type | 10.16mm pich TLP762JF type |
|------------------------|-----------------------------|-------------------------------|
| ● Creepage Distance | : 7.0mm (Min.) | 8.0mm (Min.) |
| Clearance | : 7.0mm (Min.) | 8.0mm (Min.) |
| Internal Creepage Path | : 4.0mm (Min.) | 4.0mm (Min.) |
| Insulation Thickness | : 0.5mm (Min.) | 0.5mm (Min.) |

Unit in mm

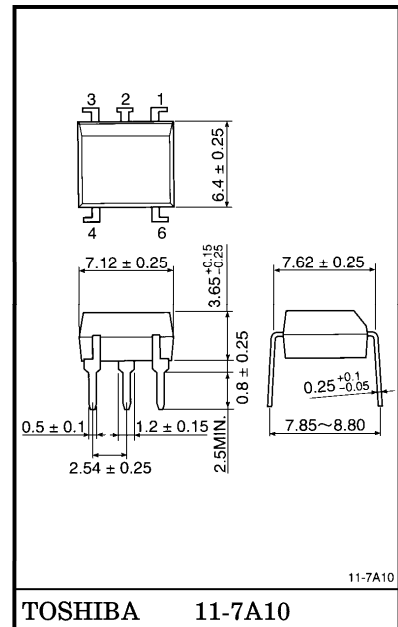

TOSHIBA 11-7A10

Weight : 0.42g

PIN CONFIGURATION (TOP VIEW)

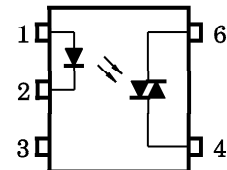

- 1 : ANODE
- 2 : CATHODE
- 3 : N.C.
- 4 : TRIAC 1
- 6 : TRIAC 2

MAXIMUM RATINGS (Ta = 25°C)

| CHARACTERISTIC | | SYMBOL | RATING | UNIT |
|--|--|---------------------|------------------|-------|
| LED | Forward Current | I _F | 50 | mA |
| | Forward Current Derating (Ta ≥ 53°C) | ΔI _F /°C | -0.7 | mA/°C |
| | Peak Forward Current (100μs pulse, 100pps) | I _{FP} | 1 | A |
| | Reverse Voltage | V _R | 5 | V |
| | Junction Temperature | T _j | 125 | °C |
| DETECTOR | Off-State Output Terminal Voltage | V _{DRM} | 600 | V |
| | On-State RMS Current | Ta = 25°C | 100 | mA |
| | | Ta = 70°C | 50 | |
| | On-State Current Derating (Ta = ≥ 25°C) | ΔI _T /°C | -1.1 | mA/°C |
| | Peak On-State Current (100μs pulse, 120pps) | I _{TP} | 2 | A |
| | Peak Nonrepetitive Surge Current (PW = 10ms, DC = 10%) | I _{TSM} | 1.2 | A |
| | Junction Temperature | T _j | 115 | °C |
| Storage Temperature Range | T _{stg} | -55~125 | °C | |
| Operating Temperature Range | T _{opr} | -40~100 | °C | |
| Lead Soldering Temperature (10s) | T _{sol} | 260 | °C | |
| Isolation Voltage (AC, 1 min., R.H. ≤ 60%) | BV _S | 4000 | V _{rms} | |

RECOMMENDED OPERATING CONDITIONS

| CHARACTERISTIC | SYMBOL | MIN. | TYP. | MAX. | UNIT |
|-----------------------|------------------|------|------|------|-----------------|
| Supply Voltage | V _{AC} | — | — | 240 | V _{ac} |
| Forward Current | I _F | 15 | 20 | 25 | mA |
| Peak On-State Current | I _{TP} | — | — | 1 | A |
| Operating Temperature | T _{opr} | -25 | — | 85 | °C |

INDIVIDUAL ELECTRICAL CHARACTERISTICS (Ta = 25°C)

| CHARACTERISTIC | | SYMBOL | TEST CONDITION | MIN. | TYP. | MAX. | UNIT |
|----------------|--|-------------|--|------|------|------|------------------------|
| LED | Forward Voltage | V_F | $I_F = 10\text{mA}$ | 1.0 | 1.15 | 1.3 | V |
| | Reverse Current | I_R | $V_R = 5\text{V}$ | — | — | 10 | μA |
| | Capacitance | C_T | $V = 0, f = 1\text{MHz}$ | — | 30 | — | pF |
| DETECTOR | Peak Off-State Current | I_{DRM} | $V_{DRM} = 600\text{V}$ | — | 10 | 1000 | nA |
| | Peak On-State Voltage | V_{TM} | $I_{TM} = 100\text{mA}$ | — | 1.7 | 3.0 | V |
| | Holding Current | I_H | — | — | 0.6 | — | mA |
| | Critical Rate of Rise of Off-State Voltage | dv/dt | $V_{in} = 240\text{V}, T_a = 85^\circ\text{C}$ | — | 500 | — | $\text{V}/\mu\text{s}$ |
| | Critical Rate of Rise of Commutating Voltage | $dv/dt (C)$ | $I_T = 15\text{mA}$ $V_{in} = 60\text{V}_{rms}$ | — | 0.2 | — | $\text{V}/\mu\text{s}$ |

COUPLED ELECTRICAL CHARACTERISTICS (Ta = 25°C)

| CHARACTERISTIC | SYMBOL | TEST CONDITION | MIN. | TYP. | MAX. | UNIT |
|-------------------------------|----------|----------------------------|--------------------|-----------|------|-----------|
| Trigger LED Current | I_{FT} | $V_T = 6\text{V}$ | — | — | 10 | mA |
| Capacitance (Input to Output) | C_S | $V_S = 0, f = 1\text{MHz}$ | — | 0.8 | — | pF |
| Isolation Resistance | R_S | $V_S = 500\text{V}$ | 1×10^{12} | 10^{14} | — | Ω |
| Isolation Voltage | BV_S | AC, 1 minute | 4000 | — | — | V_{rms} |
| | | AC, 1 second, in oil | — | 10000 | — | |
| | | DC, 1 minute, in oil | — | 10000 | — | V_{dc} |

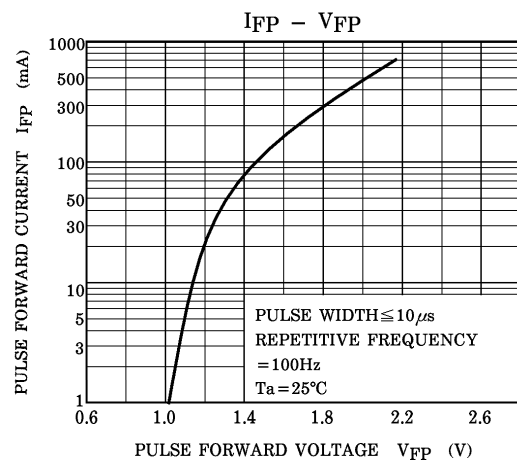
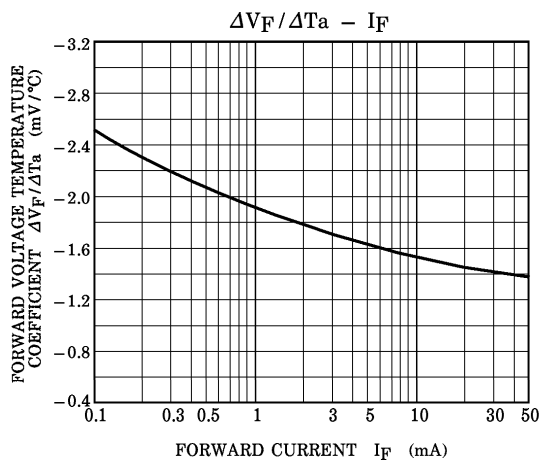
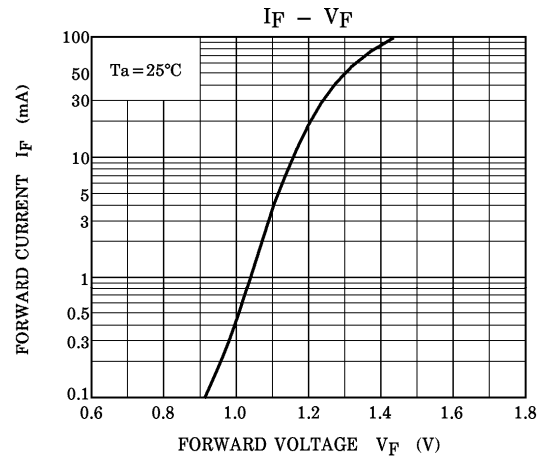
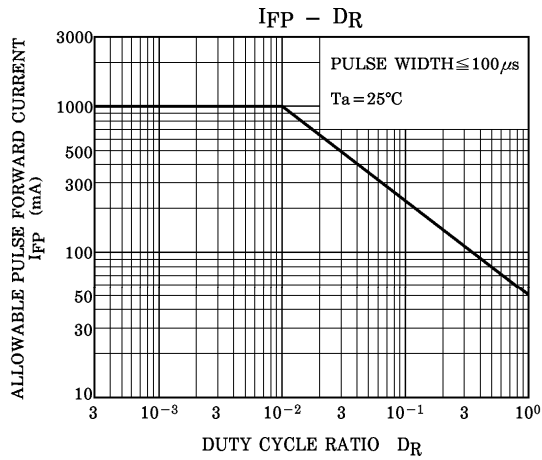
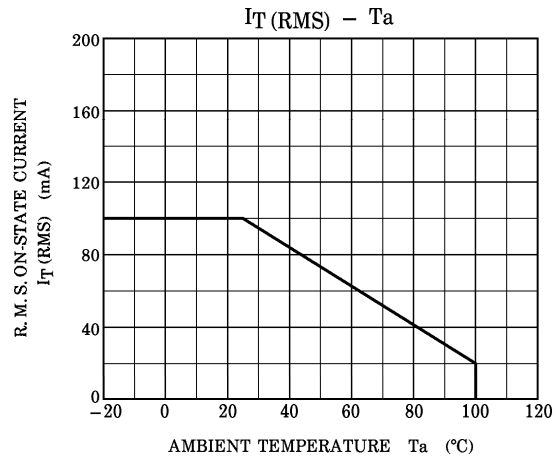
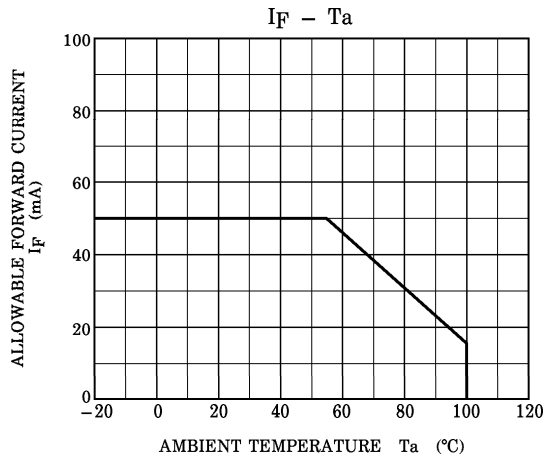

RESTRICTIONS ON PRODUCT USE

000707EAA

- TOSHIBA is continually working to improve the quality and reliability of its products. Nevertheless, semiconductor devices in general can malfunction or fail due to their inherent electrical sensitivity and vulnerability to physical stress. It is the responsibility of the buyer, when utilizing TOSHIBA products, to comply with the standards of safety in making a safe design for the entire system, and to avoid situations in which a malfunction or failure of such TOSHIBA products could cause loss of human life, bodily injury or damage to property. In developing your designs, please ensure that TOSHIBA products are used within specified operating ranges as set forth in the most recent TOSHIBA products specifications. Also, please keep in mind the precautions and conditions set forth in the "Handling Guide for Semiconductor Devices," or "TOSHIBA Semiconductor Reliability Handbook" etc..
- The TOSHIBA products listed in this document are intended for usage in general electronics applications (computer, personal equipment, office equipment, measuring equipment, industrial robotics, domestic appliances, etc.). These TOSHIBA products are neither intended nor warranted for usage in equipment that requires extraordinarily high quality and/or reliability or a malfunction or failure of which may cause loss of human life or bodily injury ("Unintended Usage"). Unintended Usage include atomic energy control instruments, airplane or spaceship instruments, transportation instruments, traffic signal instruments, combustion control instruments, medical instruments, all types of safety devices, etc.. Unintended Usage of TOSHIBA products listed in this document shall be made at the customer's own risk.
- The information contained herein is presented only as a guide for the applications of our products. No responsibility is assumed by TOSHIBA CORPORATION for any infringements of intellectual property or other rights of the third parties which may result from its use. No license is granted by implication or otherwise under any intellectual property or other rights of TOSHIBA CORPORATION or others.
- The information contained herein is subject to change without notice.