

ASSP for Image Processing

CMOS

A/D Converter (1-channel, 8-bit, 20MHz)

MB40C568

DESCRIPTION

The MB40C568 is a high-speed A/D converter using high-speed CMOS process technology.

FEATURES

- Resolution: 8 bits
- Linearity error: $\pm 0.20\%$ (Typ.)
- Maximum conversion rate: 20 MSPS (Min.)
- Power supply voltage: Analog section +5.0 V
Digital section +3.0 V or +5.0 V
- Digital input voltage range: TTL level
- Digital output voltage range: CMOS level compatible
- Analog input voltage range: 0.5 to 4 V (with 2 V_{p-p})
- Analog input capacity: 15 pF (Typ.)
- Power consumption: 50 mW (Typical: @f_{CLK} = 20 MHz, AV_{DD} = 5 V, DV_{DD} = 3 V)
60 mW (Typical: @f_{CLK} = 20 MHz, AV_{DD} = DV_{DD} = 5 V)
- Additional function: Reference voltage generator circuit: V_{REFT} = 3 V, V_{REFB} = 1 V
- Package options: SOP24, SSOP24

PACKAGES

24-pin, Plastic SOP

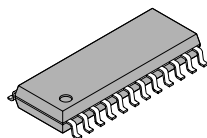

(FPT-24P-M01)

24-pin, Plastic SSOP

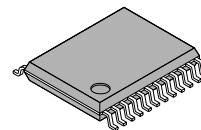

(FPT-24P-M03)

This device contains circuitry to protect the inputs against damage due to high static voltages or electric fields. However, it is advised that normal precautions be taken to avoid application of any voltage higher than maximum rated voltages to this high impedance circuit.

■ PIN ASSIGNMENT

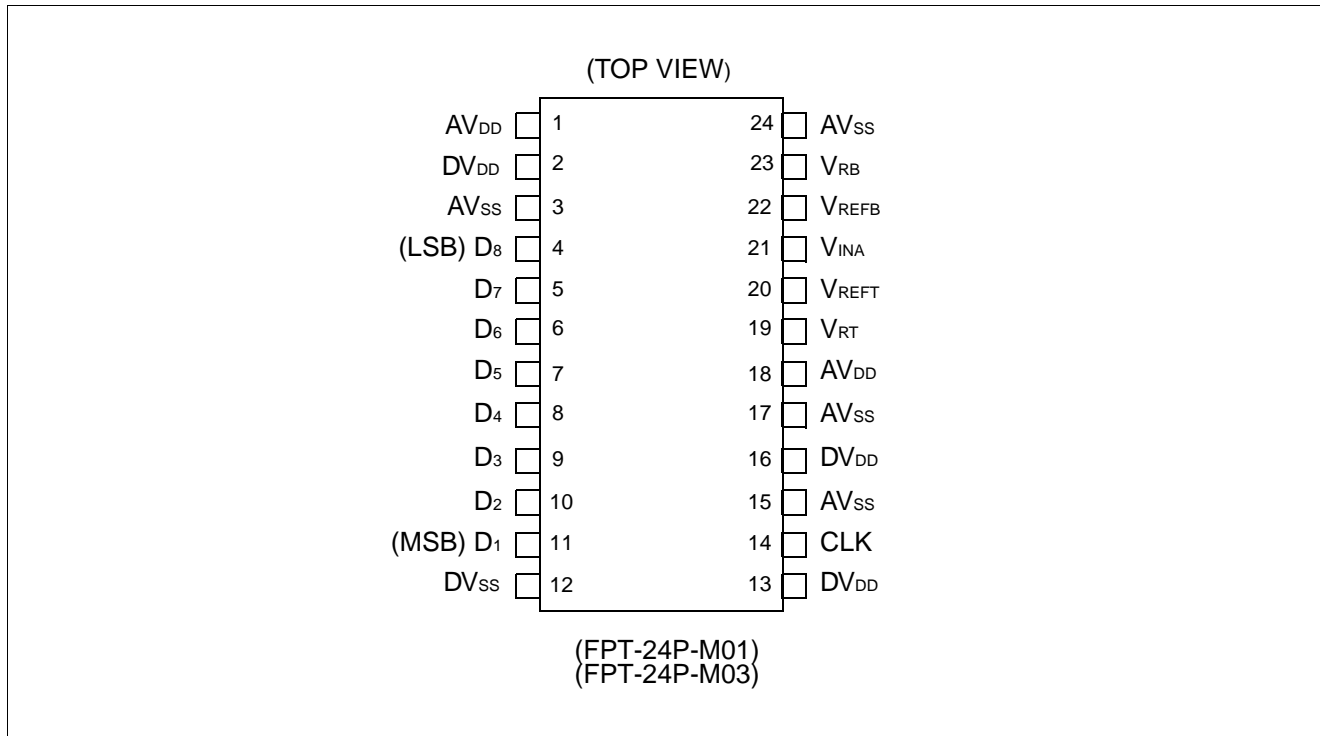

■ PIN DESCRIPTION

Pin No.	Pin name	Functions
1, 18	AV _{DD}	Analog power supply pins (+5 V)
2, 13, 16	DV _{DD}	Digital power supply pins (+3 or +5 V)
3, 15, 17, 24	AV _{SS}	Analog power ground pins (0 V)
12	DV _{SS}	Digital power ground pin (0 V)
4 to 11	D ₁ to D ₈	Digital output pins. D ₁ : MSB, D ₈ : LSB
14	CLK	Clock input pin
21	V _{INA}	Analog input pin. Input range: V _{RB} to V _{RT} (2 V _{p-p} between 0.5 to 4 V)
19	V _{RT}	Reference voltage input pin (3 V)
20	V _{REFT}	Reference voltage output pin. When connected to V _{RT} , the pin generates 0.6 × AV _{DD} (3 V).
23	V _{RB}	Reference voltage input pin (1 V)
22	V _{REFB}	Reference voltage output pin. When connected to V _{RB} , the pin generates 0.2 × AV _{DD} (1 V).

Values within () are typical values.

■ NOTES ON USE

- Be sure to bypass the AV_{DD}, DV_{DD}, V_{RT} and V_{RB} pins to the ground using a high-frequency capacitor. The high-frequency capacitor should be connected as near the pin as possible.
- Provide four clocks or more immediately after the power up to prevent current dissipation due to the indeterminate internal logic.

■ ABSOLUTE MAXIMUM RATINGS (See WARNING)

Parameter	Symbol	Rating		Unit
		Min.	Max.	
Power supply voltage	AV_{DD}, DV_{DD}	-0.3	7.0	V
Input voltage	CLK, V_{INA} V_{RT}, V_{RB}	-0.3	$AV_{DD}+0.3$	V
Output voltage	D_1 to D_8	-0.3	$DV_{DD}+0.3$	V
Storage temperature	Tstg	-55	+125	°C

WARNING: Semiconductor devices can be permanently damaged by application of stress (voltage, current, temperature, etc.) in excess of absolute maximum ratings. Do not exceed these ratings.

■ RECOMMENDED OPERATING CONDITIONS

Parameter	Symbol	Value			Unit
		Min.	Typ.	Max.	
Analog input voltage	V_{INA}	V_{RB}	–	V_{RT}	V
Analog reference voltage: T	V_{RT}	–	–	4.00	V
Analog reference voltage: B	V_{RB}	0.50	–	–	V
Analog reference voltage range	$V_{RT}-V_{RB}$	1.90	2.00	2.10	V
Digital "H" level input voltage	V_{IHD}	2.4	–	–	V
Digital "L" level input voltage	V_{ILD}	–	–	0.8	V
Digital input current	I_{ID}	–	–	5	μA
Clock frequency	f_{CLK}	0.1	–	20	MHz
Minimum "H" level clock pulse width	tw^+	22.5	–	–	ns
Minimum "L" level clock pulse width	tw^-	22.5	–	–	ns
Operating temperature range	T_a	-20	–	70	°C

WARNING: Recommended operating conditions are normal operating ranges for the semiconductor device. All the device's electrical characteristics are warranted when operated within these ranges.

Always use semiconductor devices within the recommended operating conditions. Operation outside these ranges may adversely affect reliability and could result in device failure.

No warranty is made with respect to uses, operating conditions, or combinations not represented on the data sheet. Users considering application outside the listed conditions are advised to contact their FUJITSU representative beforehand.

(Continued)

MB40C568

(Continued)

- When using a single power supply

Parameter	Symbol	Value			Unit
		Min.	Typ.	Max.	
Power supply voltage	AV_{DD}, DV_{DD}	4.75	5.00	5.25	V

- When using dual power supplies

Parameter	Symbol	Value			Unit
		Min.	Typ.	Max.	
Power supply voltage	AV_{DD}	4.75	5.00	5.25	V
	DV_{DD}	2.70	3.00	3.30	V

WARNING: Recommended operating conditions are normal operating ranges for the semiconductor device. All the device's electrical characteristics are warranted when operated within these ranges.

Always use semiconductor devices within the recommended operating conditions. Operation outside these ranges may adversely affect reliability and could result in device failure.

No warranty is made with respect to uses, operating conditions, or combinations not represented on the data sheet. Users considering application outside the listed conditions are advised to contact their FUJITSU representative beforehand.

■ ELECTRICAL CHARACTERISTICS (Using a Single Power Supply)

DC Characteristics

(1) Analog section

($AV_{DD} = DV_{DD} = 4.75\text{ V to }+5.25\text{ V}$, $T_a = -20^\circ\text{C to }+70^\circ\text{C}$)

Parameter	Symbol	Value			Unit
		Min.	Typ.	Max.	
Resolution	–	–	8	–	bit
Linearity error	DC precision	LE	±0.20	±0.30	%
Differential linearity error		DLE	–	±0.12	±0.20
Analog input capacity	C_{INA}	–	15	–	pF
Reference voltage: T	V_{REFT}	–	$0.6 \times AV_{DD}$	–	V
Reference voltage: B	V_{REFB}	–	$0.2 \times AV_{DD}$	–	V
Reference current	I_{RB}	–16.0	–8.0	–2.0	mA
Analog power supply current	I_{DD}	–	8.0	14.0	mA
Digital power supply current	D_{DD}	–	4.0	7.0	mA

(2) Digital section

($AV_{DD} = DV_{DD} = 4.75\text{ V to }+5.25\text{ V}$, $T_a = -20^\circ\text{C to }+70^\circ\text{C}$)

Parameter	Symbol	Value			Unit
		Min.	Typ.	Max.	
Digital "H" level output voltage	V_{OHD}	4.2	–	DV_{DD}	V
Digital "L" level output voltage	V_{OLD}	–	–	0.4	V
Digital "H" level output current	I_{OH}	–400	–	–	μA
Digital "L" level output current	I_{OL}	–	–	1.6	mA

(3) Switching section

($AV_{DD} = DV_{DD} = 4.75\text{ V to }+5.25\text{ V}$, $T_a = -20^\circ\text{C to }+70^\circ\text{C}$)

Parameter	Symbol	Value			Unit
		Min.	Typ.	Max.	
Maximum conversion rate	fs	20	–	–	MSPS
Digital output delay time	tpd	0	5	20	ns

■ ELECTRICAL CHARACTERISTICS (Using Dual Power Supplies)

DC Characteristics

(1) Analog section

($AV_{DD} = 4.75\text{ V to }+5.25\text{ V}$, $DV_{DD} = 2.70\text{ V to }+3.30\text{ V}$ $T_a = -20^\circ\text{C to }+70^\circ\text{C}$)

Parameter	Symbol	Value			Unit
		Min.	Typ.	Max.	
Resolution	–	–	8	–	bit
Linearity error	DC precision	LE	±0.20	±0.30	%
Differential linearity error		DLE	±0.12	±0.20	%
Analog input capacity	C_{INA}	–	15	–	pF
Reference voltage: T	V_{REFT}	–	$0.6 \times AV_{DD}$	–	V
Reference voltage: B	V_{REFB}	–	$0.2 \times AV_{DD}$	–	V
Reference current	I_{RB}	–16.0	–8.0	–2.0	mA
Analog power supply current	AI_{DD}	–	8.0	14.0	mA
Digital power supply current	DI_{DD}	–	3.0	5.0	mA

(2) Digital section

($AV_{DD} = 4.75\text{ V to }+5.25\text{ V}$, $DV_{DD} = 2.70\text{ V to }+3.30\text{ V}$ $T_a = -20^\circ\text{C to }+70^\circ\text{C}$)

Parameter	Symbol	Value			Unit
		Min.	Typ.	Max.	
Digital "H" level output voltage	V_{OHD}	2.4	–	DV_{DD}	V
Digital "L" level output voltage	V_{OLD}	–	–	0.4	V
Digital "H" level output current	I_{OH}	–400	–	–	μA
Digital "L" level output current	I_{OL}	–	–	1.6	mA

(3) Switching section

($AV_{DD} = 4.75\text{ V to }+5.25\text{ V}$, $DV_{DD} = 2.70\text{ V to }+3.30\text{ V}$ $T_a = -20^\circ\text{C to }+70^\circ\text{C}$)

Parameter	Symbol	Value			Unit
		Min.	Typ.	Max.	
Maximum conversion rate	fs	20	–	–	MSPS
Digital output delay time	tpd	0	6	25	ns

■ EQUIVALENT CIRCUIT

• Clock input

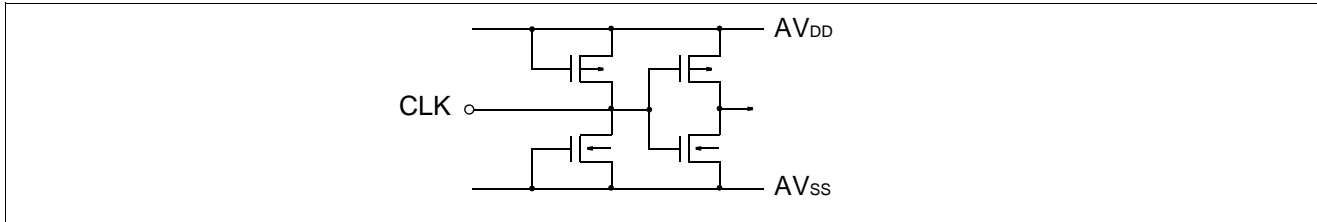

• Analog input

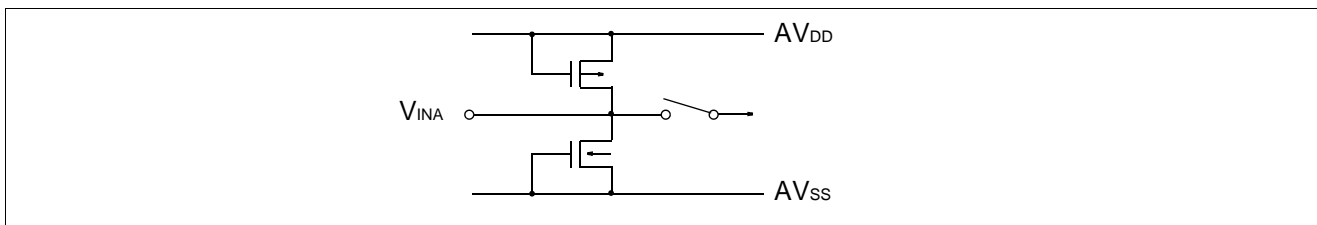

• Reference voltage input

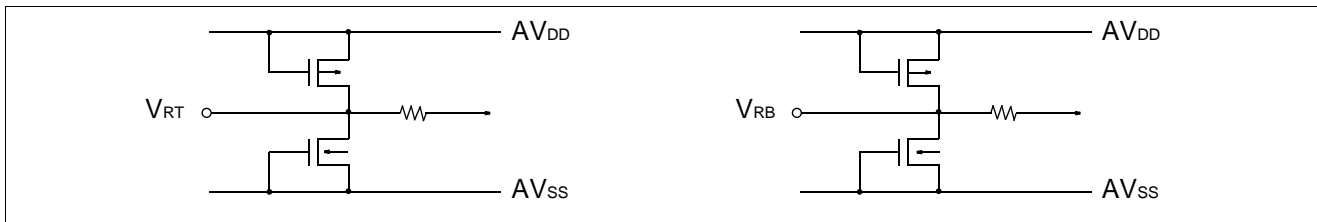

• Reference voltage output

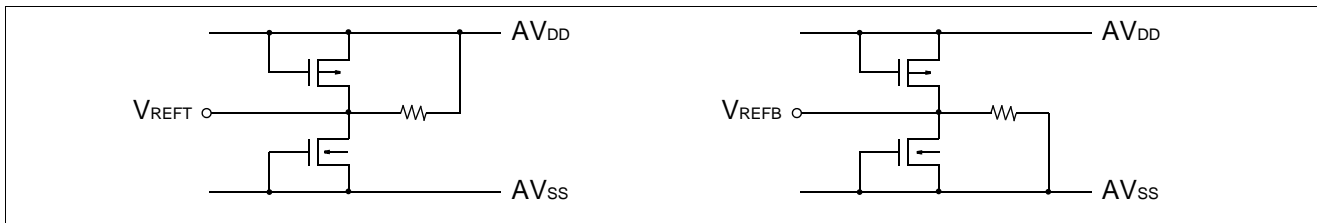

• Digital output

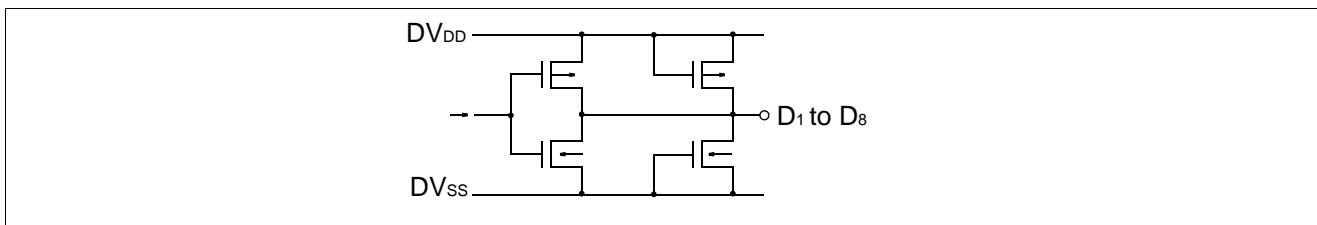

■ TIMING CHART

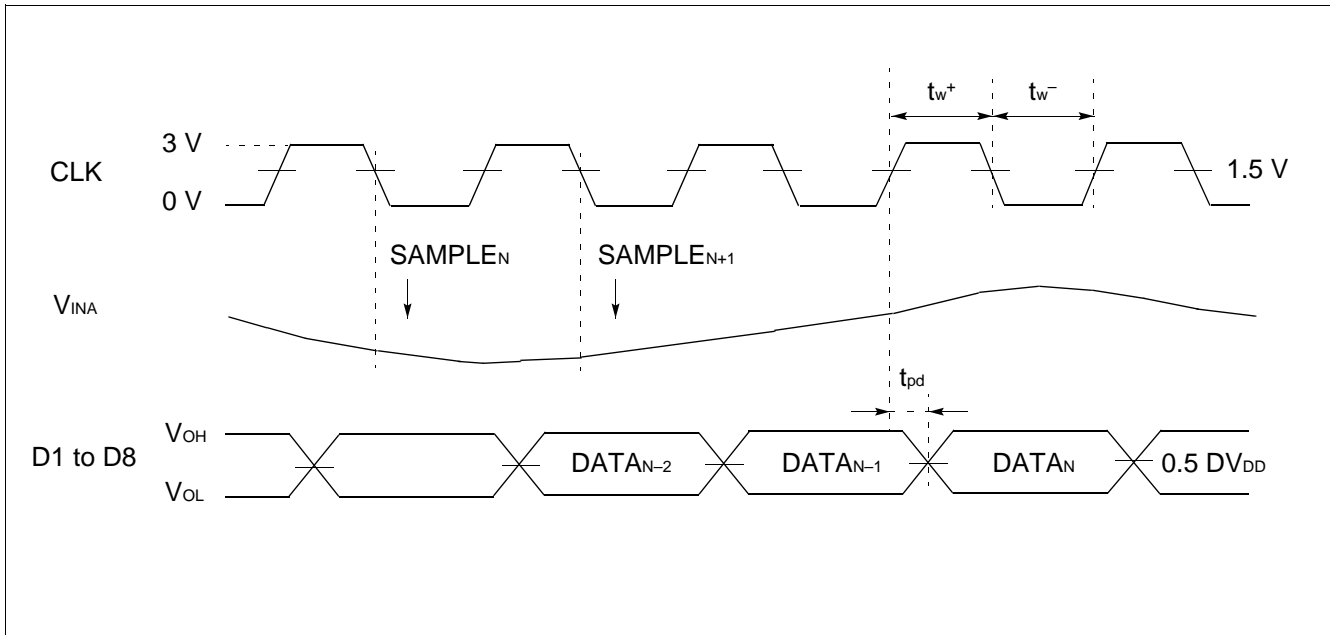

■ DIGITAL OUTPUT BUFFER LOAD CIRCUIT

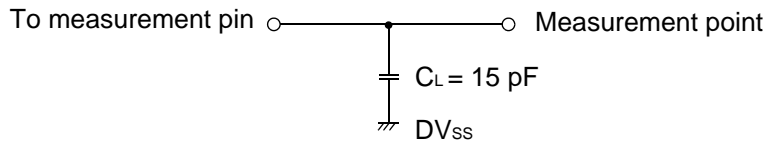

(Note) C_L value includes the floating capacitance of the jig and probe.

■ ORDERING INFORMATION

Part number	Package	Remarks
MB40C568PF	24-pin, Plastic SOP (FPT-24P-M01)	
MB40C568PFV	24-pin, Plastic SSOP (FPT-24P-M03)	

MB40C568

■ PACKAGE DIMENSIONS

24-pin, Plastic SOP
(FPT-24P-M01)

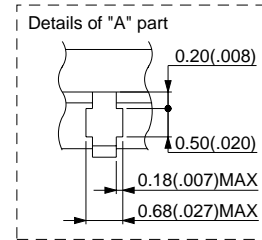
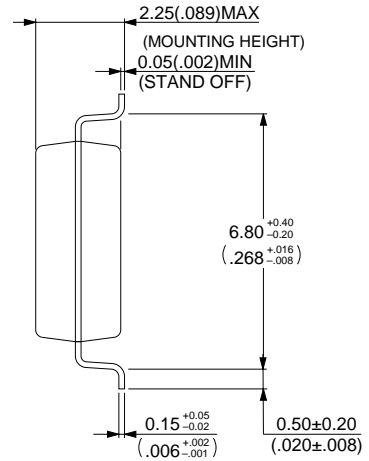
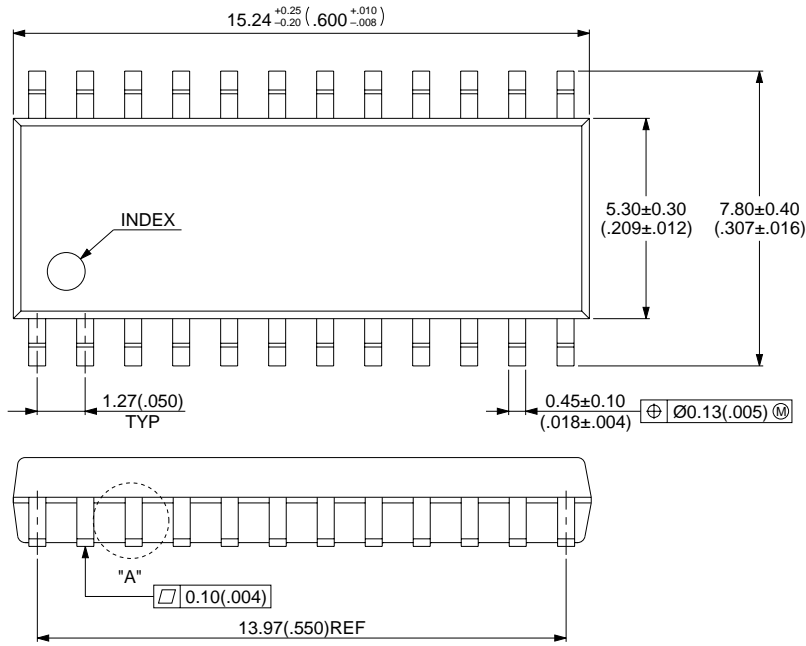

© 1994 FUJITSU LIMITED F24007S-3C-4

Dimensions in mm (inches).

(Continued)

(Continued)

24-pin, Plastic SSOP
(FPT-24P-M03)

*: These dimensions do not include resin protrusion.

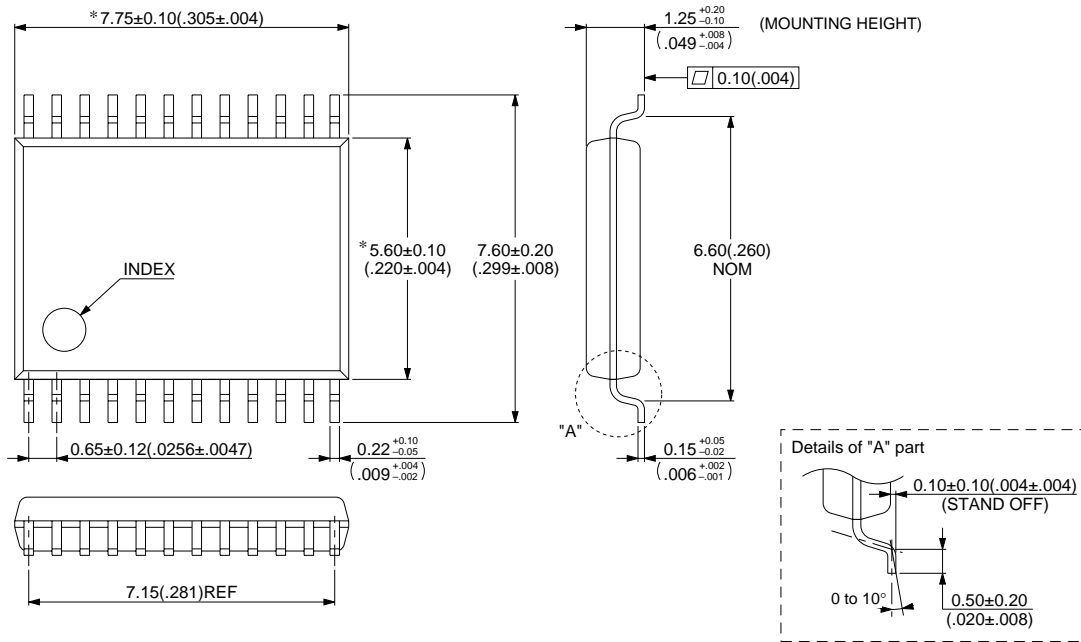

© 1994 FUJITSU LIMITED F24018S-2C-2

Dimensions in mm (inches).

FUJITSU LIMITED

For further information please contact:

Japan

FUJITSU LIMITED
Corporate Global Business Support Division
Electronic Devices
KAWASAKI PLANT, 4-1-1, Kamikodanaka
Nakahara-ku, Kawasaki-shi
Kanagawa 211-88, Japan
Tel: (044) 754-3763
Fax: (044) 754-3329

North and South America

FUJITSU MICROELECTRONICS, INC.
Semiconductor Division
3545 North First Street
San Jose, CA 95134-1804, U.S.A.
Tel: (408) 922-9000
Fax: (408) 432-9044/9045

Europe

FUJITSU MIKROELEKTRONIK GmbH
Am Siebenstein 6-10
63303 Dreieich-Buchsschlag
Germany
Tel: (06103) 690-0
Fax: (06103) 690-122

Asia Pacific

FUJITSU MICROELECTRONICS ASIA PTE. LIMITED
#05-08, 151 Lorong Chuan
New Tech Park
Singapore 556741
Tel: (65) 281-0770
Fax: (65) 281-0220

F9703

© FUJITSU LIMITED Printed in Japan

All Rights Reserved.

The contents of this document are subject to change without notice. Customers are advised to consult with FUJITSU sales representatives before ordering.

The information and circuit diagrams in this document presented as examples of semiconductor device applications, and are not intended to be incorporated in devices for actual use. Also, FUJITSU is unable to assume responsibility for infringement of any patent rights or other rights of third parties arising from the use of this information or circuit diagrams.

FUJITSU semiconductor devices are intended for use in standard applications (computers, office automation and other office equipment, industrial, communications, and measurement equipment, personal or household devices, etc.).

CAUTION:

Customers considering the use of our products in special applications where failure or abnormal operation may directly affect human lives or cause physical injury or property damage, or where extremely high levels of reliability are demanded (such as aerospace systems, atomic energy controls, sea floor repeaters, vehicle operating controls, medical devices for life support, etc.) are requested to consult with FUJITSU sales representatives before such use. The company will not be responsible for damages arising from such use without prior approval.

Any semiconductor devices have inherently a certain rate of failure. You must protect against injury, damage or loss from such failures by incorporating safety design measures into your facility and equipment such as redundancy, fire protection, and prevention of over-current levels and other abnormal operating conditions.

If any products described in this document represent goods or technologies subject to certain restrictions on export under the Foreign Exchange and Foreign Trade Control Law of Japan, the prior authorization by Japanese government should be required for export of those products from Japan.

***DS04-2820'**