

## High Voltage Transistor

### FEATURE

- We declare that the material of product compliance with RoHS requirements.

### DEVICE MARKING AND ORDERING INFORMATION

Device	Marking	Shipping
LMBT5401LT1G	2L	3000/Tape&Reel
LMBT5401LT3G	2L	10000/Tape&Reel

### MAXIMUM RATINGS

Rating	Symbol	Value	Unit
Collector–Emitter Voltage	$V_{CEO}$	- 150	Vdc
Collector–Base Voltage	$V_{CBO}$	- 160	Vdc
Emitter–Base Voltage	$V_{EBO}$	- 5.0	Vdc
Collector Current — Continuous	$I_C$	- 500	mAdc

### THERMAL CHARACTERISTICS

Characteristic	Symbol	Max	Unit
Total Device Dissipation FR- 5 Board (1) $T_A=25^\circ\text{C}$ Derate above $25^\circ\text{C}$	$P_D$	225	mW
		1.8	mW/°C
Thermal Resistance, Junction to Ambient	$R_{\theta JA}$	556	°C/W
Total Device Dissipation Alumina Substrate, (2) $T_A = 25^\circ\text{C}$ Derate above $25^\circ\text{C}$	$P_D$	300	mW
		2.4	mW/°C
Thermal Resistance, Junction to Ambient	$R_{\theta JA}$	417	°C/W
Junction and Storage Temperature	$T_{J}, T_{stg}$	-55to+150	°C

### DEVICE MARKING

LMBT5401LT1G=2L
-----------------

### ELECTRICAL CHARACTERISTICS ( $T_A = 25^\circ\text{C}$ unless otherwise noted)

Characteristic	Symbol	Min	Max	Unit
----------------	--------	-----	-----	------

### OFF CHARACTERISTICS

Collector–Emitter Breakdown Voltage ( $I_C = -1.0\text{ mAdc}, I_E = 0$ )	$V_{(BR)CEO}$	- 150	—	Vdc
Collector–Base Breakdown Voltage ( $I_C = -100\ \mu\text{Adc}, I_E = 0$ )	$V_{(BR)CBO}$	- 160	—	Vdc
Emitter–Base Breakdown Voltage ( $I_E = -10\ \mu\text{Adc}, I_C = 0$ )	$V_{(BR)EBO}$	-5.0	—	Vdc
Collector Cutoff Current ( $V_{CB} = -120\text{ Vdc}, I_E = 0$ )	$I_{CBO}$	—	- 50	nAdc
( $V_{CB} = -120\text{ Vdc}, I_E = 0, T_A = 100^\circ\text{C}$ )		—	- 50	$\mu\text{Adc}$

1. FR-5 = 1.0 x 0.75 x 0.062 in.

2. Alumina = 0.4 x 0.3 x 0.024 in. 99.5% alumina.

### LMBT5401LT1G

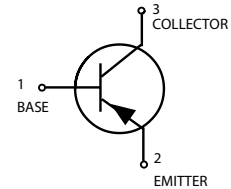
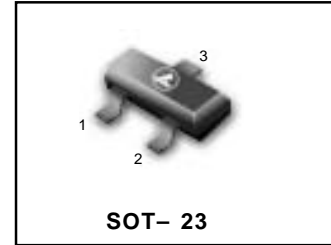

**LMBT5401LT1G**
**ELECTRICAL CHARACTERISTICS** ( $T_A = 25^\circ\text{C}$  unless otherwise noted) (Continued)

Characteristic	Symbol	Min	Max	Unit
<b>ON CHARACTERISTICS (2)</b>				
DC Current Gain ( $I_C = -1.0\text{mA}$ , $V_{CE} = -5.0\text{Vdc}$ )	$h_{FE}$	50	—	—
( $I_C = -10\text{mA}$ , $V_{CE} = -5.0\text{Vdc}$ )		60	240	
( $I_C = -50\text{mA}$ , $V_{CE} = -5.0\text{Vdc}$ )		50	—	
Collector–Emitter Saturation Voltage ( $I_C = -10\text{mA}$ , $I_B = -1.0\text{mA}$ )	$V_{CE(sat)}$	—	-0.2	Vdc
( $I_C = -50\text{mA}$ , $I_B = -5.0\text{mA}$ )		—	-0.5	
Base–Emitter Saturation Voltage ( $I_C = -10\text{mA}$ , $I_B = -1.0\text{mA}$ )	$V_{BE(sat)}$	—	-1.0	Vdc
( $I_C = -50\text{mA}$ , $I_B = -5.0\text{mA}$ )		—	-1.0	
<b>SMALL–SIGNAL CHARACTERISTICS</b>				
Current–Gain — Bandwidth Product ( $I_C = -10\text{mA}$ , $V_{CE} = -10\text{Vdc}$ , $f = 100\text{MHz}$ )	$f_T$	100	300	MHz
Output Capacitance ( $V_{CB} = -10\text{Vdc}$ , $I_E = 0$ , $f = 1.0\text{MHz}$ )	$C_{obo}$	—	6.0	pF
Small–Signal Current Gain ( $I_C = -1.0\text{mA}$ , $V_{CE} = -10\text{Vdc}$ , $f = 1.0\text{kHz}$ )	$h_{ie}$	40	200	—
Noise Figure ( $I_C = -200\mu\text{A}$ , $V_{CE} = -5.0\text{Vdc}$ , $R_s = 10\Omega$ , $f = 1.0\text{kHz}$ )	NF	—	8.0	dB

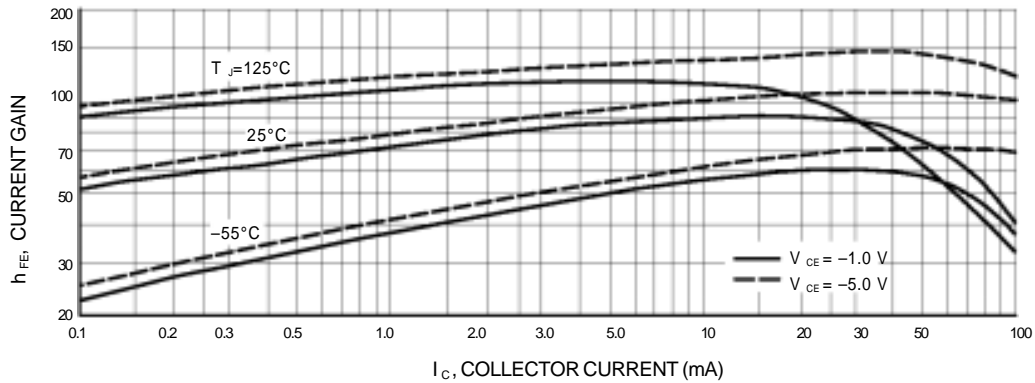
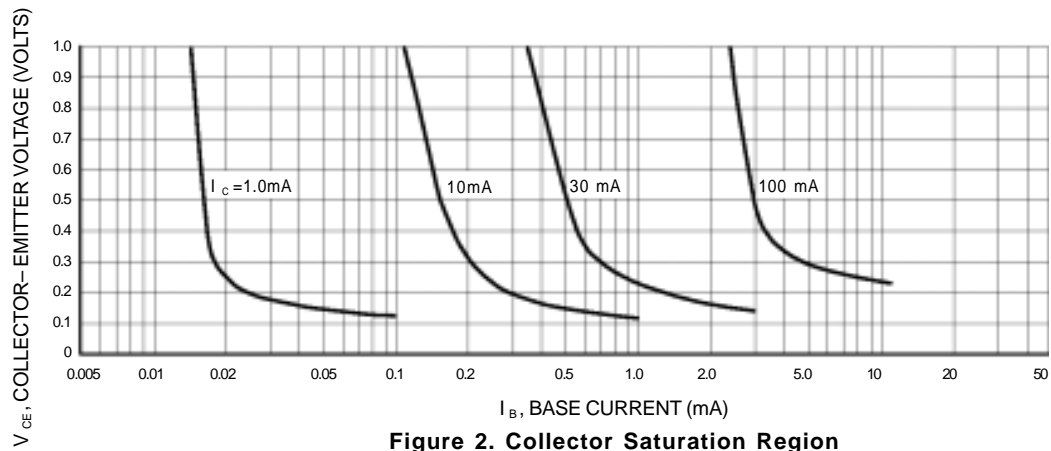
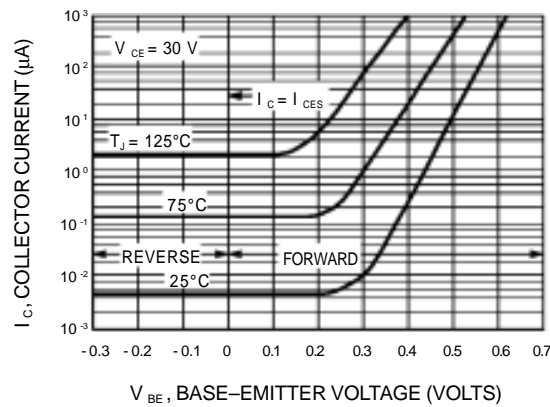
**LMBT5401LT1G**

**Figure 1. DC Current Gain**

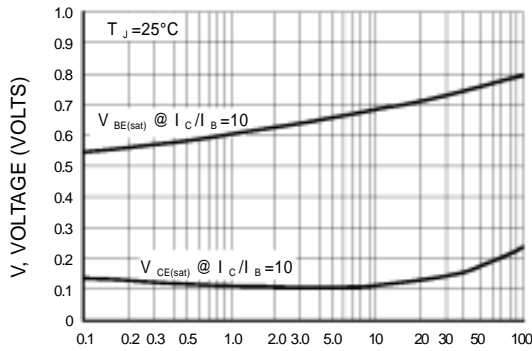
**Figure 2. Collector Saturation Region**

**Figure 3. Collector Cut-Off Region**

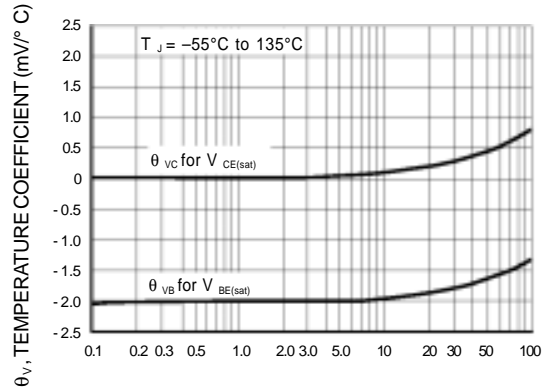
**LMBT5401LT1G**



**Figure 4. "On" Voltages**



**Figure 5. Temperature Coefficients**

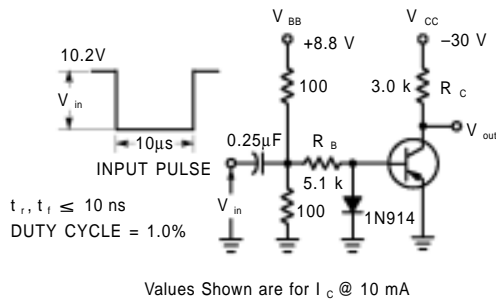

**Figure 6. Switching Time Test Circuit**

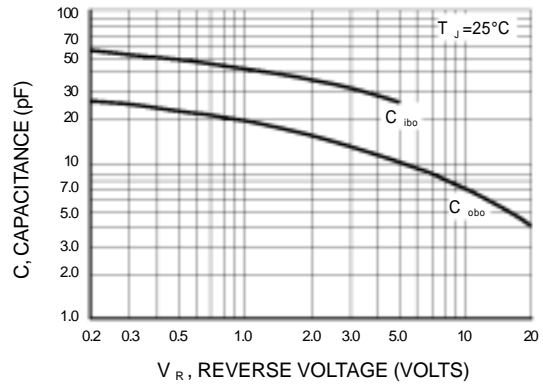

**Figure 7. Capacitances**

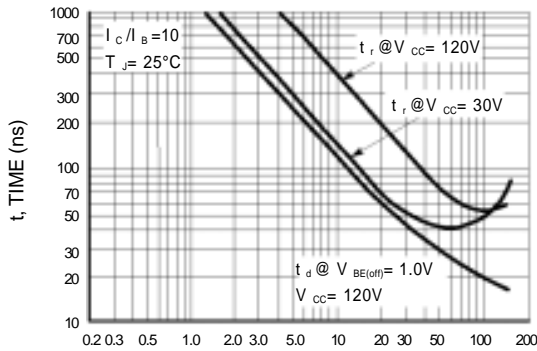

**Figure 8. Turn-On Time**

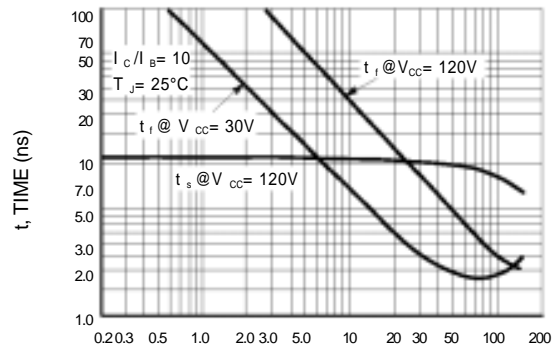

**Figure 9. Turn-Off Time**

**LMBT5401LT1G**

**SOT-23**

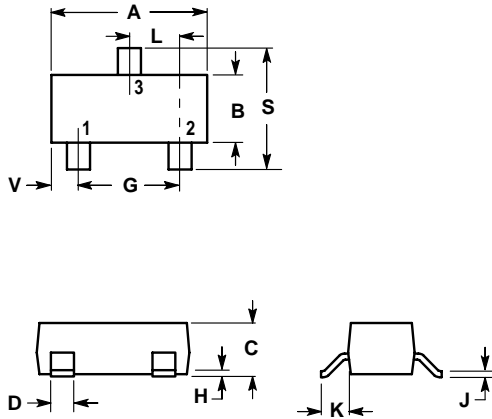

NOTES:

1. DIMENSIONING AND TOLERANCING PER ANSI Y14.5M, 1982.
2. CONTROLLING DIMENSION: INCH.

DIM	INCHES		MILLIMETERS	
	MIN	MAX	MIN	MAX
A	0.1102	0.1197	2.80	3.04
B	0.0472	0.0551	1.20	1.40
C	0.0350	0.0440	0.89	1.11
D	0.0150	0.0200	0.37	0.50
G	0.0701	0.0807	1.78	2.04
H	0.0005	0.0040	0.013	0.100
J	0.0034	0.0070	0.085	0.177
K	0.0140	0.0285	0.35	0.69
L	0.0350	0.0401	0.89	1.02
S	0.0830	0.1039	2.10	2.64
V	0.0177	0.0236	0.45	0.60

- PIN 1. BASE  
 2. EMITTER  
 3. COLLECTOR

