

SHINDENGEN

Switching Power Transistor

2SC4941

6A NPN

OUTLINE DIMENSIONS

Case : ITO-3P

Unit : mm

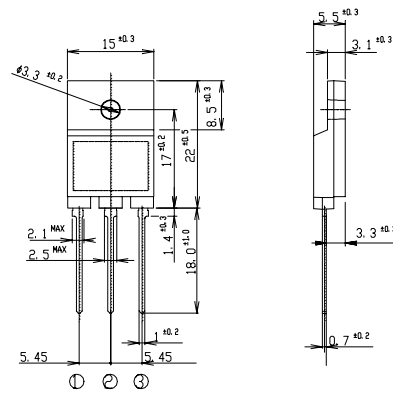

⊙: B
 ⊘: C
 ⊚: E

RATINGS

● Absolute Maximum Ratings

Item	Symbol	Conditions	Ratings	Unit
Storage Temperature	T _{stg}		-55~150	°C
Junction Temperature	T _j		150	°C
Collector to Base Voltage	V _{CB0}		1500	V
Collector to Emitter Voltage	V _{CEO}		800	V
Emitter to Base Voltage	V _{EBO}		7	V
Collector Current DC	I _C		6	A
Collector Current Peak	I _{CP}		12	
Base Current DC	I _B		3	A
Base Current Peak	I _{BP}		6	
Total Transistor Dissipation	P _T		65	W
Dielectric Strength	V _{dis}	Terminals to case, AC 1 minute	2	kV
Mounting Torque	TOR	(Recommended torque)	0.8(0.5)	N·m

● Electrical Characteristics (T_c=25°C)

Item	Symbol	Conditions	Ratings	Unit
Collector to Emitter Sustaining Voltage	V _{CEO(sus)}	I _C = 0.2A	Min 800	V
Collector to Base Voltage	V _{CB0}	I _{CB} = 1mA	Min 1500	
Collector Cutoff Current	I _{CBO}	V _{CB} = 1200V	Max 0.1	mA
	I _{CEO}	rated V _{CEO}	Max 0.1	
Emitter Cutoff Current	I _{EBO}	rated V _{EBO}	Max 0.1	mA
DC Current Gain	h _{FE}	V _{CE} = 5V, I _C = 1A	Min 15	
	h _{FEL}	V _{CE} = 5V, I _C = 1mA	Min 7	
Collector to Emitter Saturation Voltage	V _{CE(sat)}	I _C = 3A	Max 0.5	V
Base to Emitter Saturation Voltage	V _{BE(sat)}	I _B = 0.6A	Max 1.5	V
Thermal Resistance	θ _{jc}	Junction to case	Max 1.92	°C/W
Transition Frequency	f _T	V _{CE} = 10V, I _C = 0.6A	TYP 8	MHz
Turn on Time	ton	I _C = 3A	Max 0.5	μs
Storage Time	ts	I _{B1} = 0.6A, I _{B2} = 1.2A	Max 3.5	
Fall Time	tf	R _L = 85 Ω, V _{BB2} = 4V	Max 0.3	

2SC4941 $h_{FE} - I_C$

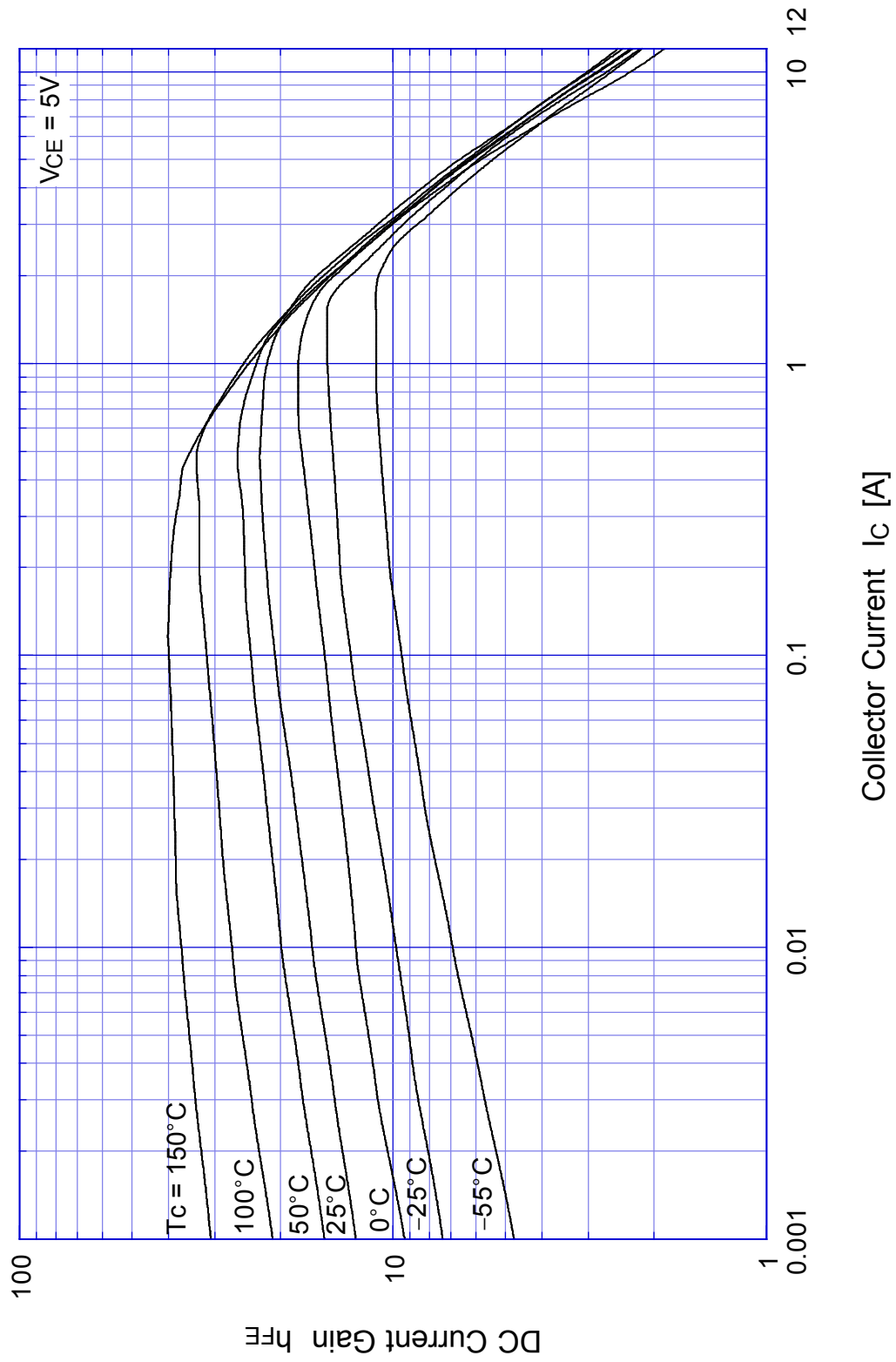

2SC4941 Saturation Voltage

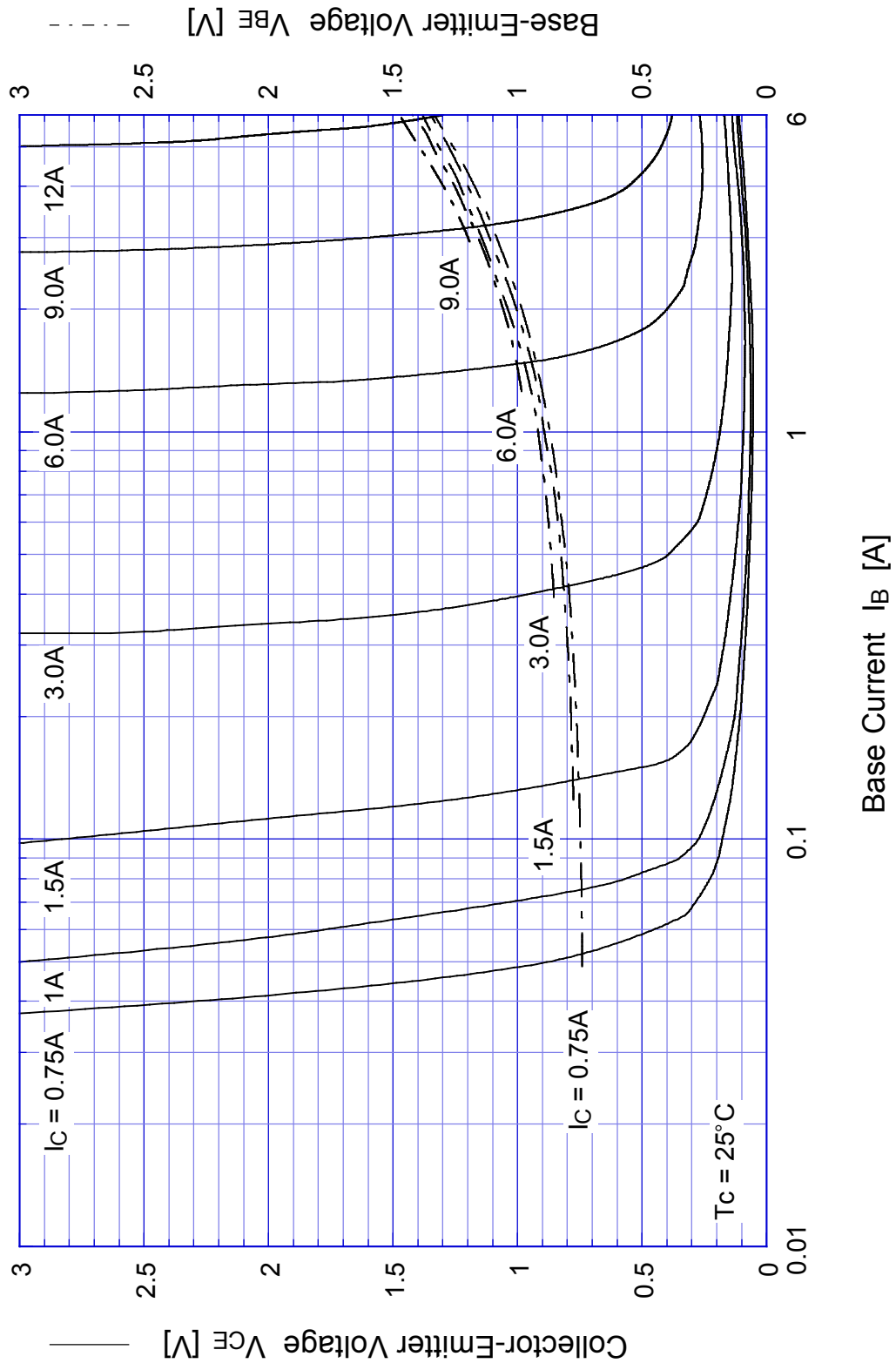

2SC4941

Switching Time - I_C

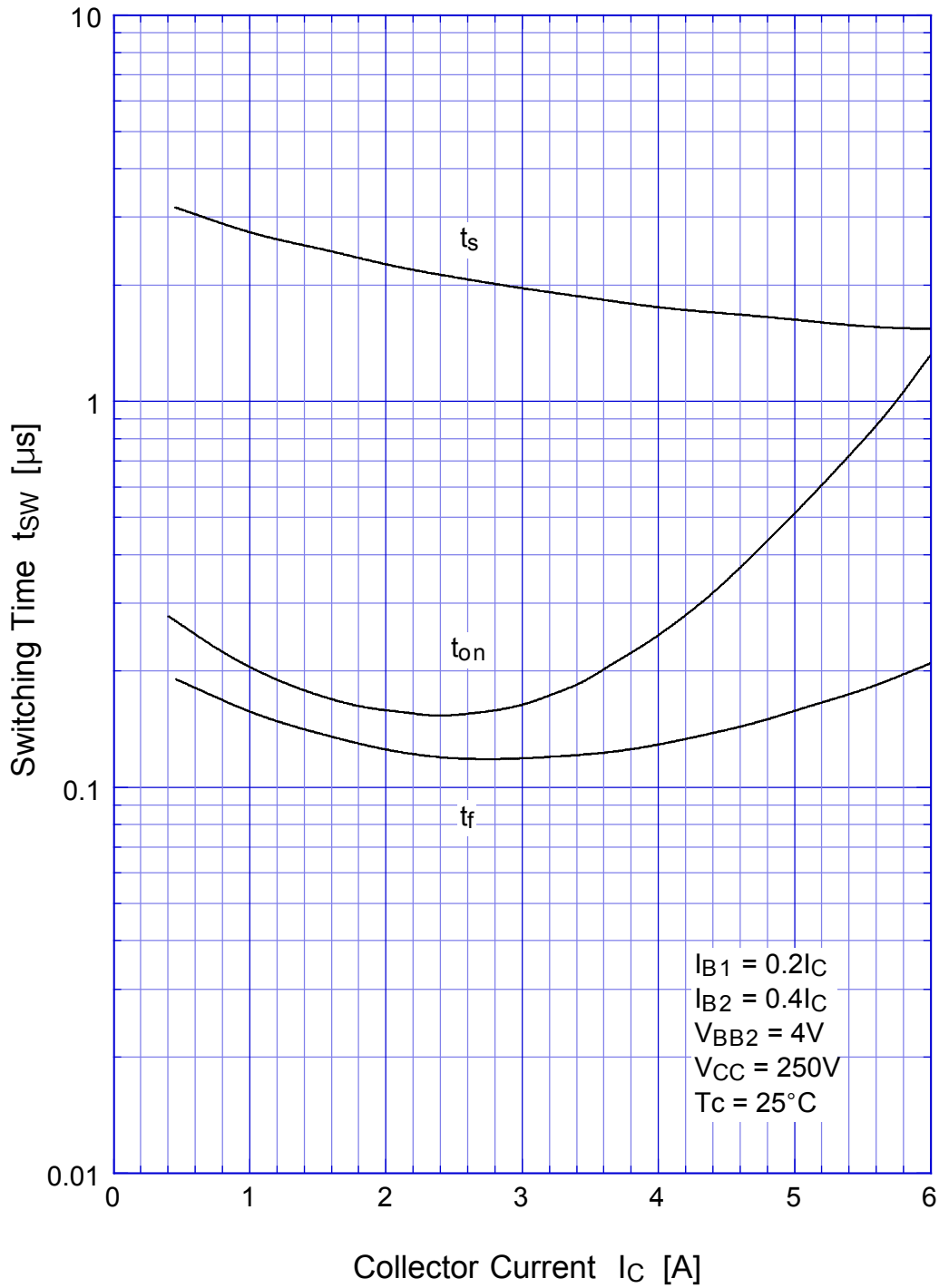

2SC4941 Switching Time - Tc

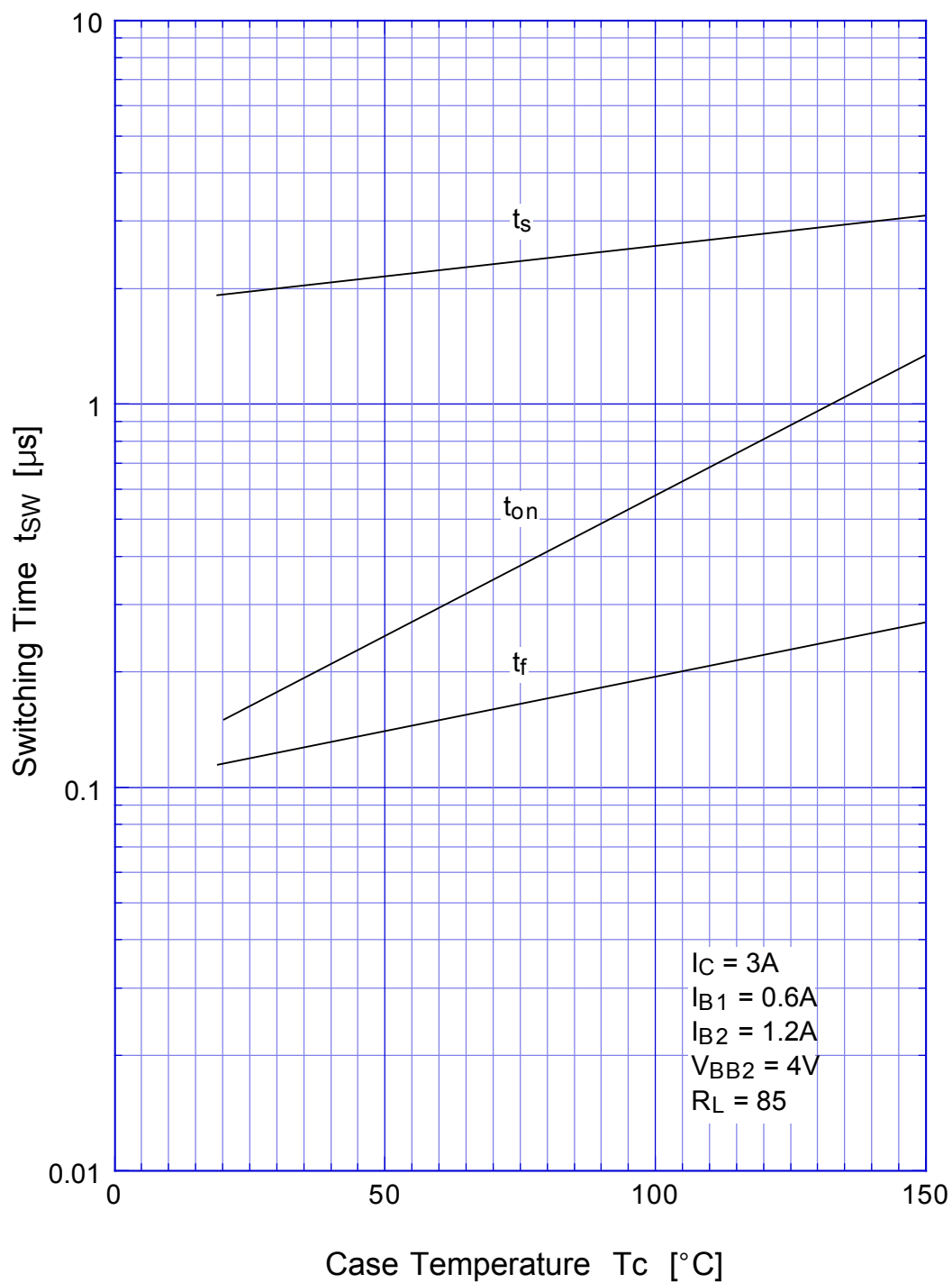

2SC4941 Forward Bias SOA

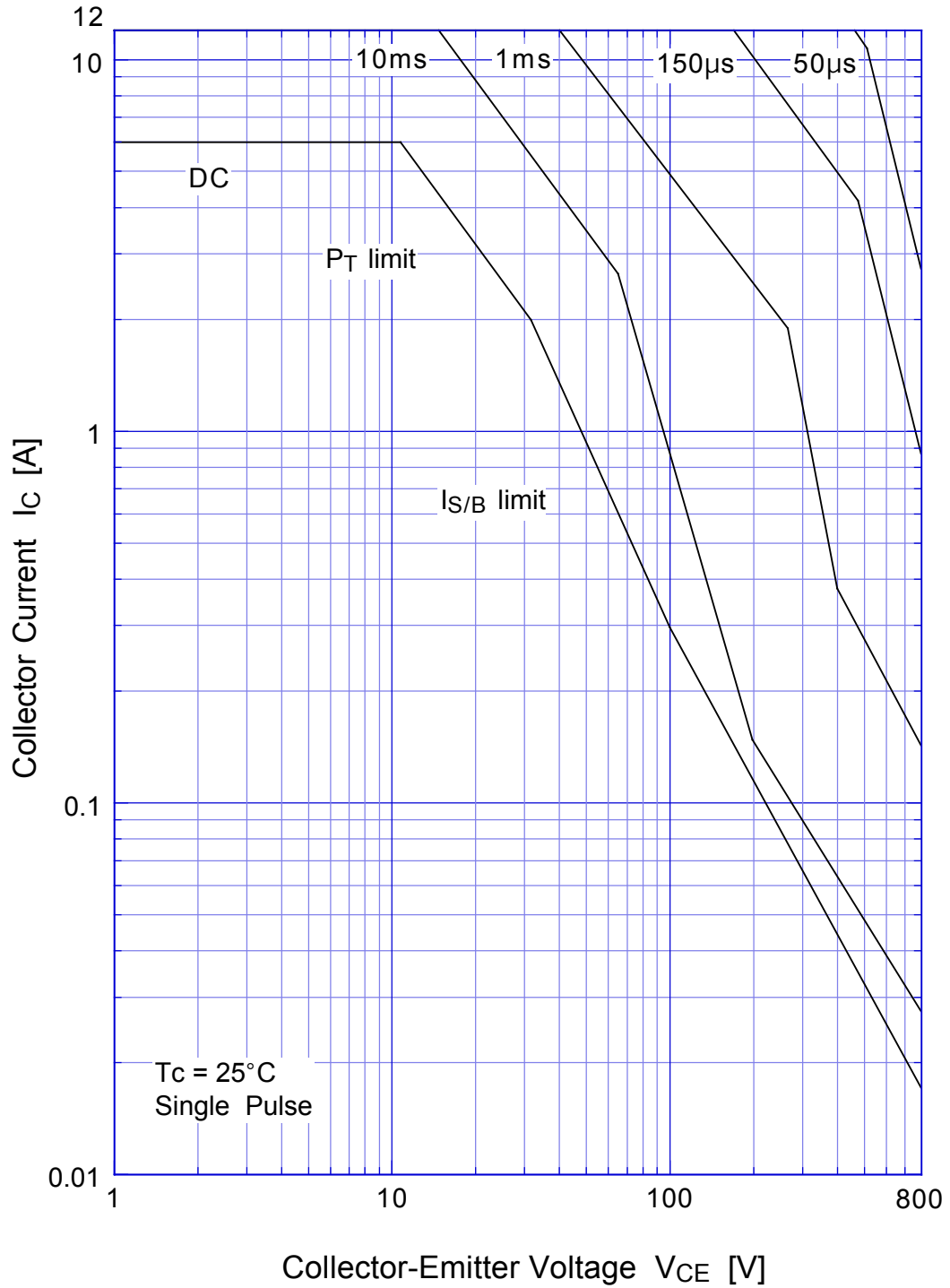

2SC4941 Collector Current Derating

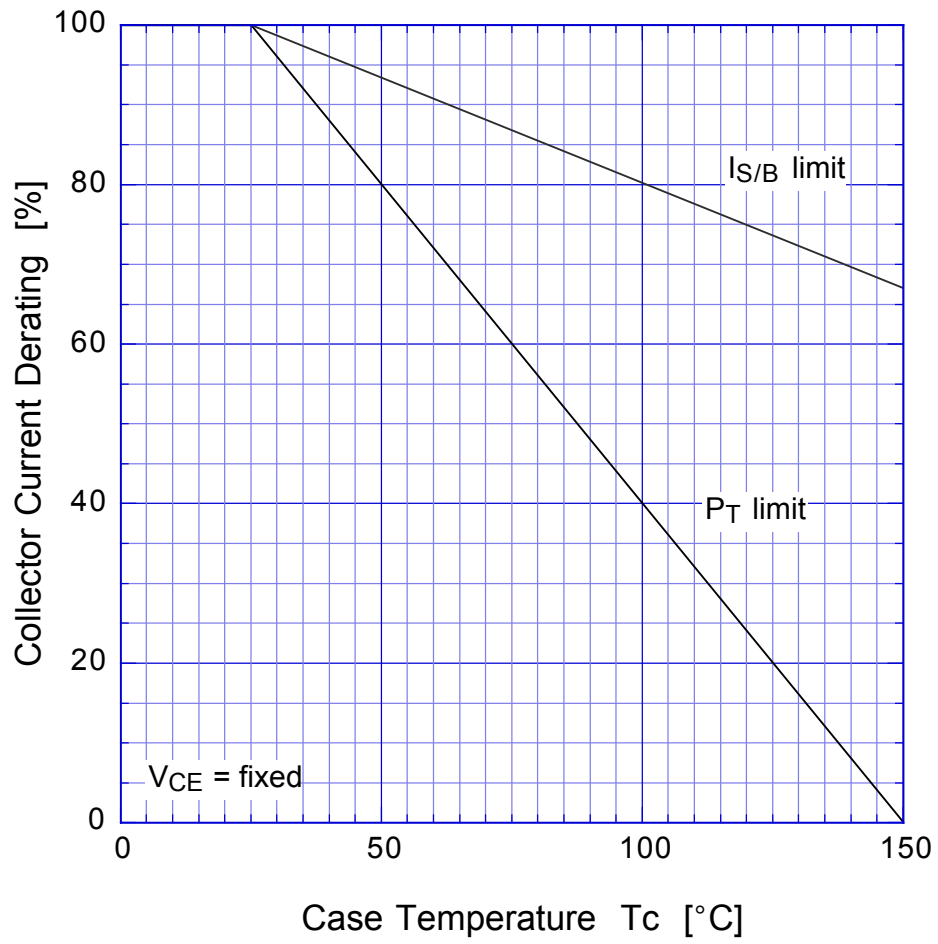

2SC4941

Reverse Bias SOA

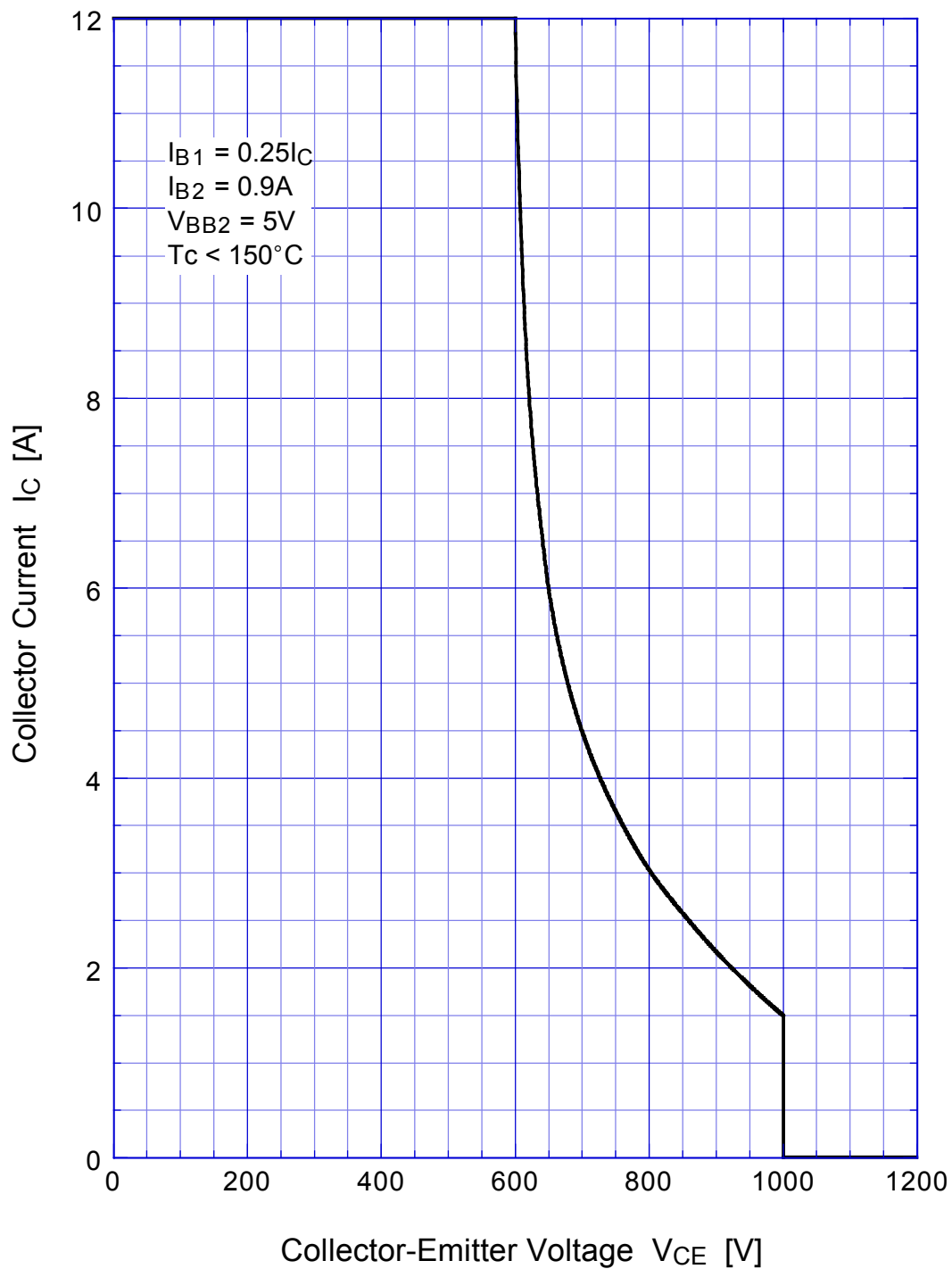

2SC4941 Transient Thermal Impedance

