

MC14175B

Quad Type D Flip-Flop

The MC14175B quad type D flip-flop is constructed with MOS P-channel and N-channel enhancement mode devices in a single monolithic structure. Each of the four flip-flops is positive-edge triggered by a common clock input (C). An active-low reset input (R) asynchronously resets all flip-flops. Each flip-flop has independent Data (D) inputs and complementary outputs (Q and \bar{Q}). These devices may be used as shift register elements or as type T flip-flops for counter and toggle applications.

- Complementary Outputs
- Static Operation
- All Inputs and Outputs Buffered
- Diode Protection on All Inputs
- Supply Voltage Range = 3.0 Vdc to 18 Vdc
- Output Compatible with Two Low-Power TTL Loads or One Low-Power Schottky TTL Load
- Functional Equivalent to TTL 74175

MAXIMUM RATINGS (Voltages Referenced to V_{SS}) (Note 2.)

Symbol	Parameter	Value	Unit
V_{DD}	DC Supply Voltage Range	-0.5 to +18.0	V
V_{in}, V_{out}	Input or Output Voltage Range (DC or Transient)	-0.5 to $V_{DD} + 0.5$	V
I_{in}, I_{out}	Input or Output Current (DC or Transient) per Pin	± 10	mA
P_D	Power Dissipation, per Package (Note 3.)	500	mW
T_A	Ambient Temperature Range	-55 to +125	$^{\circ}C$
T_{stg}	Storage Temperature Range	-65 to +150	$^{\circ}C$
T_L	Lead Temperature (8-Second Soldering)	260	$^{\circ}C$

- Maximum Ratings are those values beyond which damage to the device may occur.
- Temperature Derating:
Plastic "P and D/DW" Packages: -7.0 mW/ $^{\circ}C$ From 65 $^{\circ}C$ To 125 $^{\circ}C$

This device contains protection circuitry to guard against damage due to high static voltages or electric fields. However, precautions must be taken to avoid applications of any voltage higher than maximum rated voltages to this high-impedance circuit. For proper operation, V_{in} and V_{out} should be constrained to the range $V_{SS} \leq (V_{in} \text{ or } V_{out}) \leq V_{DD}$.

Unused inputs must always be tied to an appropriate logic voltage level (e.g., either V_{SS} or V_{DD}). Unused outputs must be left open.



ON Semiconductor

<http://onsemi.com>

MARKING DIAGRAMS

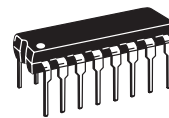

PDIP-16
P SUFFIX
CASE 648

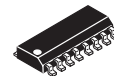
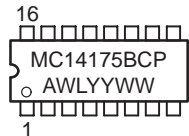

SOIC-16
D SUFFIX
CASE 751B

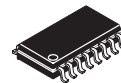
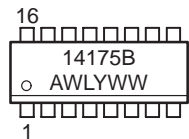

SOEIAJ-16
F SUFFIX
CASE 966

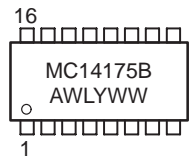

A = Assembly Location
WL or L = Wafer Lot
YY or Y = Year
WW or W = Work Week

ORDERING INFORMATION

Device	Package	Shipping
MC14175BCP	PDIP-16	2000/Box
MC14175BD	SOIC-16	48/Rail
MC14175BDR2	SOIC-16	2500/Tape & Reel
MC14175BF	SOEIAJ-16	See Note 1.
MC14175BFEL	SOEIAJ-16	See Note 1.

- For ordering information on the EIAJ version of the SOIC packages, please contact your local ON Semiconductor representative.

MC14175B

PIN ASSIGNMENT

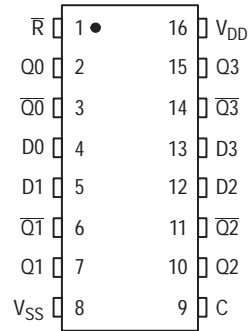

BLOCK DIAGRAM

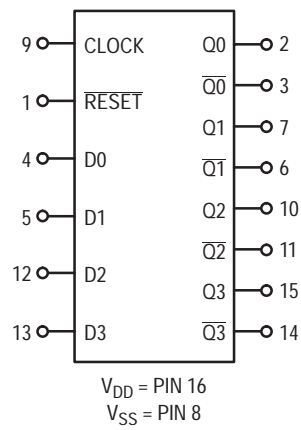

TRUTH TABLE

Inputs			Outputs	
Clock	Data	Reset	Q	Q
	0	1	0	1
	1	1	1	0
	X	1	Q	Q
X	X	0	0	1

No Change

X = Don't Care

MC14175B

ELECTRICAL CHARACTERISTICS (Voltages Referenced to V_{SS})

Characteristic	Symbol	V_{DD} Vdc	- 55°C		25°C			125°C		Unit	
			Min	Max	Min	Typ (4.)	Max	Min	Max		
Output Voltage $V_{in} = V_{DD}$ or 0	"0" Level V_{OL}	5.0	—	0.05	—	0	0.05	—	0.05	Vdc	
		10	—	0.05	—	0	0.05	—	0.05		
		15	—	0.05	—	0	0.05	—	0.05		
	"1" Level $V_{in} = 0$ or V_{DD}	V_{OH}	5.0	4.95	—	4.95	5.0	—	4.95		—
			10	9.95	—	9.95	10	—	9.95		—
			15	14.95	—	14.95	15	—	14.95		—
Input Voltage ($V_O = 4.5$ or 0.5 Vdc) ($V_O = 9.0$ or 1.0 Vdc) ($V_O = 13.5$ or 1.5 Vdc)	"0" Level V_{IL}	5.0	—	1.5	—	2.25	1.5	—	1.5	Vdc	
		10	—	3.0	—	4.50	3.0	—	3.0		
		15	—	4.0	—	6.75	4.0	—	4.0		
	"1" Level ($V_O = 0.5$ or 4.5 Vdc) ($V_O = 1.0$ or 9.0 Vdc) ($V_O = 1.5$ or 13.5 Vdc)	V_{IH}	5.0	3.5	—	3.5	2.75	—	3.5		—
			10	7.0	—	7.0	5.50	—	7.0		—
			15	11	—	11	8.25	—	11		—
Output Drive Current ($V_{OH} = 2.5$ Vdc) ($V_{OH} = 4.6$ Vdc) ($V_{OH} = 9.5$ Vdc) ($V_{OH} = 13.5$ Vdc)	Source I_{OH}	5.0	-3.0	—	-2.4	-4.2	—	-1.7	—	mAdc	
		5.0	-0.64	—	-0.51	-0.88	—	-0.36	—		
		10	-1.6	—	-1.3	-2.25	—	-0.9	—		
		15	-4.2	—	-3.4	-8.8	—	-2.4	—		
	Sink I_{OL}	5.0	0.64	—	0.51	0.88	—	0.36	—		mAdc
		10	1.6	—	1.3	2.25	—	0.9	—		
15	4.2	—	3.4	8.8	—	2.4	—	—			
Input Current	I_{in}	15	—	± 0.1	—	± 0.00001	± 0.1	—	± 1.0	μ Adc	
Input Capacitance ($V_{in} = 0$)	C_{in}	—	—	—	—	5.0	7.5	—	—	pF	
Quiescent Current (Per Package)	I_{DD}	5.0	—	5.0	—	0.005	5.0	—	150	μ Adc	
		10	—	10	—	0.010	10	—	300		
		15	—	20	—	0.015	20	—	600		
Total Supply Current (5.) (6.) (Dynamic plus Quiescent, Per Package) ($C_L = 50$ pF on all outputs, all buffers switching)	I_T	5.0	$I_T = (1.7 \mu\text{A/kHz}) f + I_{DD}$							μ Adc	
10	$I_T = (3.4 \mu\text{A/kHz}) f + I_{DD}$										
15	$I_T = (5.0 \mu\text{A/kHz}) f + I_{DD}$										

4. Data labelled "Typ" is not to be used for design purposes but is intended as an indication of the IC's potential performance.

5. The formulas given are for the typical characteristics only at 25°C.

6. To calculate total supply current at loads other than 50 pF:

$$I_T(C_L) = I_T(50 \text{ pF}) + (C_L - 50) Vfk$$

where: I_T is in μA (per package), C_L in pF, $V = (V_{DD} - V_{SS})$ in volts, f in kHz is input frequency, and $k = 0.004$.

MC14175B

SWITCHING CHARACTERISTICS (7.) ($C_L = 50 \text{ pF}$, $T_A = 25^\circ\text{C}$)

Characteristic	Symbol	V_{DD} Vdc	All Types			Unit
			Min	Typ (8.)	Max	
Output Rise and Fall Time t_{TLH} , $t_{THL} = (1.35 \text{ ns/pF}) C_L + 32 \text{ ns}$ t_{TLH} , $t_{THL} = (0.6 \text{ ns/pF}) C_L + 20 \text{ ns}$ t_{TLH} , $t_{THL} = (0.4 \text{ ns/pF}) C_L + 20 \text{ ns}$	t_{TLH} , t_{THL}	5.0 10 15	— — —	100 50 40	200 100 80	ns
Propagation Delay Time — Clock to Q, Q t_{PLH} , $t_{PHL} = (0.9 \text{ ns/pF}) C_L + 175 \text{ ns}$ t_{PLH} , $t_{PHL} = (0.36 \text{ ns/pF}) C_L + 72 \text{ ns}$ t_{PLH} , $t_{PHL} = (0.26 \text{ ns/pF}) C_L + 57 \text{ ns}$	t_{PLH} , t_{PHL}	5.0 10 15	— — —	220 90 70	400 160 120	ns
Propagation Delay Time — Reset to Q, Q $t_{PHL} = (0.9 \text{ ns/pF}) C_L + 280 \text{ ns}$ $t_{PHL} = (0.36 \text{ ns/pF}) C_L + 112 \text{ ns}$ $t_{PHL} = (0.26 \text{ ns/pF}) C_L + 87 \text{ ns}$	t_{PHL} , t_{PLH}	5.0 10 15	— — —	325 130 100	500 200 150	ns
Clock Pulse Width	t_{WH}	5.0 10 15	250 100 75	110 45 35	— — —	ns
Reset Pulse Width	t_{WL}	5.0 10 15	200 80 60	100 40 30	— — —	ns
Clock Pulse Frequency	f_{cl}	5.0 10 15	— — —	4.5 11 14	2.0 5.0 6.5	mHz
Clock Pulse Rise and Fall Time	t_{TLH} , t_{THL}	5.0 10 15	— — —	— — —	15 5.0 4.0	μs
Data Setup Time	t_{su}	5.0 10 15	120 50 40	60 25 20	— — —	ns
Data Hold Time	t_h	5.0 10 15	80 40 30	40 20 15	— — —	ns
Reset Removal Time	t_{rem}	5.0 10 15	250 100 80	125 50 40	— — —	ns

7. The formulas given are for the typical characteristics only at 25°C .

8. Data labelled "Typ" is not to be used for design purposes but is intended as an indication of the IC's potential performance.

MC14175B

TIMING DIAGRAM

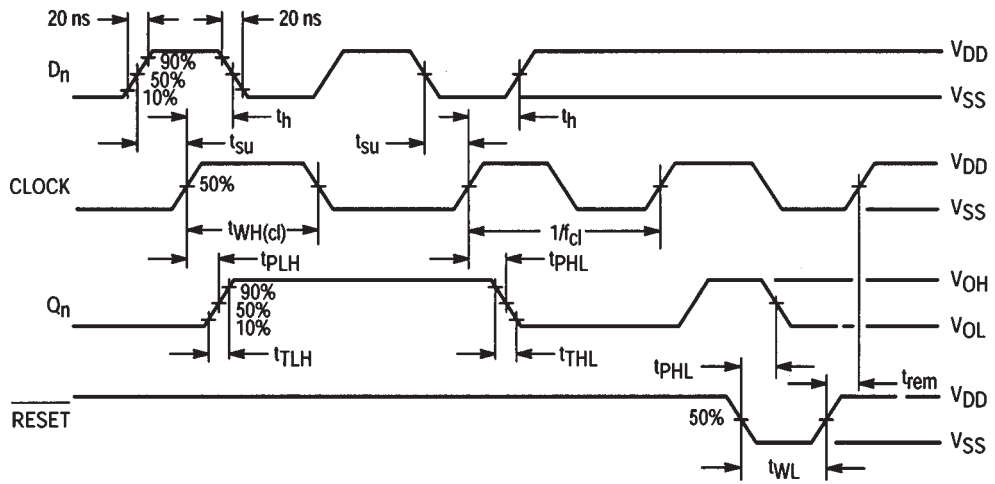

FUNCTIONAL BLOCK DIAGRAM

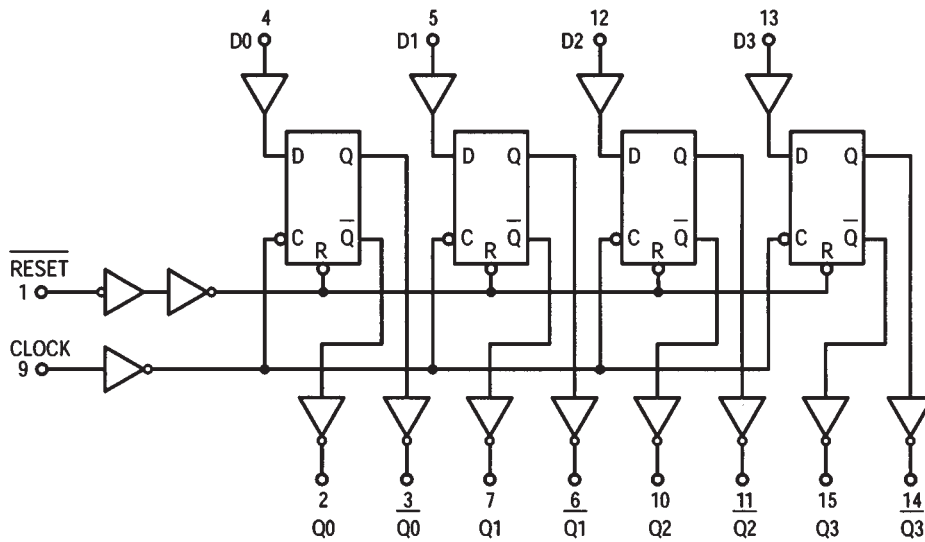

MC14175B

PACKAGE DIMENSIONS

PDIP-16 P SUFFIX PLASTIC DIP PACKAGE CASE 648-08 ISSUE R

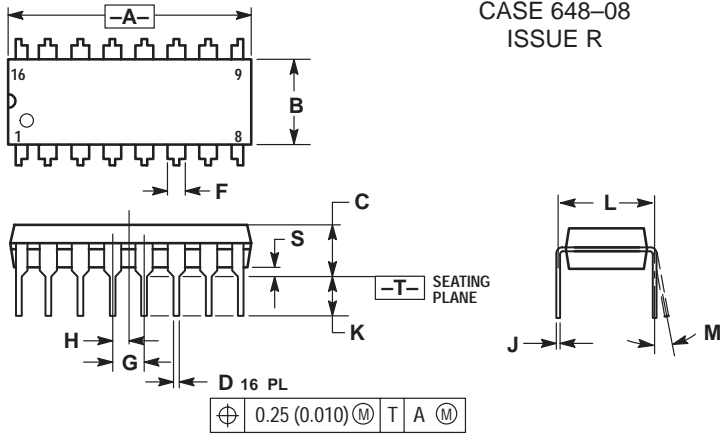

- NOTES:
1. DIMENSIONING AND TOLERANCING PER ANSI Y14.5M, 1982.
 2. CONTROLLING DIMENSION: INCH.
 3. DIMENSION L TO CENTER OF LEADS WHEN FORMED PARALLEL.
 4. DIMENSION B DOES NOT INCLUDE MOLD FLASH.
 5. ROUNDED CORNERS OPTIONAL.

DIM	INCHES		MILLIMETERS	
	MIN	MAX	MIN	MAX
A	0.740	0.770	18.80	19.55
B	0.250	0.270	6.35	6.85
C	0.145	0.175	3.69	4.44
D	0.015	0.021	0.39	0.53
F	0.040	0.70	1.02	1.77
G	0.100 BSC		2.54 BSC	
H	0.050 BSC		1.27 BSC	
J	0.008	0.015	0.21	0.38
K	0.110	0.130	2.80	3.30
L	0.295	0.305	7.50	7.74
M	0°	10°	0°	10°
S	0.020	0.040	0.51	1.01

SOIC-16 D SUFFIX PLASTIC SOIC PACKAGE CASE 751B-05 ISSUE J

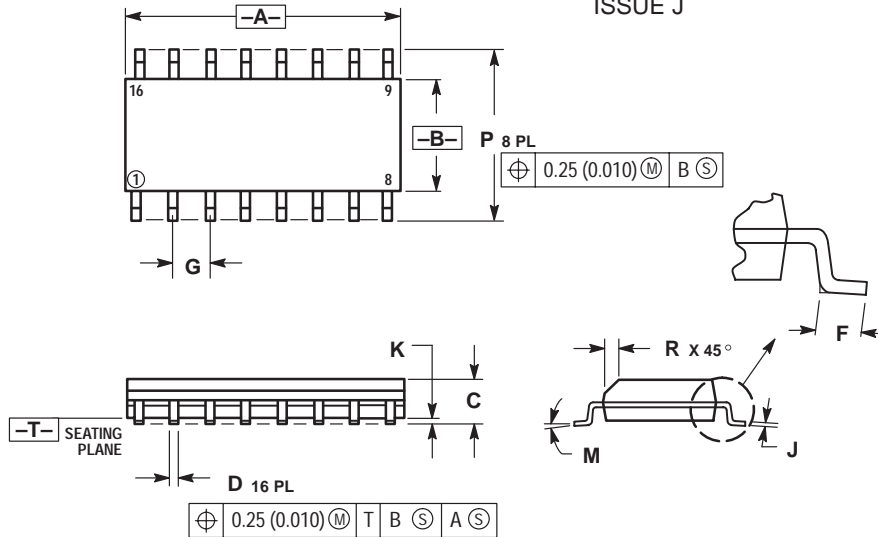

- NOTES:
1. DIMENSIONING AND TOLERANCING PER ANSI Y14.5M, 1982.
 2. CONTROLLING DIMENSION: MILLIMETER.
 3. DIMENSIONS A AND B DO NOT INCLUDE MOLD PROTRUSION.
 4. MAXIMUM MOLD PROTRUSION 0.15 (0.006) PER SIDE.
 5. DIMENSION D DOES NOT INCLUDE DAMBAR PROTRUSION. ALLOWABLE DAMBAR PROTRUSION SHALL BE 0.127 (0.005) TOTAL IN EXCESS OF THE D DIMENSION AT MAXIMUM MATERIAL CONDITION.

DIM	MILLIMETERS		INCHES	
	MIN	MAX	MIN	MAX
A	9.80	10.00	0.386	0.393
B	3.80	4.00	0.150	0.157
C	1.35	1.75	0.054	0.068
D	0.35	0.49	0.014	0.019
F	0.40	1.25	0.016	0.049
G	1.27 BSC		0.050 BSC	
J	0.19	0.25	0.008	0.009
K	0.10	0.25	0.004	0.009
M	0°	7°	0°	7°
P	5.80	6.20	0.229	0.244
R	0.25	0.50	0.010	0.019

MC14175B

PACKAGE DIMENSIONS

SOEIAJ-16 F SUFFIX PLASTIC EIAJ SOIC PACKAGE CASE 966-01 ISSUE O

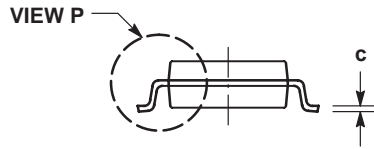
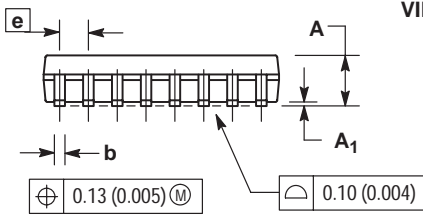
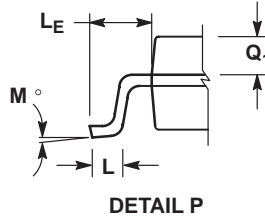
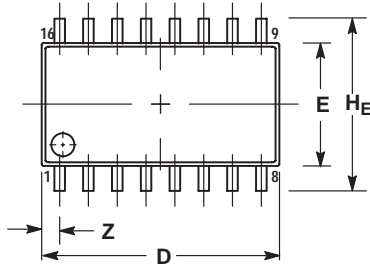

NOTES:

1. DIMENSIONING AND TOLERANCING PER ANSI Y14.5M, 1982.
2. CONTROLLING DIMENSION: MILLIMETER.
3. DIMENSIONS D AND E DO NOT INCLUDE MOLD FLASH OR PROTRUSIONS AND ARE MEASURED AT THE PARTING LINE. MOLD FLASH OR PROTRUSIONS SHALL NOT EXCEED 0.15 (0.006) PER SIDE.
4. TERMINAL NUMBERS ARE SHOWN FOR REFERENCE ONLY.
5. THE LEAD WIDTH DIMENSION (b) DOES NOT INCLUDE DAMBAR PROTRUSION. ALLOWABLE DAMBAR PROTRUSION SHALL BE 0.08 (0.003) TOTAL IN EXCESS OF THE LEAD WIDTH DIMENSION AT MAXIMUM MATERIAL CONDITION. DAMBAR CANNOT BE LOCATED ON THE LOWER RADIUS OR THE FOOT. MINIMUM SPACE BETWEEN PROTRUSIONS AND ADJACENT LEAD TO BE 0.46 (0.018).

DIM	MILLIMETERS		INCHES	
	MIN	MAX	MIN	MAX
A	---	2.05	---	0.081
A ₁	0.05	0.20	0.002	0.008
b	0.35	0.50	0.014	0.020
c	0.18	0.27	0.007	0.011
D	9.90	10.50	0.390	0.413
E	5.10	5.45	0.201	0.215
e	1.27 BSC		0.050 BSC	
H _E	7.40	8.20	0.291	0.323
L	0.50	0.85	0.020	0.033
L _F	1.10	1.50	0.043	0.059
M	0°	10°	0°	10°
Q ₁	0.70	0.90	0.028	0.035
Z	---	0.78	---	0.031

ON Semiconductor and  are trademarks of Semiconductor Components Industries, LLC (SCILLC). SCILLC reserves the right to make changes without further notice to any products herein. SCILLC makes no warranty, representation or guarantee regarding the suitability of its products for any particular purpose, nor does SCILLC assume any liability arising out of the application or use of any product or circuit, and specifically disclaims any and all liability, including without limitation special, consequential or incidental damages. "Typical" parameters which may be provided in SCILLC data sheets and/or specifications can and do vary in different applications and actual performance may vary over time. All operating parameters, including "Typicals" must be validated for each customer application by customer's technical experts. SCILLC does not convey any license under its patent rights nor the rights of others. SCILLC products are not designed, intended, or authorized for use as components in systems intended for surgical implant into the body, or other applications intended to support or sustain life, or for any other application in which the failure of the SCILLC product could create a situation where personal injury or death may occur. Should Buyer purchase or use SCILLC products for any such unintended or unauthorized application, Buyer shall indemnify and hold SCILLC and its officers, employees, subsidiaries, affiliates, and distributors harmless against all claims, costs, damages, and expenses, and reasonable attorney fees arising out of, directly or indirectly, any claim of personal injury or death associated with such unintended or unauthorized use, even if such claim alleges that SCILLC was negligent regarding the design or manufacture of the part. SCILLC is an Equal Opportunity/Affirmative Action Employer.

PUBLICATION ORDERING INFORMATION

NORTH AMERICA Literature Fulfillment:

Literature Distribution Center for ON Semiconductor
P.O. Box 5163, Denver, Colorado 80217 USA
Phone: 303-675-2175 or 800-344-3860 Toll Free USA/Canada
Fax: 303-675-2176 or 800-344-3867 Toll Free USA/Canada
Email: ONlit@hibbertco.com
Fax Response Line: 303-675-2167 or 800-344-3810 Toll Free USA/Canada

N. American Technical Support: 800-282-9855 Toll Free USA/Canada

EUROPE: LDC for ON Semiconductor – European Support

German Phone: (+1) 303-308-7140 (M-F 1:00pm to 5:00pm Munich Time)
Email: ONlit-german@hibbertco.com
French Phone: (+1) 303-308-7141 (M-F 1:00pm to 5:00pm Toulouse Time)
Email: ONlit-french@hibbertco.com
English Phone: (+1) 303-308-7142 (M-F 12:00pm to 5:00pm UK Time)
Email: ONlit@hibbertco.com

EUROPEAN TOLL-FREE ACCESS*: 00-800-4422-3781

*Available from Germany, France, Italy, England, Ireland

CENTRAL/SOUTH AMERICA:

Spanish Phone: 303-308-7143 (Mon-Fri 8:00am to 5:00pm MST)
Email: ONlit-spanish@hibbertco.com

ASIA/PACIFIC: LDC for ON Semiconductor – Asia Support

Phone: 303-675-2121 (Tue-Fri 9:00am to 1:00pm, Hong Kong Time)
Toll Free from Hong Kong & Singapore:
001-800-4422-3781
Email: ONlit-asia@hibbertco.com

JAPAN: ON Semiconductor, Japan Customer Focus Center
4-32-1 Nishi-Gotanda, Shinagawa-ku, Tokyo, Japan 141-8549

Phone: 81-3-5740-2745
Email: r14525@onsemi.com

ON Semiconductor Website: <http://onsemi.com>

For additional information, please contact your local Sales Representative.