

2SC4585

(TP10W80HFX)

10A NPN

OUTLINE DIMENSIONS

Case : ITO-3P

Unit : mm

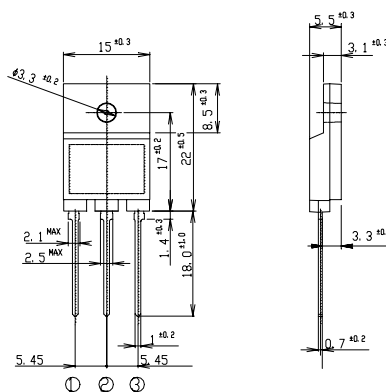

⊙: B
 ⊘: C
 ⊚: E

RATINGS

● Absolute Maximum Ratings

Item	Symbol	Conditions	Ratings	Unit
Storage Temperature	T_{stg}		-55 ~ 150	°C
Junction Temperature	T_j		150	°C
Collector to Base Voltage	V_{CB0}		1200	V
Collector to Emitter Voltage	V_{CEO}		800	V
Emitter to Base Voltage	V_{EBO}		7	V
Collector Current DC	I_C		10	A
Collector Current Peak	I_{CP}		20	A
Base Current DC	I_B		4	A
Base Current Peak	I_{BP}		8	A
Total Transistor Dissipation	P_T	$T_c = 25^\circ\text{C}$	85	W
Dielectric Strength	V_{dis}	Terminals to case, AC 1 minute	2	kV
Mounting Torque	TOR	(Recommended torque : 0.5N·m)	0.8	N·m

● Electrical Characteristics ($T_c=25^\circ\text{C}$)

Item	Symbol	Conditions	Ratings	Unit
Collector to Emitter Sustaining Voltage	$V_{CEO(sus)}$	$I_C = 0.2\text{A}$	Min 800	V
Collector Cutoff Current	I_{CBO}	At rated Voltage	Max 0.1	mA
	I_{CEO}		Max 0.1	
Emitter Cutoff Current	I_{EBO}	At rated Voltage	Max 0.1	mA
DC Current Gain	h_{FE}	$V_{CE} = 5\text{V}, I_C = 5\text{A}$	Min 8	
	h_{FEL}	$V_{CE} = 5\text{V}, I_C = 1\text{mA}$	Min 7	
Collector to Emitter Saturation Voltage	$V_{CE(sat)}$	$I_C = 5\text{A}$	Max 1.0	V
Base to Emitter Saturation Voltage	$V_{BE(sat)}$	$I_B = 1\text{A}$	Max 1.5	V
Thermal Resistance	θ_{jc}	Junction to case	Max 1.47	°C/W
Transition Frequency	f_T	$V_{CE} = 10\text{V}, I_C = 1\text{A}$	TYP 8	MHz
Turn on Time	t_{on}	$I_C = 5\text{A}$	Max 0.5	μs
Storage Time	t_s	$I_{B1} = 1\text{A}, I_{B2} = 2\text{A}$	Max 3.5	
Fall Time	t_f	$R_L = 50\ \Omega, V_{BB2} = 4\text{V}$	Max 0.3	

2SC4585

$h_{FE} - I_C$

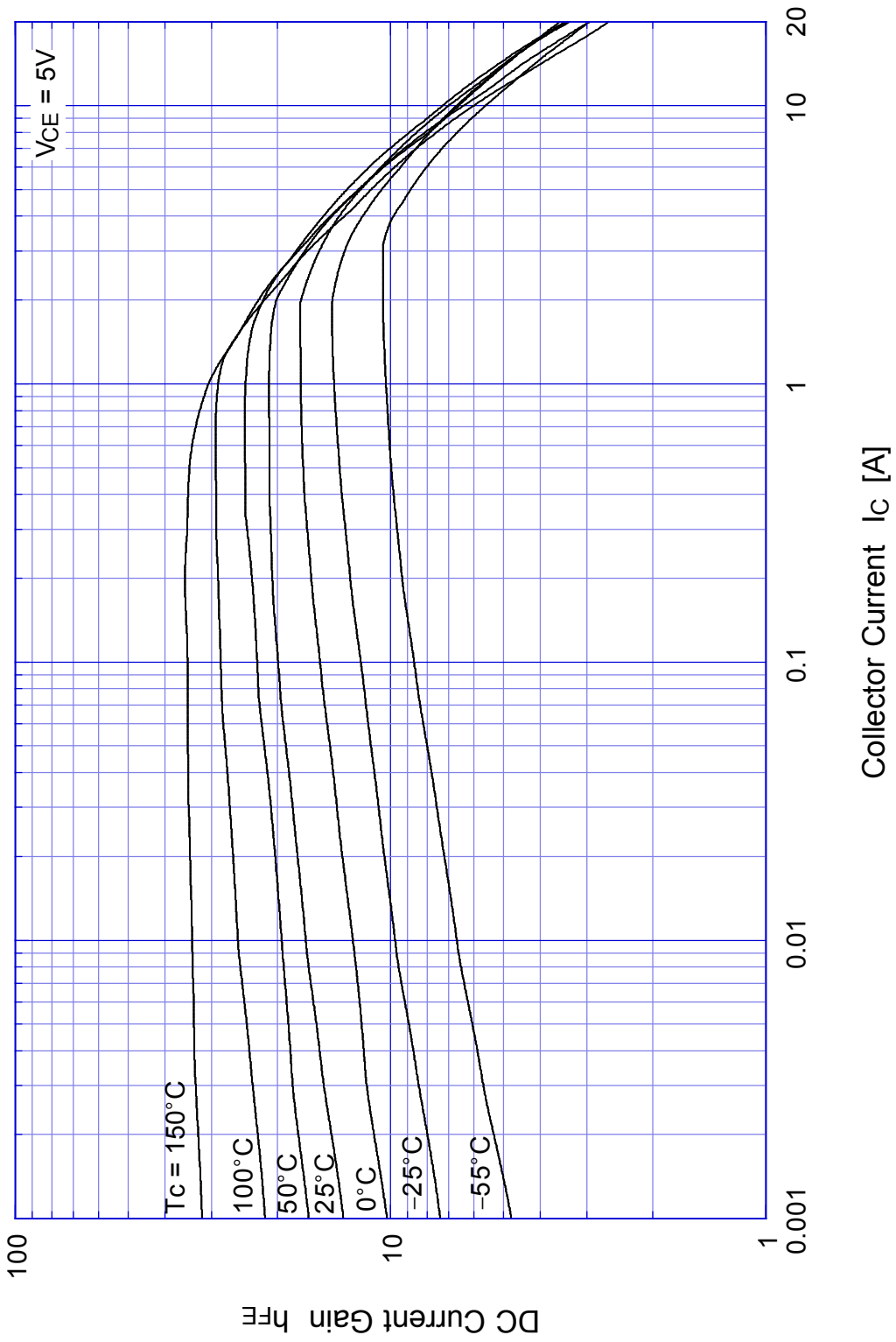

2SC4585 Saturation Voltage

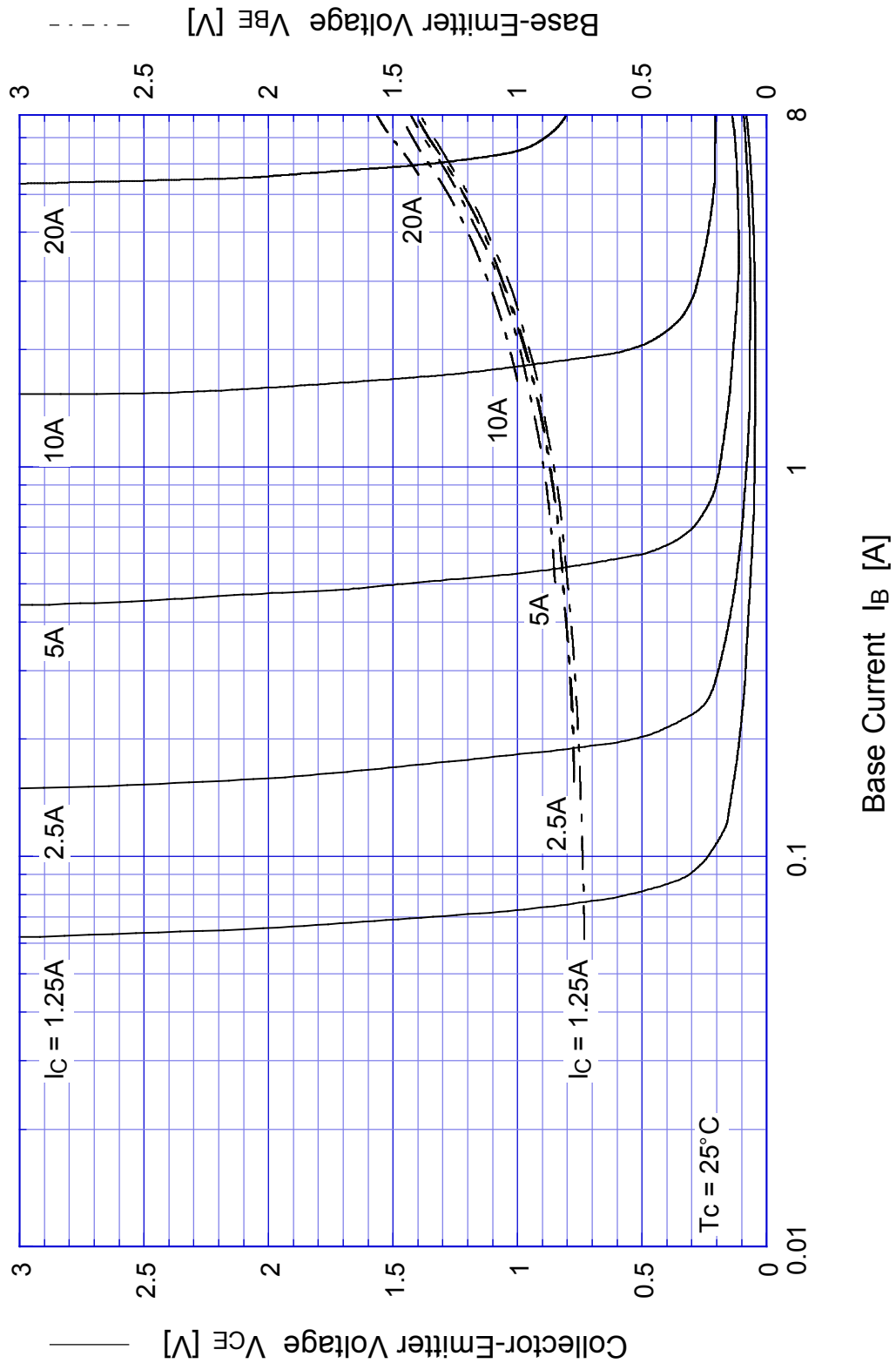

2SC4585 Switching Time - I_C

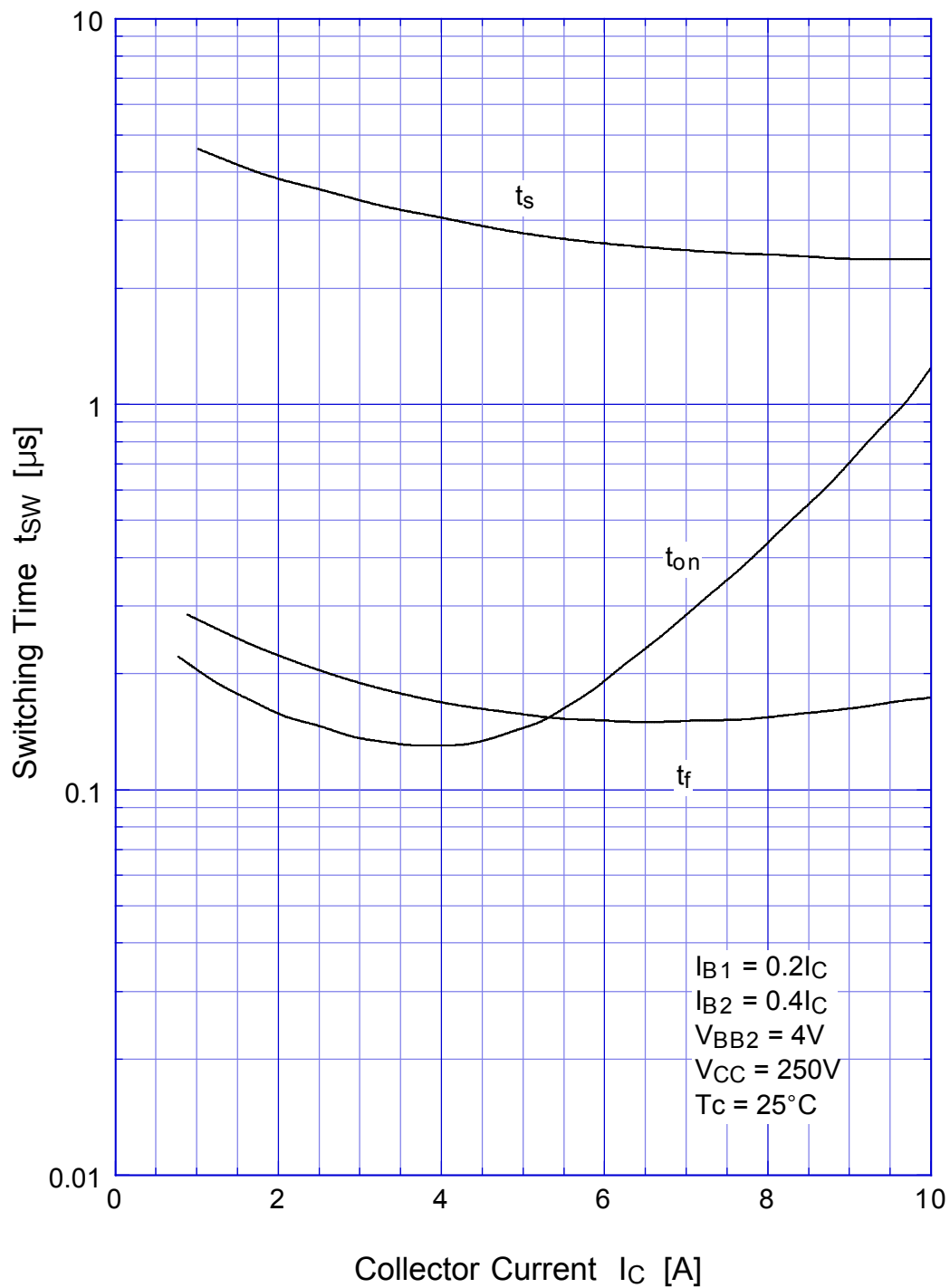

2SC4585 Switching Time - V_{CC}

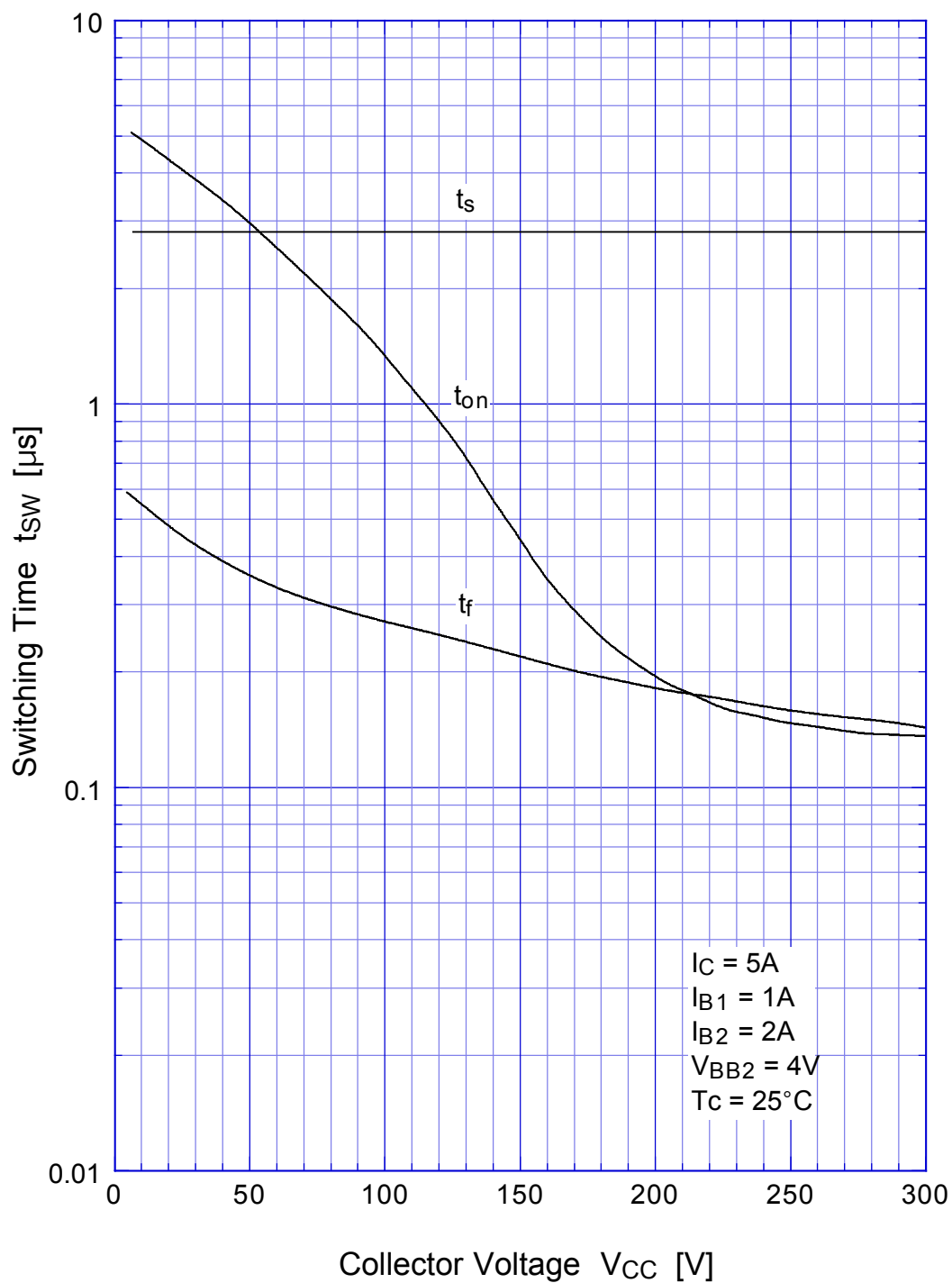

2SC4585 Switching Time - Tc

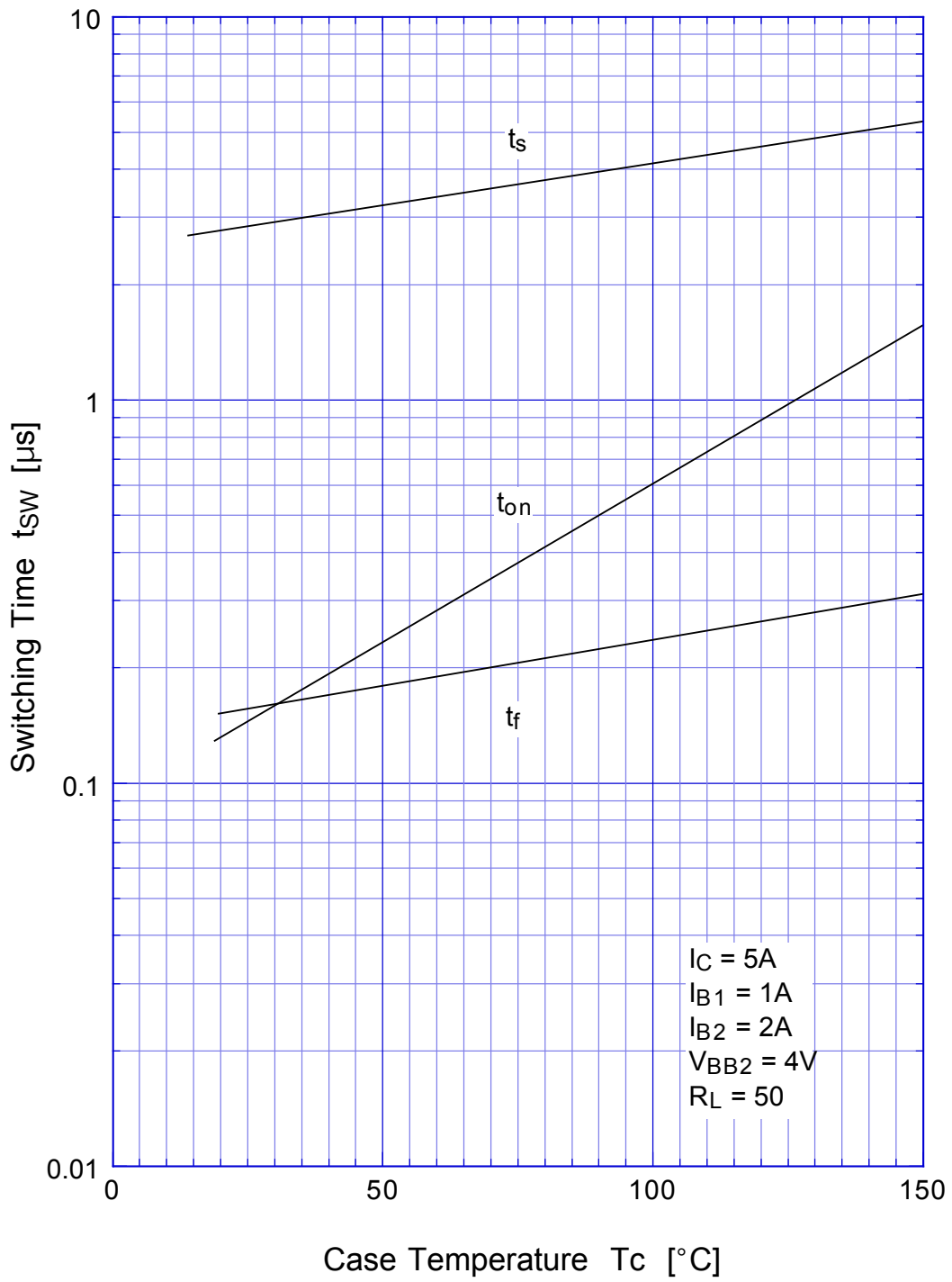

2SC4585 Transient Thermal Impedance

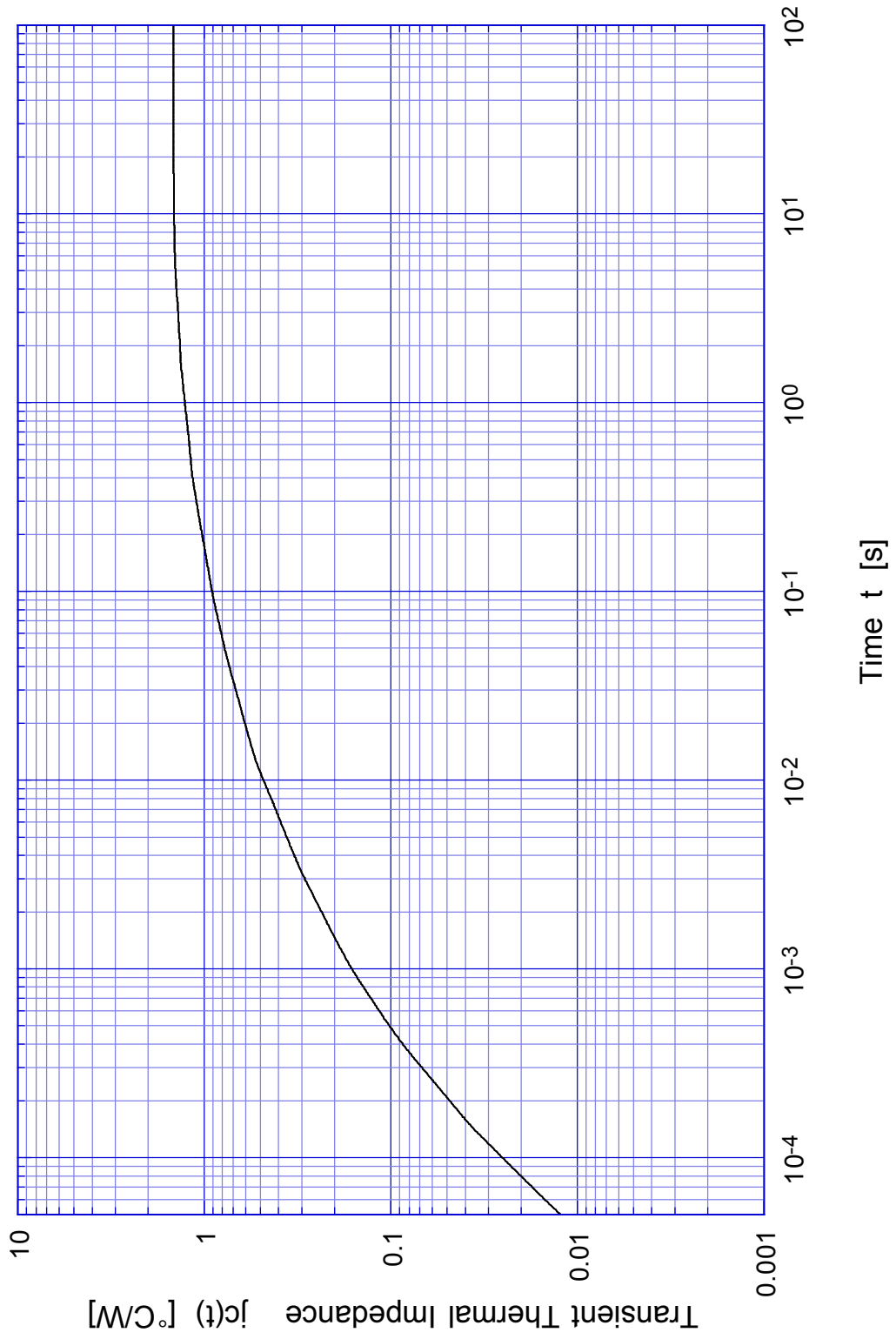

2SC4585 Forward Bias SOA

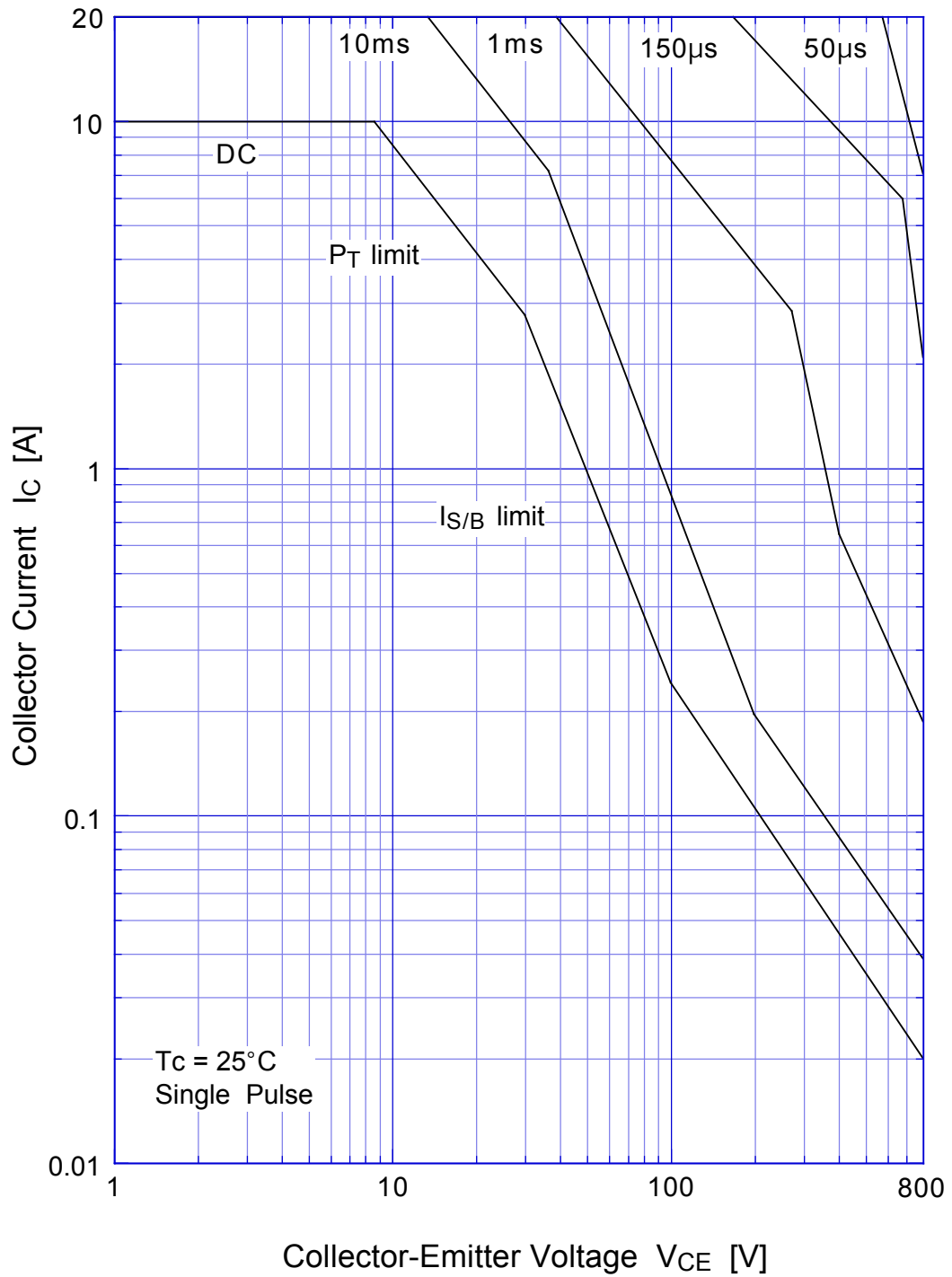

2SC4585 Collector Current Derating

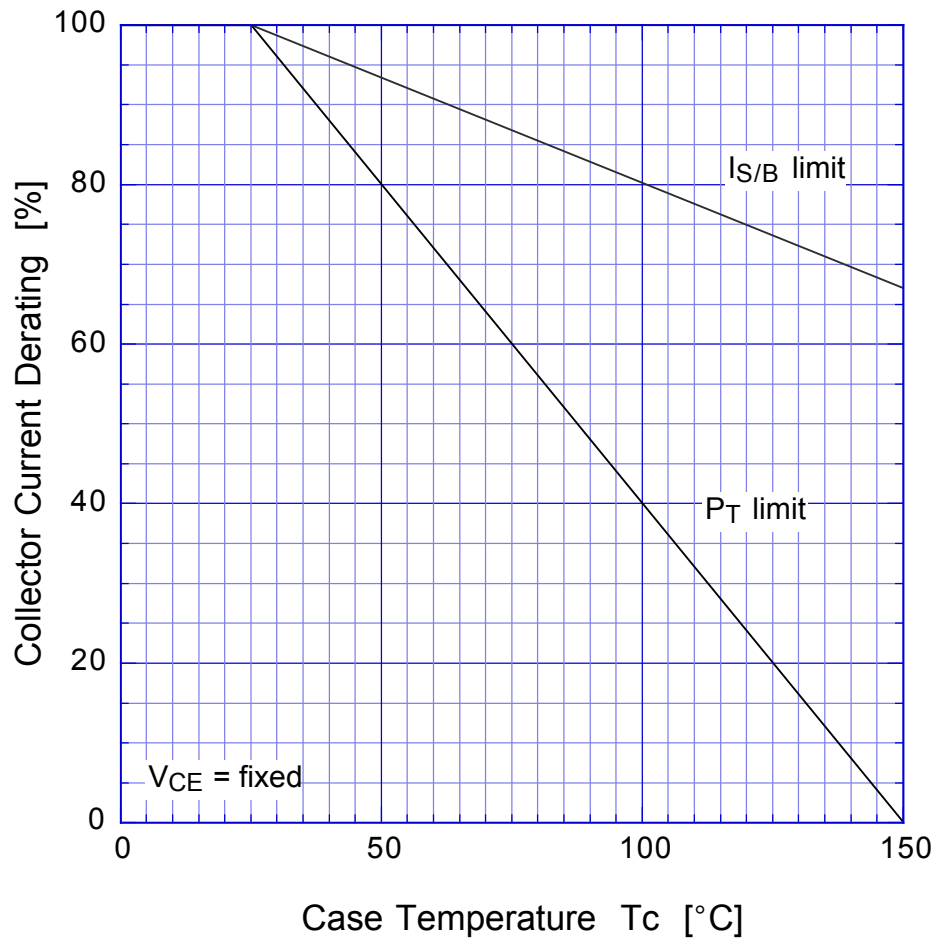

2SC4585

Reverse Bias SOA

