

2SC4582 (TP15W45FX)

15A NPN

OUTLINE DIMENSIONS

Case : ITO-3P

Unit : mm

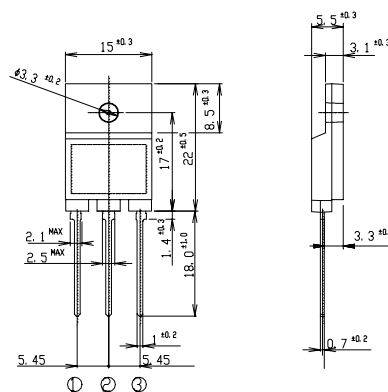

①: B
②: C
③: E

RATINGS

● Absolute Maximum Ratings

Item	Symbol	Conditions	Ratings	Unit
Storage Temperature	T _{stg}		-55 ~ 150	°C
Junction Temperature	T _j		150	°C
Collector to Base Voltage	V _{CBO}		600	V
Collector to Emitter Voltage	V _{CEO}		450	V
	V _{CEX}	V _{EB} = 5V	600	V
Emitter to Base Voltage	V _{EBO}		7	V
Collector Current DC	I _C		15	A
Collector Current Peak	I _{CP}		30	A
Base Current DC	I _B		6	A
Base Current Peak	I _{BP}		12	A
Total Transistor Dissipation	P _T	T _c = 25°C	75	W
Dielectric Strength	V _{dis}	Terminals to case, AC 1 minute	2	kV
Mounting Torque	TOR		0.8	N·m

● Electrical Characteristics (T_c=25°C)

Item	Symbol	Conditions	Ratings	Unit
Collector to Emitter Sustaining Voltage	V _{CEO(sus)}	I _C = 0.2A	Min 450	V
Collector Cutoff Current	I _{CBO}	At rated Voltage	Max 0.1	mA
	I _{CEO}		Max 0.1	
Emitter Cutoff Current	I _{EBO}	At rated Voltage	Max 0.1	mA
DC Current Gain	h _{FE}	V _{CE} = 5V, I _C = 7.5A	Min 10	
	h _{FEL}	V _{CE} = 5V, I _C = 1mA	Min 5	
Collector to Emitter Saturation Voltage	V _{CE(sat)}	I _C = 7.5A	Max 1.0	V
Base to Emitter Saturation Voltage	V _{BE(sat)}	I _B = 1.5A	Max 1.5	V
Thermal Resistance	θ _{jc}	Junction to case	Max 1.67	°C/W
Transition Frequency	f _T	V _{CE} = 10V, I _C = 1.5A	STD 20	MHz
Turn on Time	ton	I _C = 7.5A	Max 0.5	μs
Storage Time	ts	I _{B1} = 1.5A, I _{B2} = 3A	Max 2.0	
Fall Time	tf	R _L = 20 Ω, V _{BB2} = 4V	Max 0.2	

2SC4582

$h_{FE} - I_C$

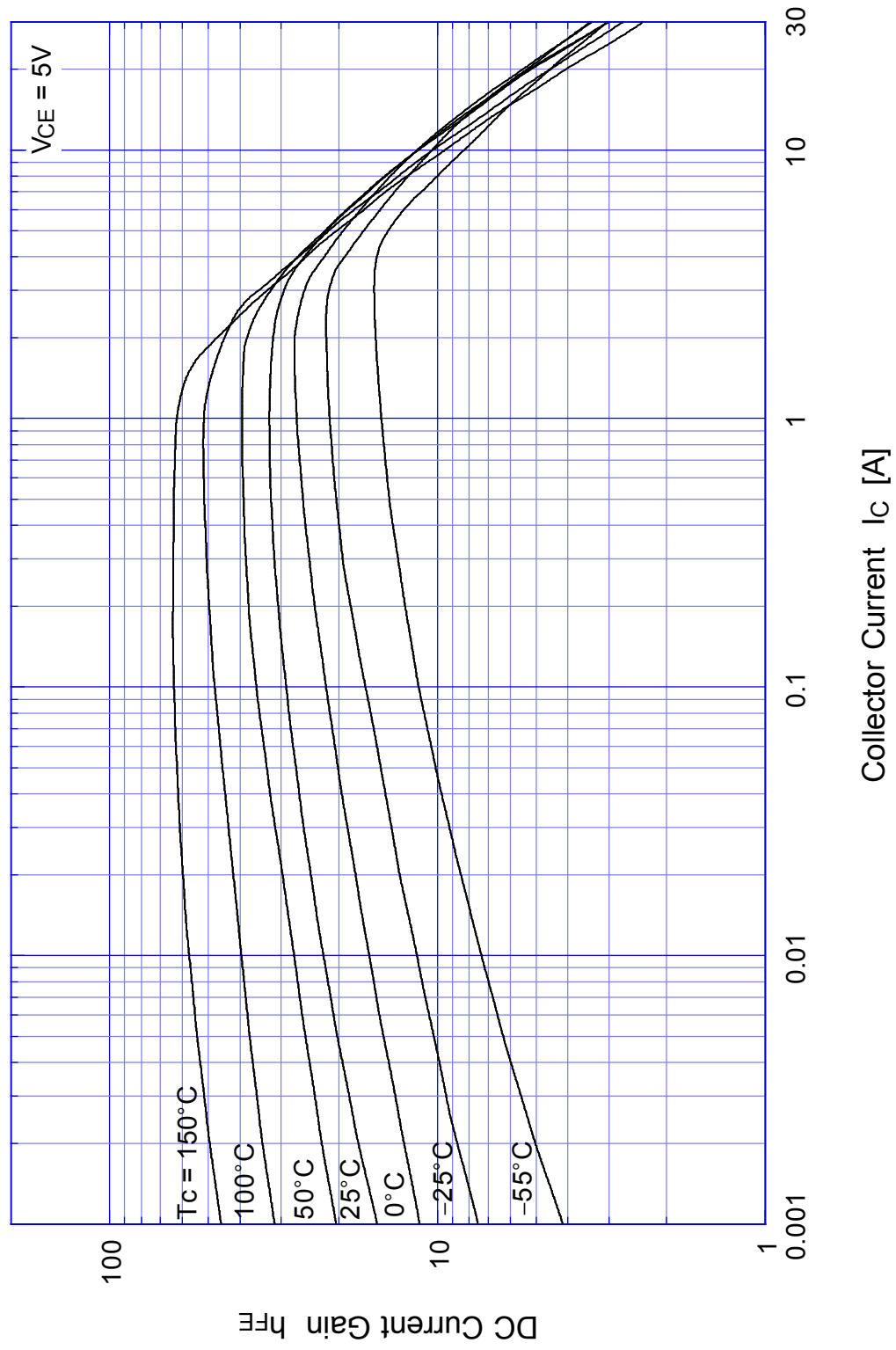

2SC4582 Saturation Voltage

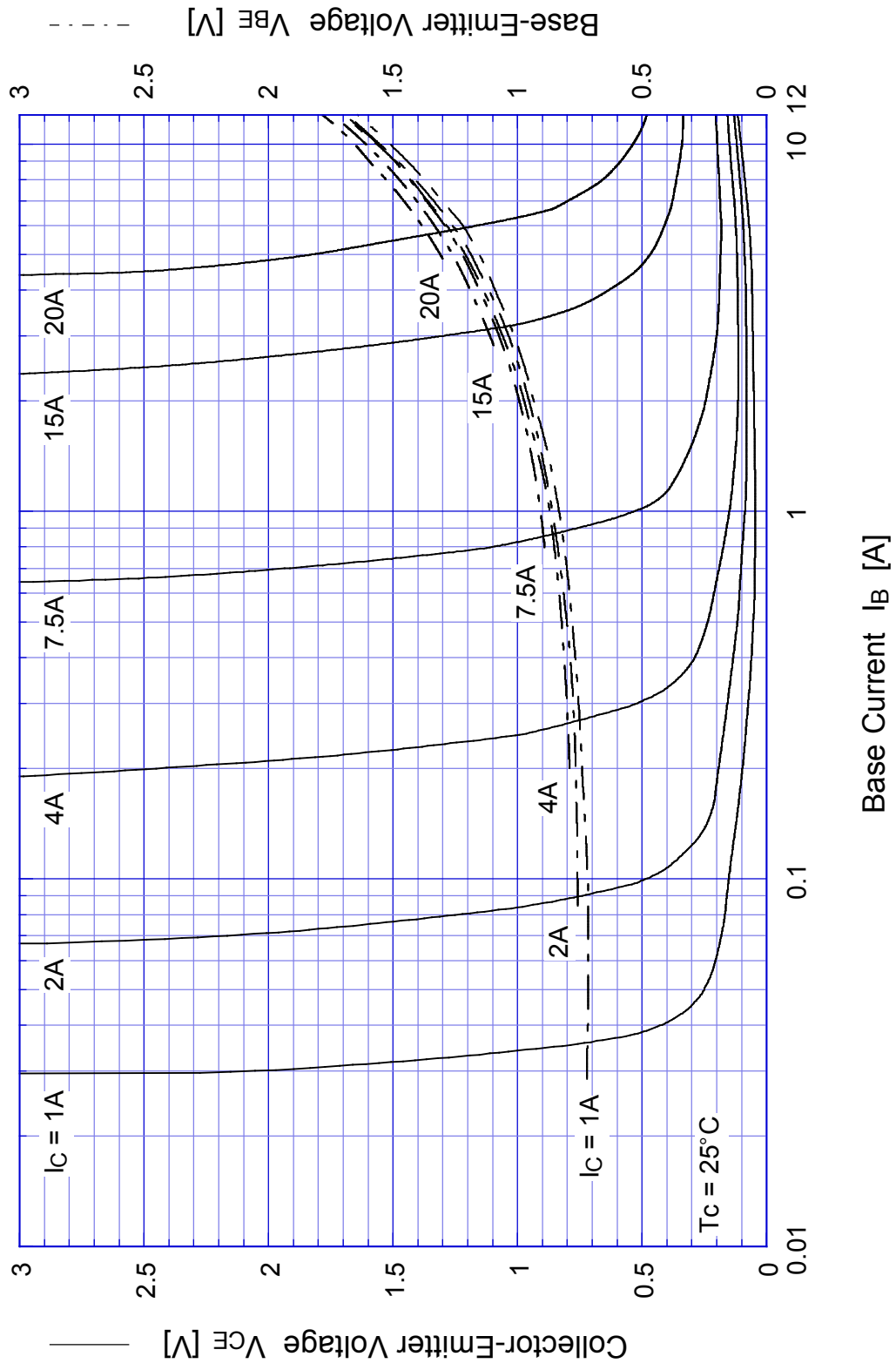

2SC4582 Switching Time - I_C

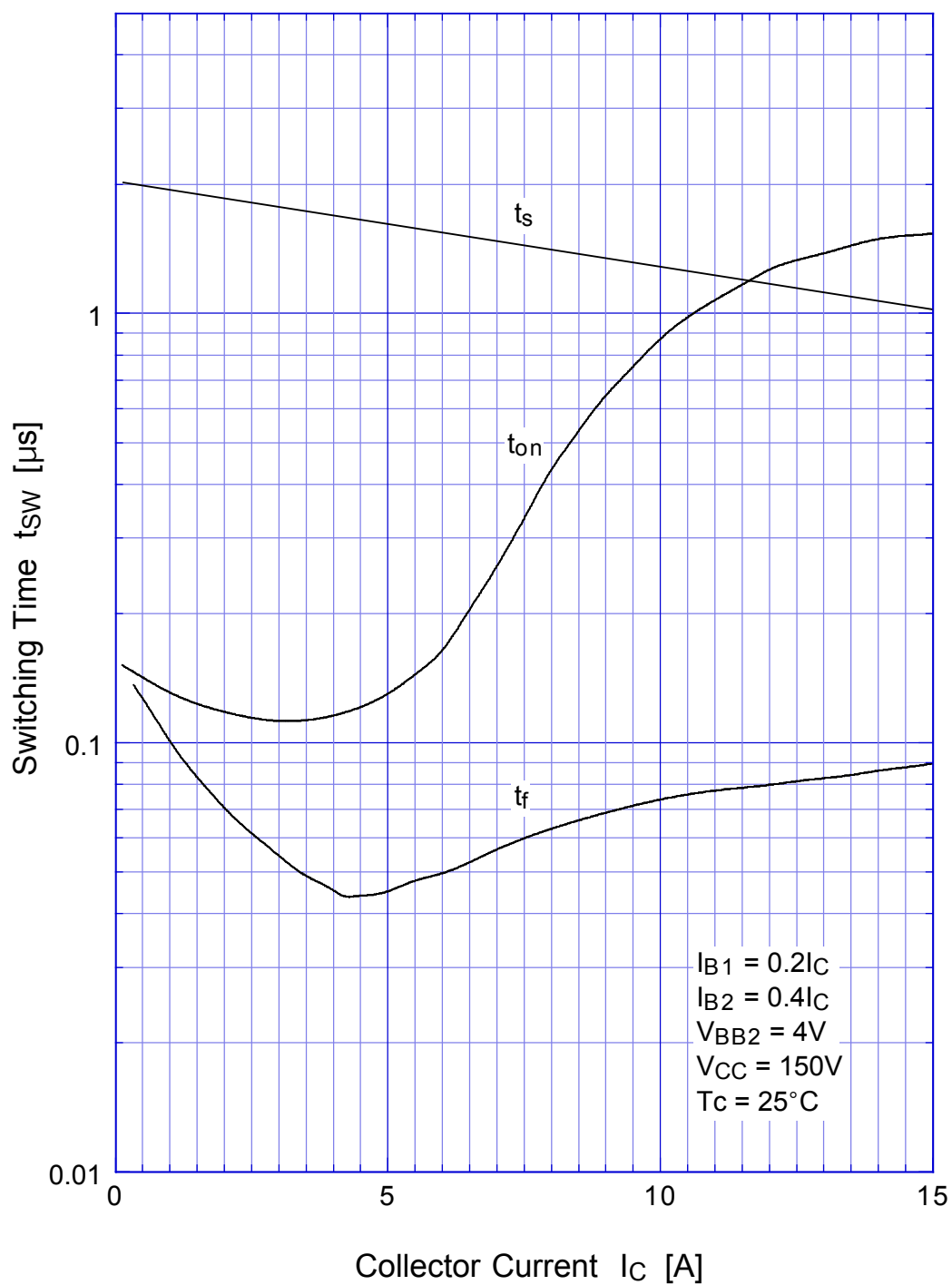

2SC4582 Switching Time - V_{CC}

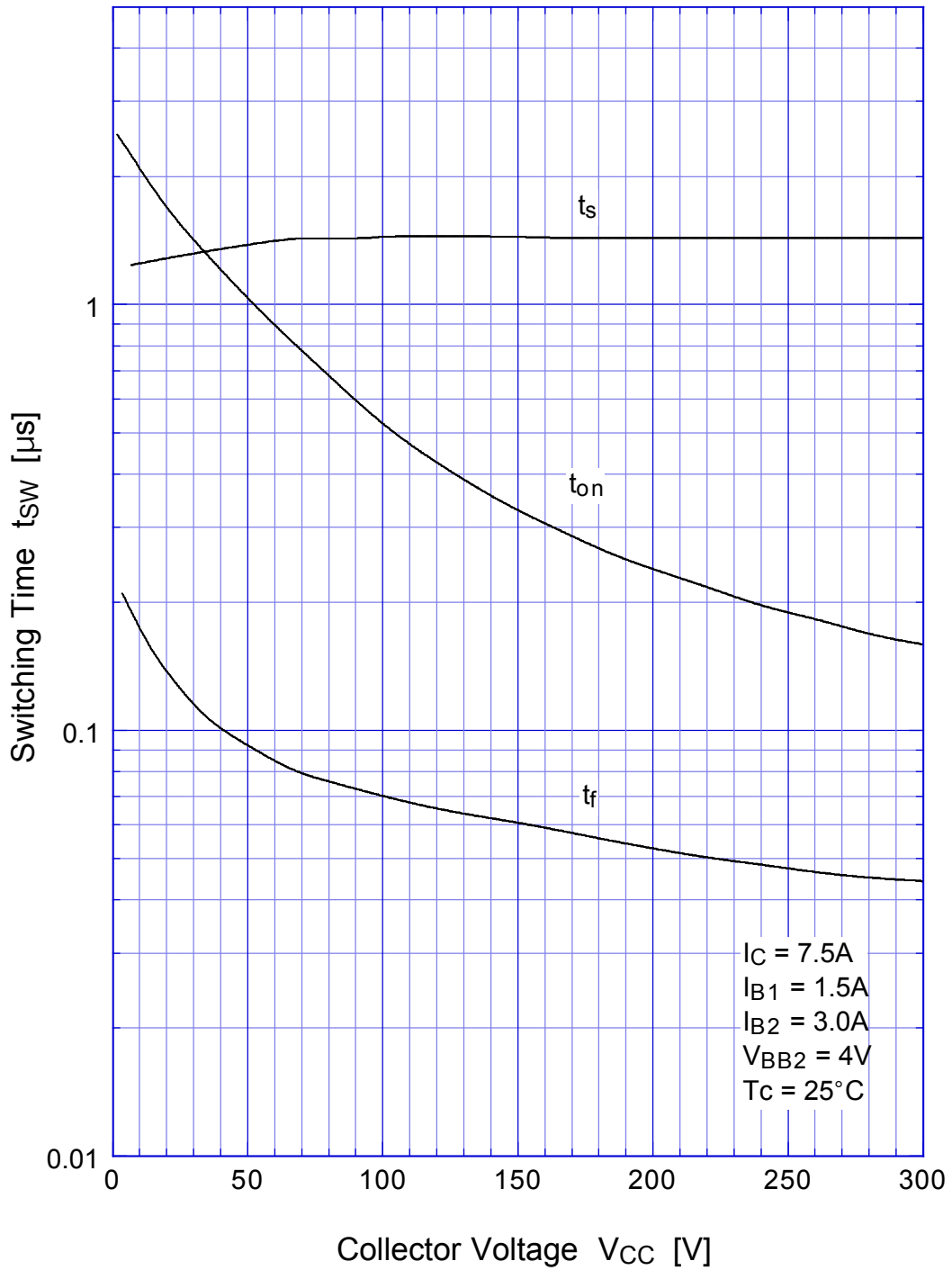

2SC4582

Switching Time - Tc

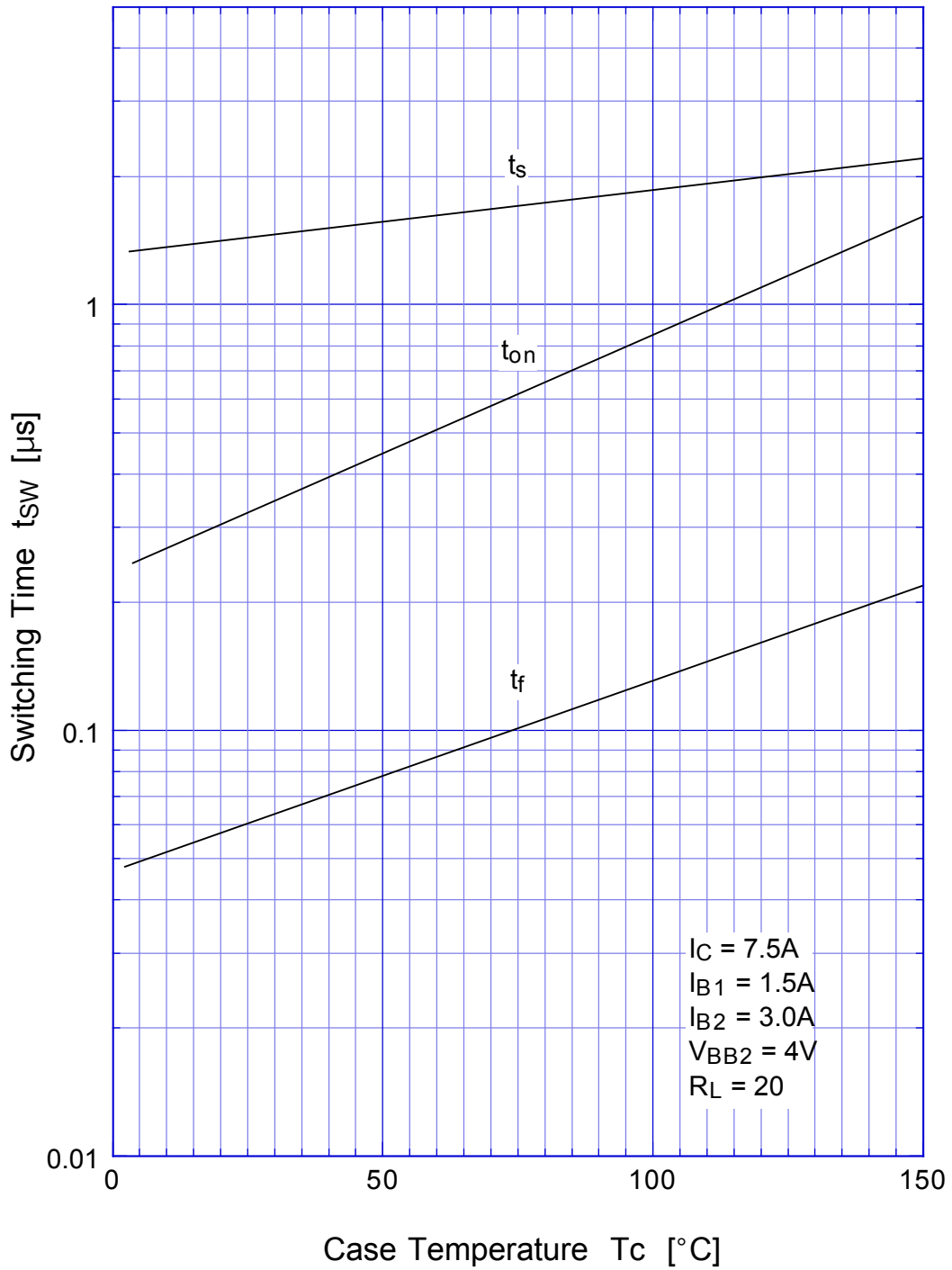

2SC4582 Transient Thermal Impedance

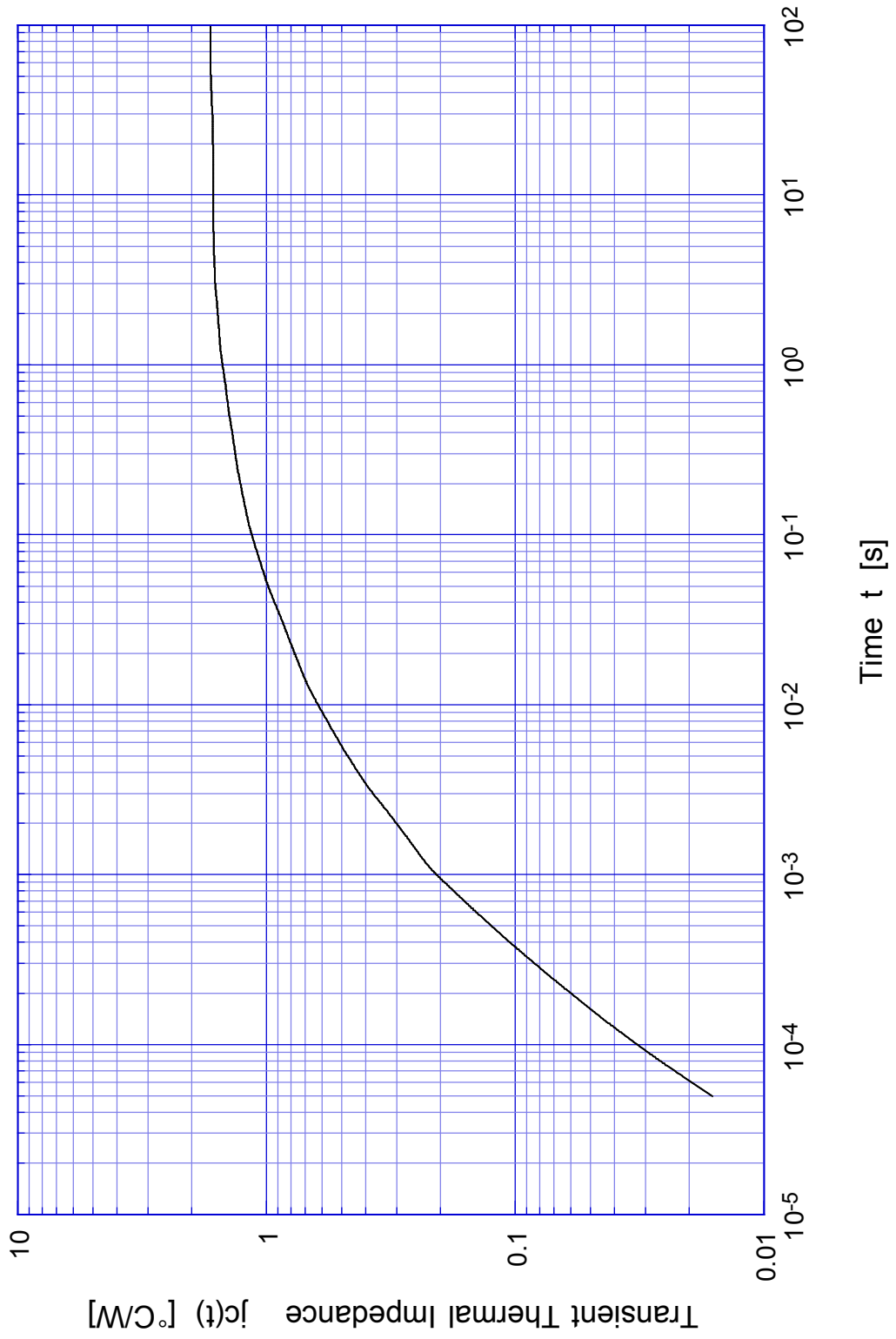

2SC4582 Forward Bias SOA

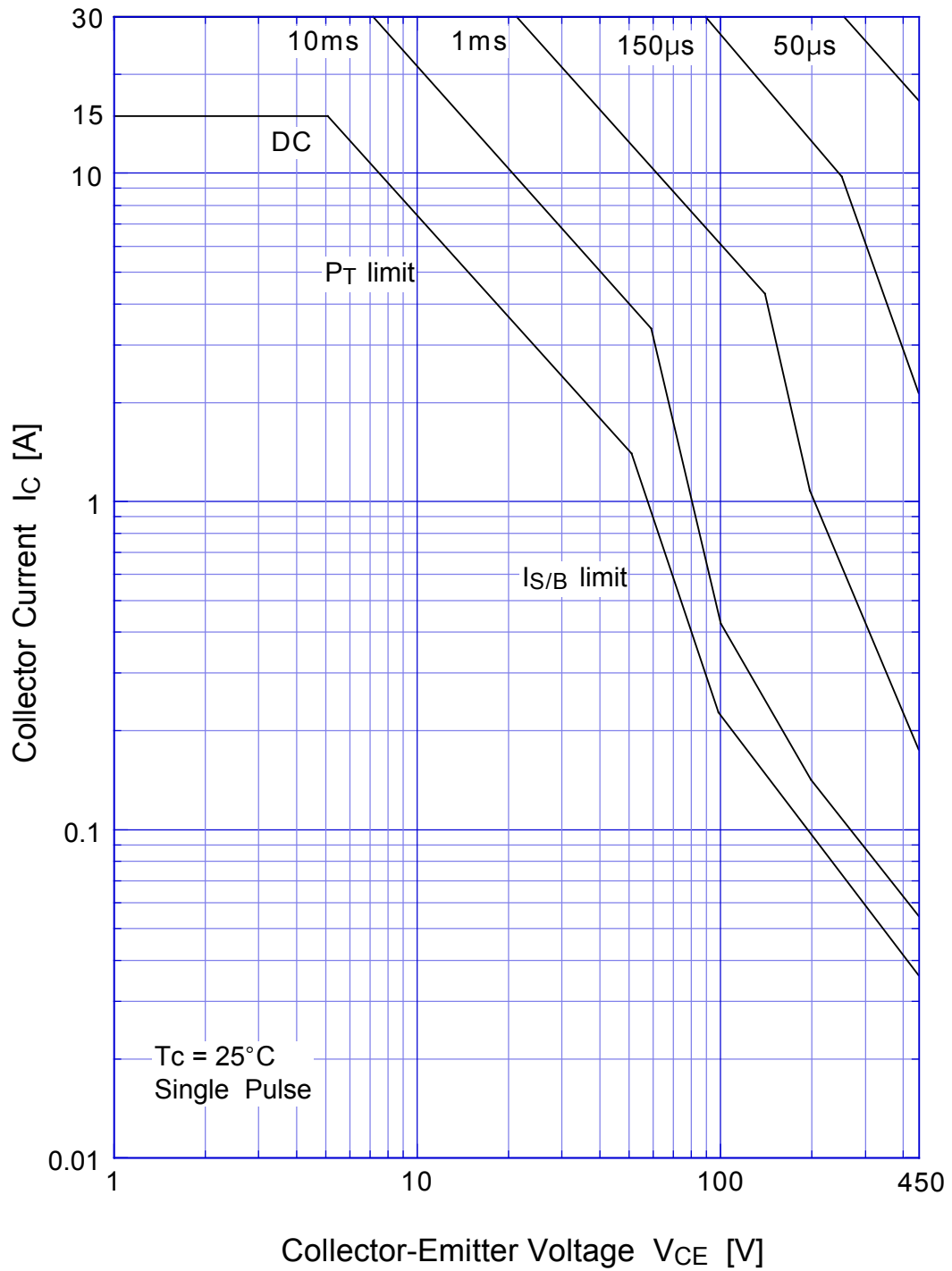

2SC4582 Collector Current Derating

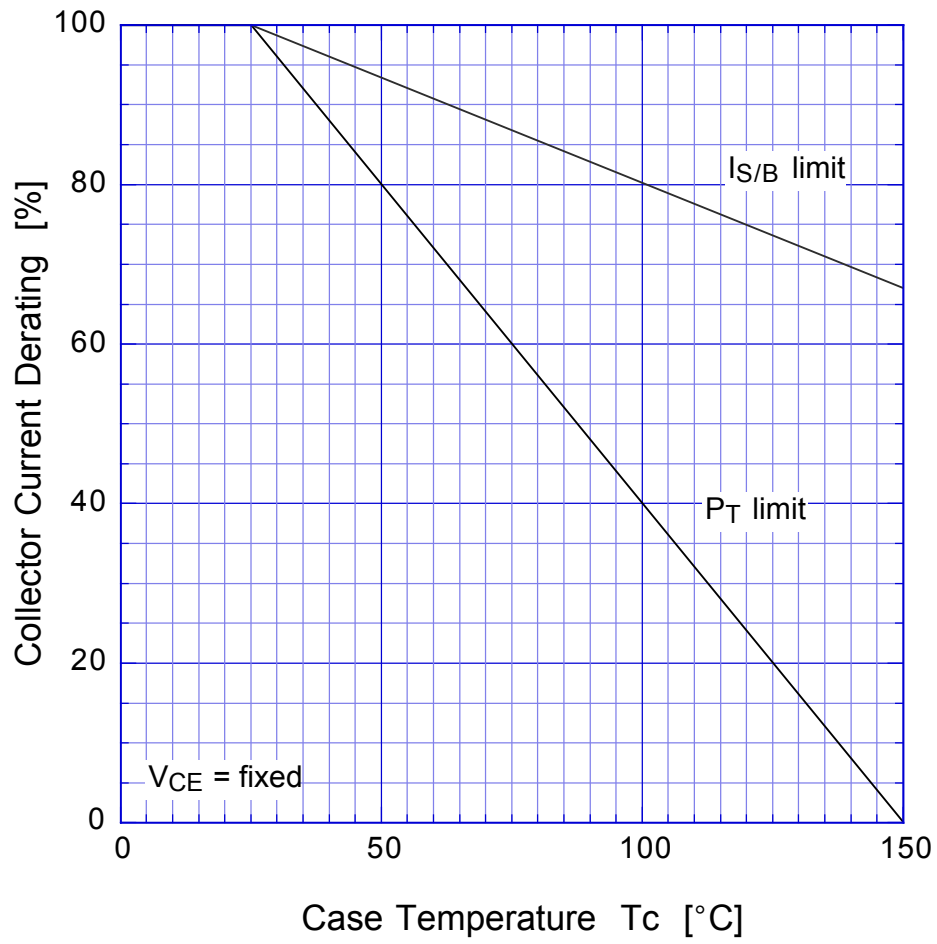

2SC4582

Reverse Bias SOA

