

DIODE MODULE

DD40F/KD40F

UL:E76102(M)

Power Diode Module **DD40F** series are designed for various rectifier circuits. **DD40F** has two diode chips connected in series in 25mm (1inch) width package and the mounting base is electrically isolated from elements for simple heatsink construction. Wide voltage rating up to, 1,600V is available for various input voltage.

- Isolated mounting base
- Two elements in a package for simple (single and three phase) bridge connections
- Highly reliable glass passivated chips
- High surge current capability

(Applications)

Various rectifiers, Battery chargers, DC motor drives

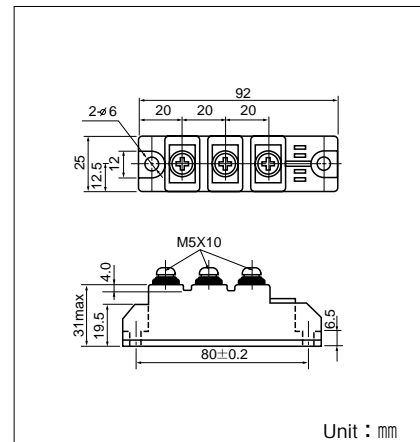
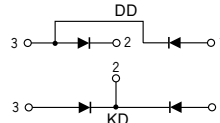

Unit : mm

Maximum Ratings

(T_j=25°C unless otherwise specified)

Symbol	Item	Ratings				Unit
		DD40F40	DD40F80	DD40F120	DD40F160	
V _{RRM}	Repetitive Peak Reverse Voltage	400	800	1200	1600	V
V _{RSM}	Non-Repetitive Peak Reverse Voltage	480	960	1300	1700	V

Symbol	Item	Conditions	Ratings	Unit
I _{F(AV)}	Average Forward Current	Single phase, half wave, 180° conduction, T _c : 96°C	40	A
I _{F(RMS)}	R.M.S. Forward Current	Single phase, half wave, 180° conduction, T _c : 96°C	62	A
I _{FSM}	Surge Forward Current	½ cycle, 50/60Hz, peak Value, non-repetitive	1200/1300	A
I ² t	I ² t	Value for one cycle of surge current	7200	A ² S
V _{ISO}	Isolation Breakdown Voltage (R.M.S.)	A.C.1minute	2500	°C
T _j	Junction Temperature		-40 to +125	°C
T _{stg}	Storage Temperature		-40 to +125	V
Mounting Torque	Mounting (M5)	Recommended Value 1.5-2.5 (15-25)	2.7 (28)	N·m (kgf·cm)
	Terminal (M5)	Recommended Value 1.5-2.5 (15-25)	2.7 (28)	
	Mass		170	g

Electrical Characteristics

Symbol	Item	Conditions	Ratings	Unit
I _{RRM}	Repetitive Peak Reverse Current, max.	at V _{DRM} , single phase, half wave. T _j =125°C	15	mA
V _{FM}	Forward Voltage Drop, max.	Forward current 120A, T _j =25°C, Inst. measurement	1.40	V
R _{th(j-c)}	Thermal Impedance, max.	Junction to case	0.55	°C/W

