

2mm Square Isolator

P/N:ESMI-V2KA1880M01-T

(1) (2) (3) (4) (5) (6) (7) (8)

for UMTS BAND 2

- (1) Series code
- (2) Size >> V2:2.0x2.0mm
- (3) Height >> K:1.0mm
- (4) Model code
- (5) Center Frequency
- (6) M : MHz / G : GHz
- (7) Control No.
- (8) T : Taping / Blank : Bulk

Specification

Frequency	1850-1910 MHz
Insertion Loss_1*	0.6 dB max
Insertion Loss_2	0.7 dB max
Isolation	10 dB min
VSWR_In	1.5 max
VSWR_Out	1.6 max
Attenuation 2f	10 dB min
Attenuation 3f	15 dB min
Handling Power	2.5 W max
Reflection Power	0.6 W max
Operating temperature	-35 to +85 deg.C
Weight	0.019 g
Reel size	φ 330 mm
Minimum Quantity	4,000 pcs /reel

* at +20 to +30 (deg.C)

Dimensions

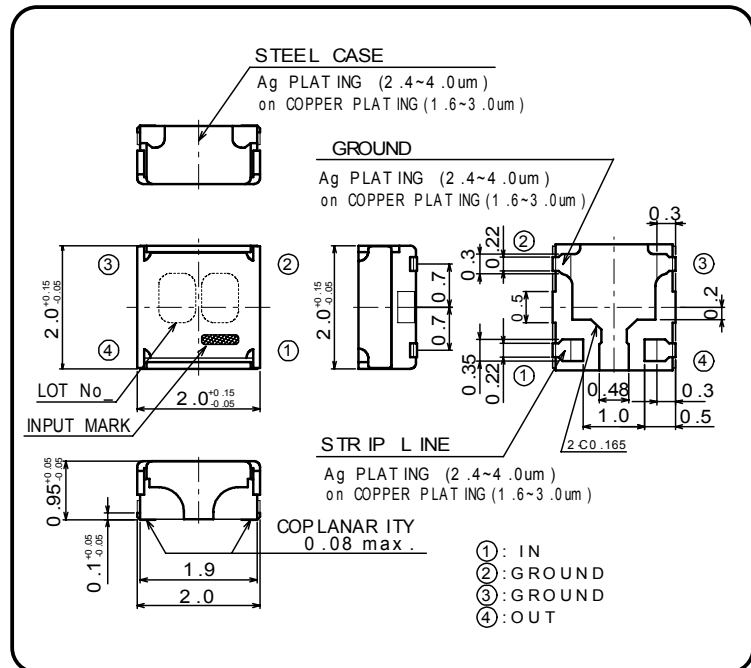

Appearance

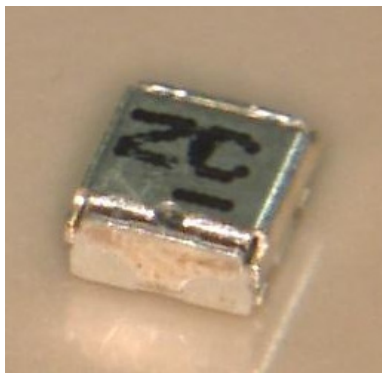

Land pattern

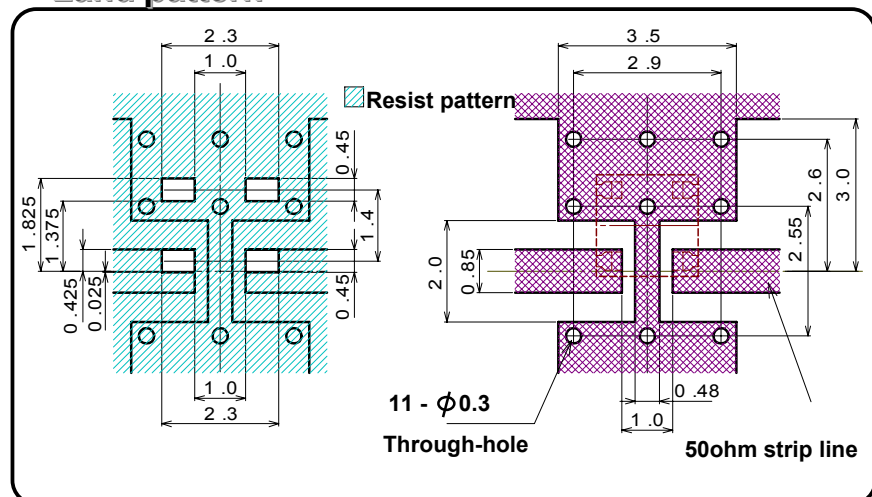

Confidential

The contents of this document is the property of Hitachi metals, Ltd. and may not be communicated to any other party in any form without the prior written contents of Hitachi Metals, Ltd..