

## Dual LDO with Low Noise, Low $I_Q$ , and High PSRR

ISL9014A is a high performance dual LDO capable of sourcing 300mA current from both outputs. The device has a low standby current and high-PSRR and is stable with output capacitance of 1 $\mu$ F to 10 $\mu$ F with ESR of up to 200m $\Omega$ .

A reference bypass pin allows an external capacitor for adjusting a noise filter for low noise and high PSRR applications.

The quiescent current is typically only 45 $\mu$ A with both LDOs enabled and active. Separate enable pins control each individual LDO output. When both enable pins are low, the device is in shutdown, typically drawing less than 0.1 $\mu$ A.

Several combinations of voltage outputs are standard. Others are available on request. Output voltage options for each LDO range from 1.2V to 3.6V.

## Pinout

**ISL9014A**  
(10 LD 3x3 DFN)  
TOP VIEW

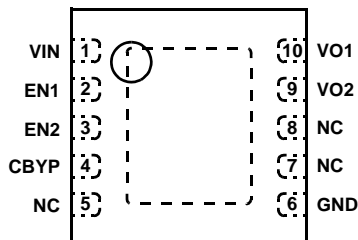

## Features

- Integrates two high performance LDOs
  - VO1 - 300mA output
  - VO2 - 300mA output
- Excellent transient response to large current steps
- Excellent load regulation: <1% voltage change across full range of load current
- High PSRR: 70dB @ 1kHz
- Wide input voltage capability: 2.3V to 6.5V
- Extremely low quiescent current: 45 $\mu$ A (both LDOs active)
- Low dropout voltage: typically 200mV @ 300mA
- Low output noise: typically 30 $\mu$ V<sub>RMS</sub> @ 100 $\mu$ A (1.5V)
- Stable with 1 $\mu$ F to 10 $\mu$ F ceramic capacitors
- Separate enable pins for each LDO
- Soft-start to limit input current surge during enable
- Current limit and overheat protection
- $\pm$ 1.8% accuracy over all operating conditions
- Tiny 10 Ld 3mmx3mm DFN package
- -40°C to +85°C operating temperature range
- Pin compatible with Micrel MIC2211
- Pb-free plus anneal available (RoHS compliant)

## Applications

- PDAs, Cell Phones and Smart Phones
- Portable Instruments, MP3 Players
- Handheld Devices including Medical Handhelds

## Ordering Information

| PART NUMBER<br>(Notes 1, 2, 3) | PART MARKING | VO1 VOLTAGE | VO2 VOLTAGE | TEMP RANGE (°C) | PACKAGE<br>(Pb-Free) | PKG. DWG. # |
|--------------------------------|--------------|-------------|-------------|-----------------|----------------------|-------------|
| ISL9014AIRNNZ                  | DKNA         | 3.3V        | 3.3V        | -40 to +85      | 10 Ld 3x3 DFN        | L10.3x3C    |
| ISL9014AIRNJZ                  | DKMA         | 3.3V        | 2.8V        | -40 to +85      | 10 Ld 3x3 DFN        | L10.3x3C    |
| ISL9014AIRNFZ                  | DKLA         | 3.3V        | 2.5V        | -40 to +85      | 10 Ld 3x3 DFN        | L10.3x3C    |
| ISL9014AIRNCZ                  | DKKA         | 3.3V        | 1.8V        | -40 to +85      | 10 Ld 3x3 DFN        | L10.3x3C    |
| ISL9014AIRMNZ                  | DKJA         | 3.0V        | 3.3V        | -40 to +85      | 10 Ld 3x3 DFN        | L10.3x3C    |
| ISL9014AIRMMZ                  | DKHA         | 3.0V        | 3.0V        | -40 to +85      | 10 Ld 3x3 DFN        | L10.3x3C    |
| ISL9014AIRMGZ                  | DKGA         | 3.0V        | 2.7V        | -40 to +85      | 10 Ld 3x3 DFN        | L10.3x3C    |
| ISL9014AIRLLZ                  | DKFA         | 2.9V        | 2.9V        | -40 to +85      | 10 Ld 3x3 DFN        | L10.3x3C    |
| ISL9014AIRKNZ                  | DKDA         | 2.85V       | 3.3V        | -40 to +85      | 10 Ld 3x3 DFN        | L10.3x3C    |
| ISL9014AIRKKZ                  | DKCA         | 2.85V       | 2.85V       | -40 to +85      | 10 Ld 3x3 DFN        | L10.3x3C    |
| ISL9014AIRKJZ                  | DKBA         | 2.85V       | 2.8V        | -40 to +85      | 10 Ld 3x3 DFN        | L10.3x3C    |
| ISL9014AIRKFZ                  | DJYA         | 2.85V       | 2.5V        | -40 to +85      | 10 Ld 3x3 DFN        | L10.3x3C    |
| ISL9014AIRKPZ                  | DKEA         | 2.85V       | 1.85V       | -40 to +85      | 10 Ld 3x3 DFN        | L10.3x3C    |
| ISL9014AIRKCZ                  | DJWA         | 2.85V       | 1.8V        | -40 to +85      | 10 Ld 3x3 DFN        | L10.3x3C    |
| ISL9014AIRJNZ                  | DJTA         | 2.8V        | 3.3V        | -40 to +85      | 10 Ld 3x3 DFN        | L10.3x3C    |
| ISL9014AIRJMZ                  | DJSA         | 2.8V        | 3.0V        | -40 to +85      | 10 Ld 3x3 DFN        | L10.3x3C    |
| ISL9014AIRJRZ                  | DJVA         | 2.8V        | 2.6V        | -40 to +85      | 10 Ld 3x3 DFN        | L10.3x3C    |
| ISL9014AIRJCZ                  | DJRA         | 2.8V        | 1.8V        | -40 to +85      | 10 Ld 3x3 DFN        | L10.3x3C    |
| ISL9014AIRJBZ                  | DJPA         | 2.8V        | 1.5V        | -40 to +85      | 10 Ld 3x3 DFN        | L10.3x3C    |
| ISL9014AIRGPZ                  | DJNA         | 2.7V        | 1.85V       | -40 to +85      | 10 Ld 3x3 DFN        | L10.3x3C    |
| ISL9014AIRGCZ                  | DJMA         | 2.7V        | 1.8V        | -40 to +85      | 10 Ld 3x3 DFN        | L10.3x3C    |
| ISL9014AIRFJZ                  | DJLA         | 2.5V        | 2.8V        | -40 to +85      | 10 Ld 3x3 DFN        | L10.3x3C    |
| ISL9014AIRFDZ                  | DJKA         | 2.5V        | 2.0V        | -40 to +85      | 10 Ld 3x3 DFN        | L10.3x3C    |
| ISL9014AIRFCZ                  | DJJA         | 2.5V        | 1.8V        | -40 to +85      | 10 Ld 3x3 DFN        | L10.3x3C    |
| ISL9014AIRPLZ                  | DKPA         | 1.85V       | 2.9V        | -40 to +85      | 10 Ld 3x3 DFN        | L10.3x3C    |
| ISL9014AIRPPZ                  | DKRA         | 1.85V       | 1.85V       | -40 to +85      | 10 Ld 3x3 DFN        | L10.3x3C    |
| ISL9014AIRCJZ                  | DJHA         | 1.8V        | 2.8V        | -40 to +85      | 10 Ld 3x3 DFN        | L10.3x3C    |
| ISL9014AIRCCZ                  | DJGA         | 1.8V        | 1.8V        | -40 to +85      | 10 Ld 3x3 DFN        | L10.3x3C    |
| ISL9014AIRBLZ                  | DJFA         | 1.5V        | 2.9V        | -40 to +85      | 10 Ld 3x3 DFN        | L10.3x3C    |
| ISL9014AIRBJZ                  | DJEA         | 1.5V        | 2.8V        | -40 to +85      | 10 Ld 3x3 DFN        | L10.3x3C    |
| ISL9014AIRBCZ                  | DJDA         | 1.5V        | 1.8V        | -40 to +85      | 10 Ld 3x3 DFN        | L10.3x3C    |
| ISL9014AIRBBZ                  | DJCA         | 1.5V        | 1.5V        | -40 to +85      | 10 Ld 3x3 DFN        | L10.3x3C    |

## NOTES:

1. Add "-T" to part number for tape and reel.
2. For availability and lead time of devices with voltage combinations not listed in the table, contact Intersil Marketing.
3. Intersil Pb-free plus anneal products employ special Pb-free material sets; molding compounds/die attach materials and 100% matte tin plate termination finish, which are RoHS compliant and compatible with both SnPb and Pb-free soldering operations. Intersil Pb-free products are MSL classified at Pb-free peak reflow temperatures that meet or exceed the Pb-free requirements of IPC/JEDEC J STD-020.

**Absolute Maximum Ratings**

Supply Voltage (VIN) ..... +7.1V  
 All Other Pins ..... -0.3 to (VIN+0.3)V

**Recommended Operating Conditions**

Ambient Temperature Range (TA) ..... -40°C to +85°C  
 Supply Voltage (VIN) ..... 2.3V to 6.5V

**Thermal Information**

Thermal Resistance (Notes 4, 5)                     $\theta_{JA}$  (°C/W)     $\theta_{JC}$  (°C/W)  
 3x3 DFN Package .....                    50                    10  
 Junction Temperature Range ..... -40°C to +125°C  
 Operating Temperature Range ..... -40°C to +85°C  
 Storage Temperature Range ..... -65°C to +150°C  
 Maximum Lead Temperature (Soldering 10s) ..... +300°C

*CAUTION: Stresses above those listed in "Absolute Maximum Ratings" may cause permanent damage to the device. This is a stress only rating and operation of the device at these or any other conditions above those indicated in the operational sections of this specification is not implied.*

NOTES:

- $\theta_{JA}$  is measured in free air with the component mounted on a high effective thermal conductivity test board with "direct attach" features. See Tech Brief TB379.
- $\theta_{JC}$ , "case temperature" location is at the center of the exposed metal pad on the package underside. See Tech Brief TB379.

**Electrical Specifications**

Unless otherwise noted, all parameters are guaranteed over the operational supply voltage and temperature range of the device as follows: TA = -40°C to +85°C; VIN = (VO + 1.0V) to 6.5V with a minimum VIN of 2.3V; CIN = 1µF; CO = 1µF; CBYP = 0.01µF

| PARAMETER                    | SYMBOL | TEST CONDITIONS  | MIN  | TYP | MAX  | UNITS |
|------------------------------|--------|--|------|-----|------|-------|
| <b>DC CHARACTERISTICS</b>    |        |  |      |     |      |       |
| Supply Voltage               | VIN    |  | 2.3  |     | 6.5  | V     |
| Ground Current               |        | Quiescent condition: IO1 = 0µA; IO2 = 0µA  |      |     |      |       |
|                              | IDD1   | One LDO active   |      | 25  | 40   | µA    |
|                              | IDD2   | Both LDO active  |      | 45  | 60   | µA    |
| Shutdown Current             | IDDS   | @ +25°C  |      | 0.1 | 1.0  | µA    |
| UVLO Threshold               | VUV+   |  | 1.9  | 2.1 | 2.3  | V     |
|                              | VUV-   |  | 1.6  | 1.8 | 2.0  | V     |
| Regulation Voltage Accuracy  |        | Variation from nominal voltage output, VIN = VO + 0.5V to 5.5V, TJ = -40°C to +125°C | -1.8 |     | +1.8 | %     |
| Line Regulation              |        | VIN = (VOOUT + 1.0V relative to highest output voltage) to 5.5V                      | -0.2 | 0   | 0.2  | %/V   |
| Load Regulation              |        | IOOUT = 100µA to 150mA   |      | 0.1 | 0.7  | %     |
|                              |        | IOOUT = 100µA to 300mA   |      |     | 1.0  | %     |
| Maximum Output Current       | IMAX   | VO1: Continuous  | 300  |     |      | mA    |
|                              |        | VO2: Continuous  | 300  |     |      | mA    |
| Internal Current Limit       | ILIM   |  | 350  | 475 | 600  | mA    |
| Dropout Voltage (Note 6)     | VDO1   | IO = 150mA; VO > 2.1V  |      | 125 | 200  | mV    |
|                              | VDO2   | IO = 300mA; VO < 2.5V  |      | 300 | 500  | mV    |
|                              | VDO3   | IO = 300mA; 2.5V ≤ VO ≤ 2.8V   |      | 250 | 400  | mV    |
|                              | VDO4   | IO = 300mA; VO > 2.8V  |      | 200 | 325  | mV    |
| Thermal Shutdown Temperature | TSD+   |  |      | 145 |      | °C    |
|                              | TSD-   |  |      | 110 |      | °C    |
| <b>AC CHARACTERISTICS</b>    |        |  |      |     |      |       |
| Ripple Rejection             |        | IO = 10mA, VIN = 2.8V(min), VO = 1.8V, CBYP = 0.1µF                                  |      |     |      |       |
|                              |        | @ 1kHz   |      | 70  |      | dB    |
|                              |        | @ 10kHz  |      | 55  |      | dB    |
|                              |        | @ 100kHz   |      | 40  |      | dB    |
| Output Noise Voltage         |        | IO = 100µA, VO = 1.5V, TA = +25°C, CBYP = 0.1µF<br>BW = 10Hz to 100kHz               |      | 30  |      | µVRMS |

# ISL9014A

## Electrical Specifications

Unless otherwise noted, all parameters are guaranteed over the operational supply voltage and temperature range of the device as follows:  $T_A = -40^{\circ}\text{C}$  to  $+85^{\circ}\text{C}$ ;  $V_{IN} = (V_O + 1.0\text{V})$  to  $6.5\text{V}$  with a minimum  $V_{IN}$  of  $2.3\text{V}$ ;  $C_{IN} = 1\mu\text{F}$ ;  $C_O = 1\mu\text{F}$ ;  $C_{BYP} = 0.01\mu\text{F}$  **(Continued)**

| PARAMETER                              | SYMBOL           | TEST CONDITIONS  | MIN  | TYP | MAX            | UNITS                  |
|--|------------------|--|------|-----|----------------|------------------------|
| <b>DEVICE START-UP CHARACTERISTICS</b> |                  |  |      |     |                |                        |
| Device Enable Time                     | $t_{EN}$         | Time from assertion of the ENx pin to when the output voltage reaches 95% of the $V_O(\text{nom})$ |      | 250 | 500            | $\mu\text{s}$          |
| LDO Soft-Start Ramp Rate               | $t_{SSR}$        | Slope of linear portion of LDO output voltage ramp during start-up                                 |      | 30  | 60             | $\mu\text{s}/\text{V}$ |
| <b>EN1, EN2 PIN CHARACTERISTICS</b>    |                  |  |      |     |                |                        |
| Input Low Voltage                      | $V_{IL}$         |  | -0.3 |     | 0.5            | V                      |
| Input High Voltage                     | $V_{IH}$         |  | 1.4  |     | $V_{IN} + 0.3$ | V                      |
| Input Leakage Current                  | $I_{IL}, I_{IH}$ |  |      |     | 0.1            | $\mu\text{A}$          |
| Pin Capacitance                        | $C_{PIN}$        | Informative  |      | 5   |                | pF                     |

### NOTES:

- $V_{OX} = 0.98 * V_{OX}(\text{NOM})$ ; Valid for  $V_{OX}$  greater than  $1.85\text{V}$ .

Typical Performance Curves

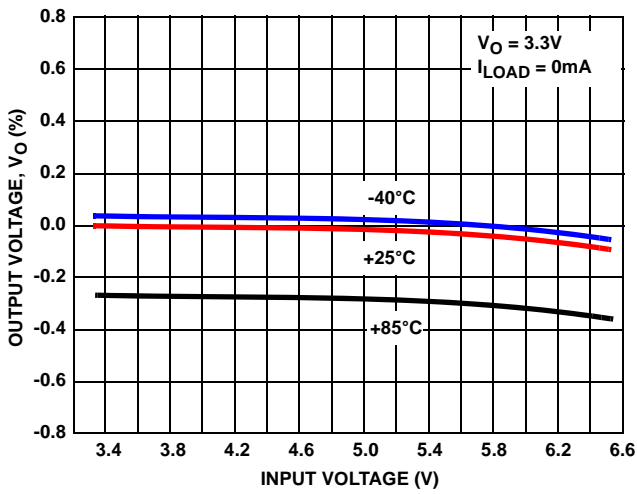

FIGURE 1. OUTPUT VOLTAGE vs INPUT VOLTAGE (3.3V OUTPUT)

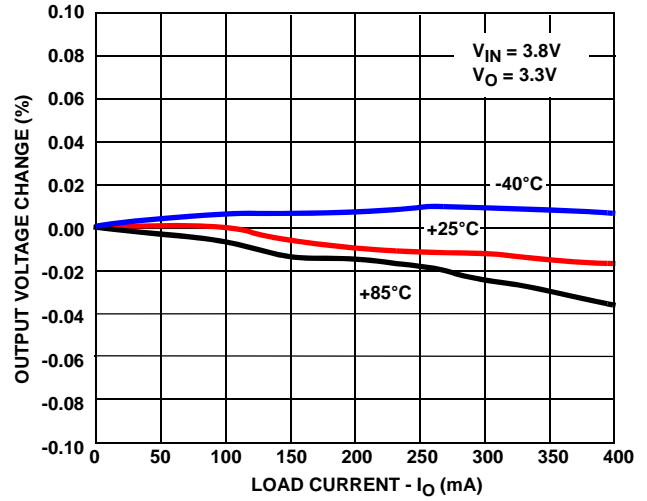

FIGURE 2. OUTPUT VOLTAGE CHANGE vs LOAD CURRENT

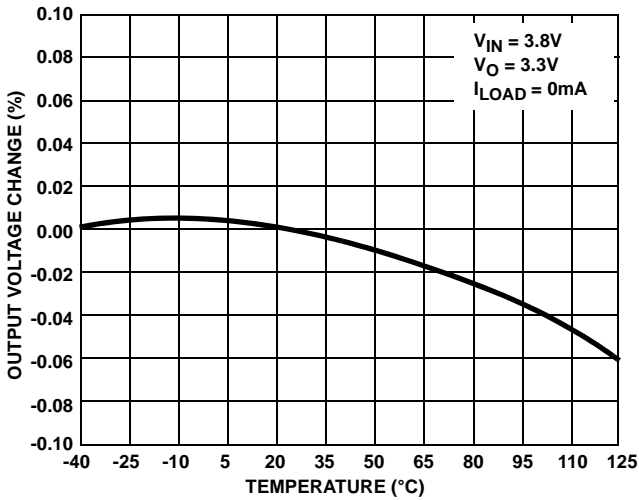

FIGURE 3. OUTPUT VOLTAGE CHANGE vs TEMPERATURE

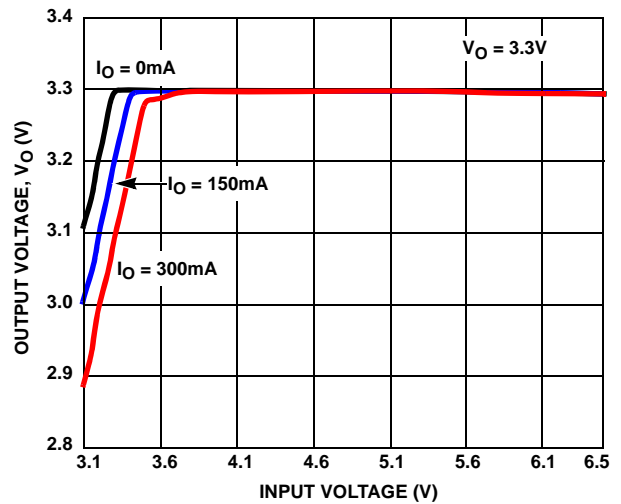

FIGURE 4. OUTPUT VOLTAGE vs INPUT VOLTAGE (3.3V OUTPUT)

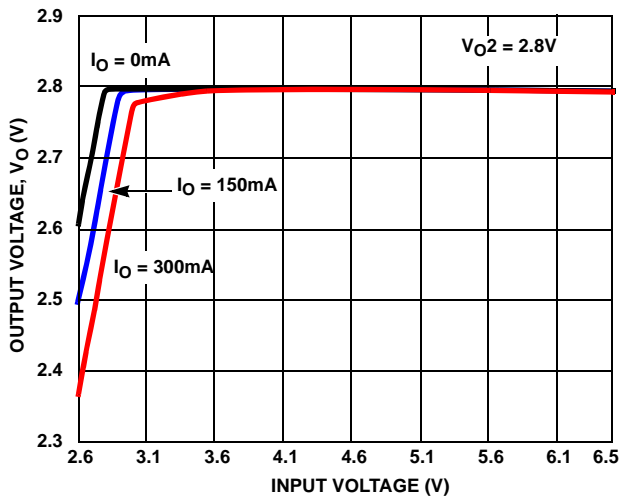

FIGURE 5. OUTPUT VOLTAGE vs INPUT VOLTAGE (V<sub>O2</sub> = 2.8V)

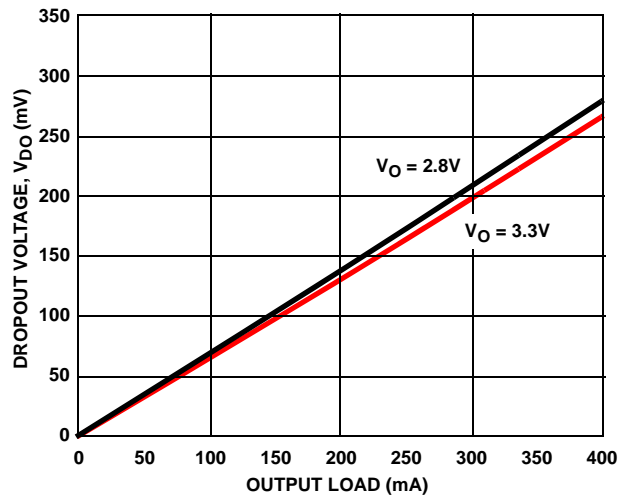

FIGURE 6. DROPOUT VOLTAGE vs LOAD CURRENT

Typical Performance Curves (Continued)

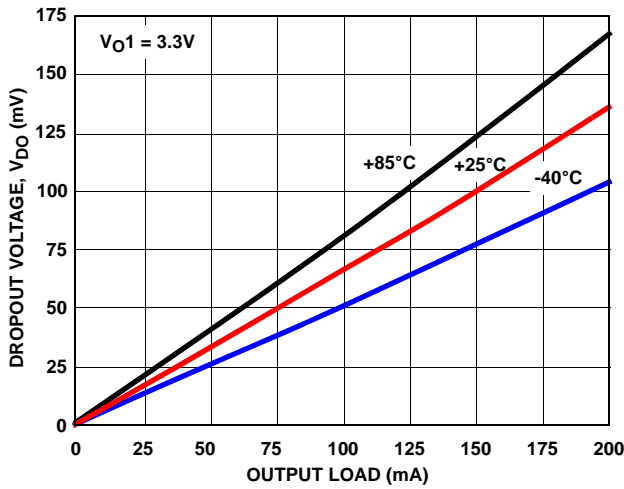

FIGURE 7. VO1 DROPOUT VOLTAGE vs LOAD CURRENT

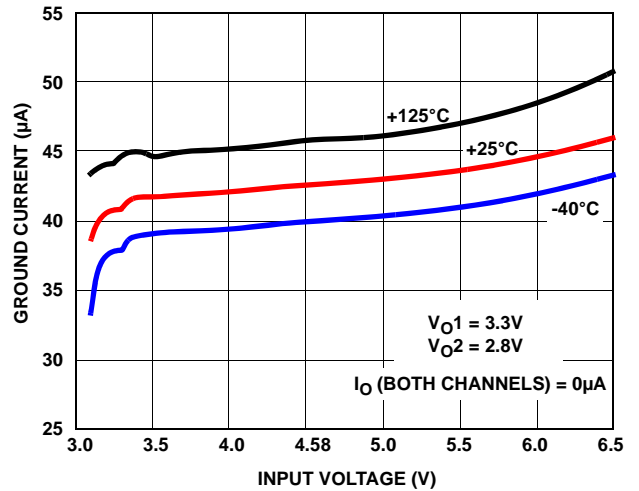

FIGURE 8. GROUND CURRENT vs INPUT VOLTAGE

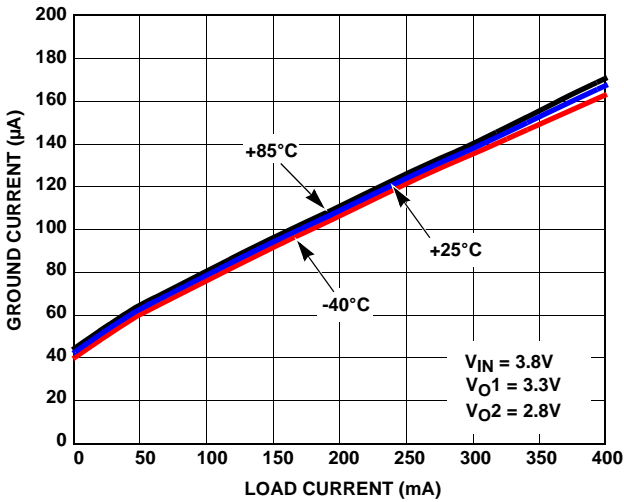

FIGURE 9. GROUND CURRENT vs LOAD

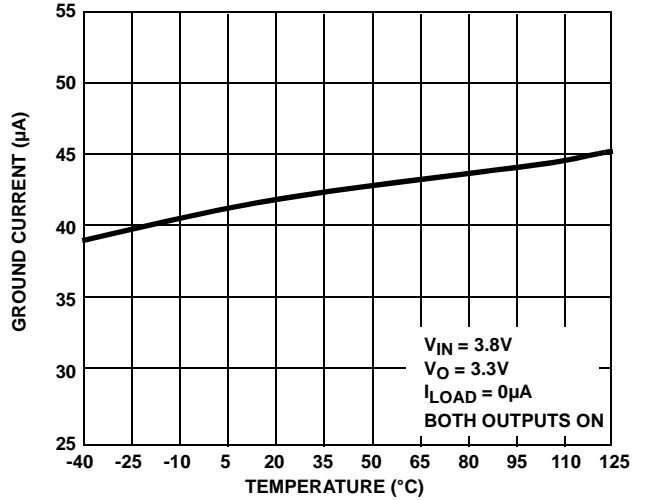

FIGURE 10. GROUND CURRENT vs TEMPERATURE

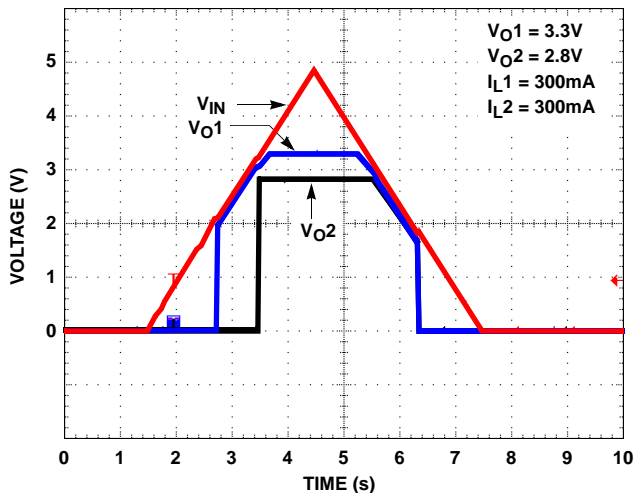

FIGURE 11. POWER-UP/POWER-DOWN

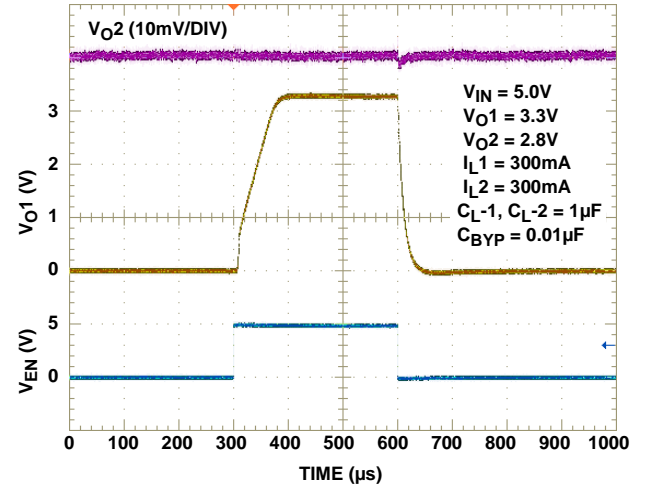

FIGURE 12. TURN-ON/TURN-OFF RESPONSE

Typical Performance Curves (Continued)

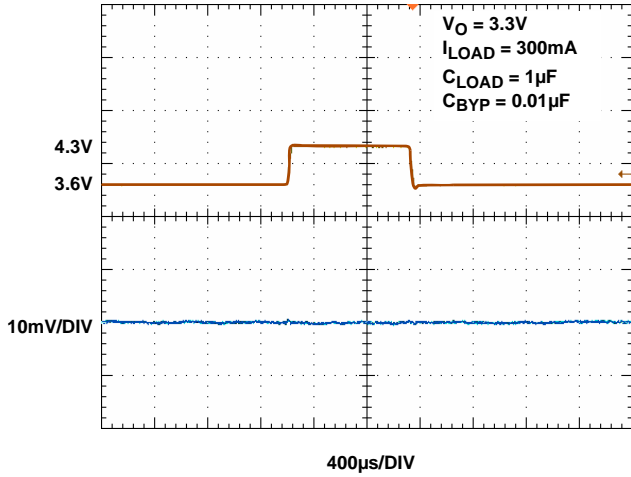

FIGURE 13. LINE TRANSIENT RESPONSE, 3.3V OUTPUT

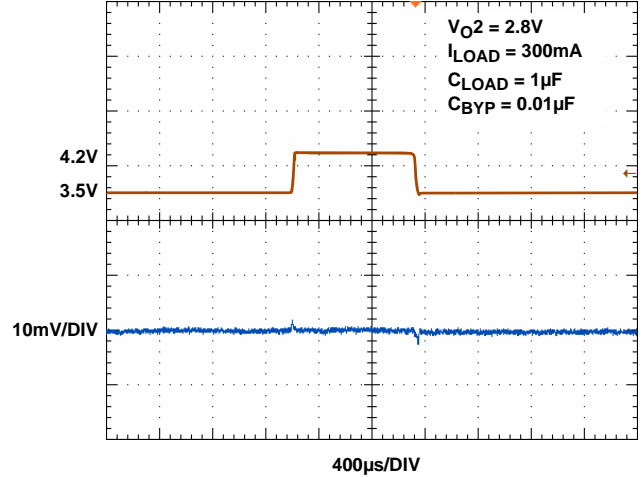

FIGURE 14. LINE TRANSIENT RESPONSE, 2.8V OUTPUT

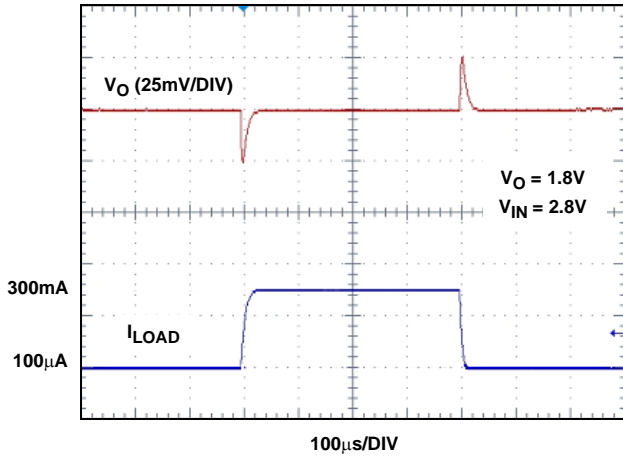

FIGURE 15. LOAD TRANSIENT RESPONSE

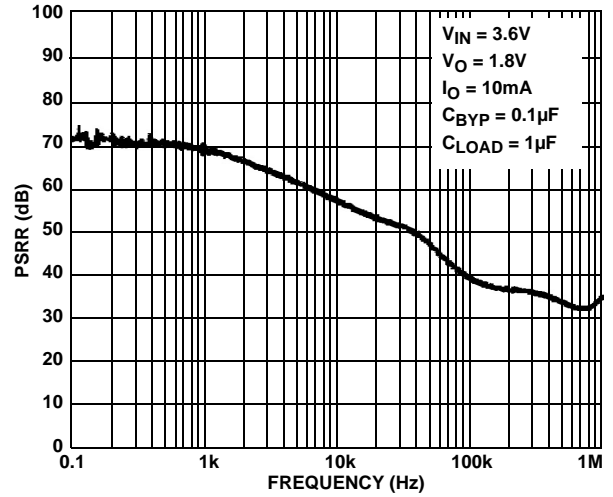

FIGURE 16. PSRR vs FREQUENCY

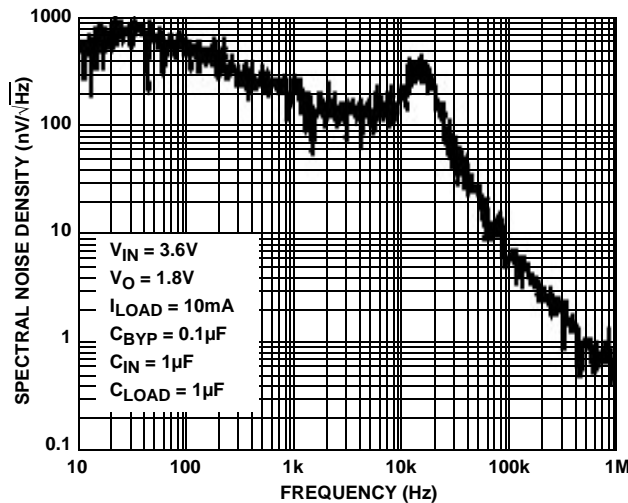
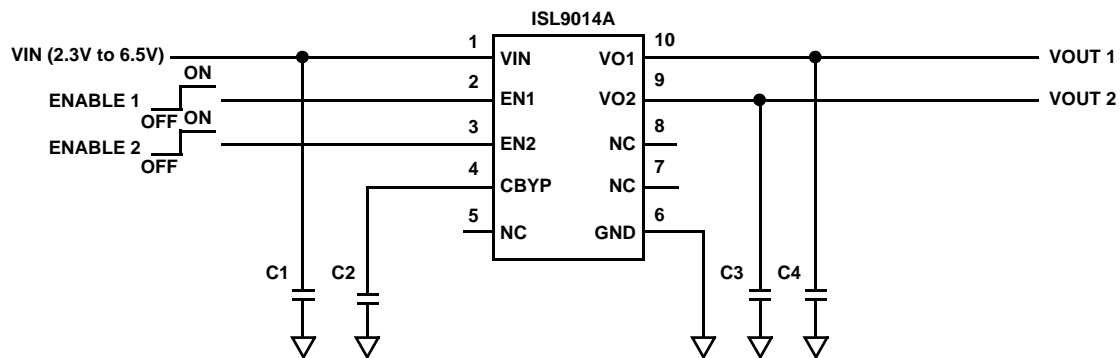

FIGURE 17. SPECTRAL NOISE DENSITY vs FREQUENCY

**Pin Description**

| PIN #   | PIN NAME | TYPE                              | DESCRIPTION  |
|---------|----------|-----------------------------------|--|
| 1       | VIN      | Analog I/O                        | Supply Voltage/LDO Input:<br>Connect a 1 $\mu$ F capacitor to GND.   |
| 2       | EN1      | Low Voltage Compatible CMOS Input | LDO-1 Enable.  |
| 3       | EN2      | Low Voltage Compatible CMOS Input | LDO-2 Enable.  |
| 4       | CBYP     | Analog I/O                        | Reference Bypass Capacitor Pin:<br>Optionally connect capacitor of value 0.01 $\mu$ F to 1 $\mu$ F between this pin and GND to tune in the desired noise and PSRR performance. |
| 5, 7, 8 | NC       | NC                                | No Connection  |
| 6       | GND      | Ground                            | GND is the connection to system ground. Connect to PCB Ground plane.   |
| 9       | VO2      | Analog I/O                        | LDO-2 Output: Connect capacitor of value 1 $\mu$ F to 10 $\mu$ F to GND (1 $\mu$ F recommended).   |
| 10      | VO1      | Analog I/O                        | LDO-1 Output: Connect capacitor of value 1 $\mu$ F to 10 $\mu$ F to GND (1 $\mu$ F recommended).   |

**Typical Application**



C1, C3, C4: 1 $\mu$ F X5R ceramic capacitor  
 C2: 0.1 $\mu$ F X5R ceramic capacitor



## Block Diagram

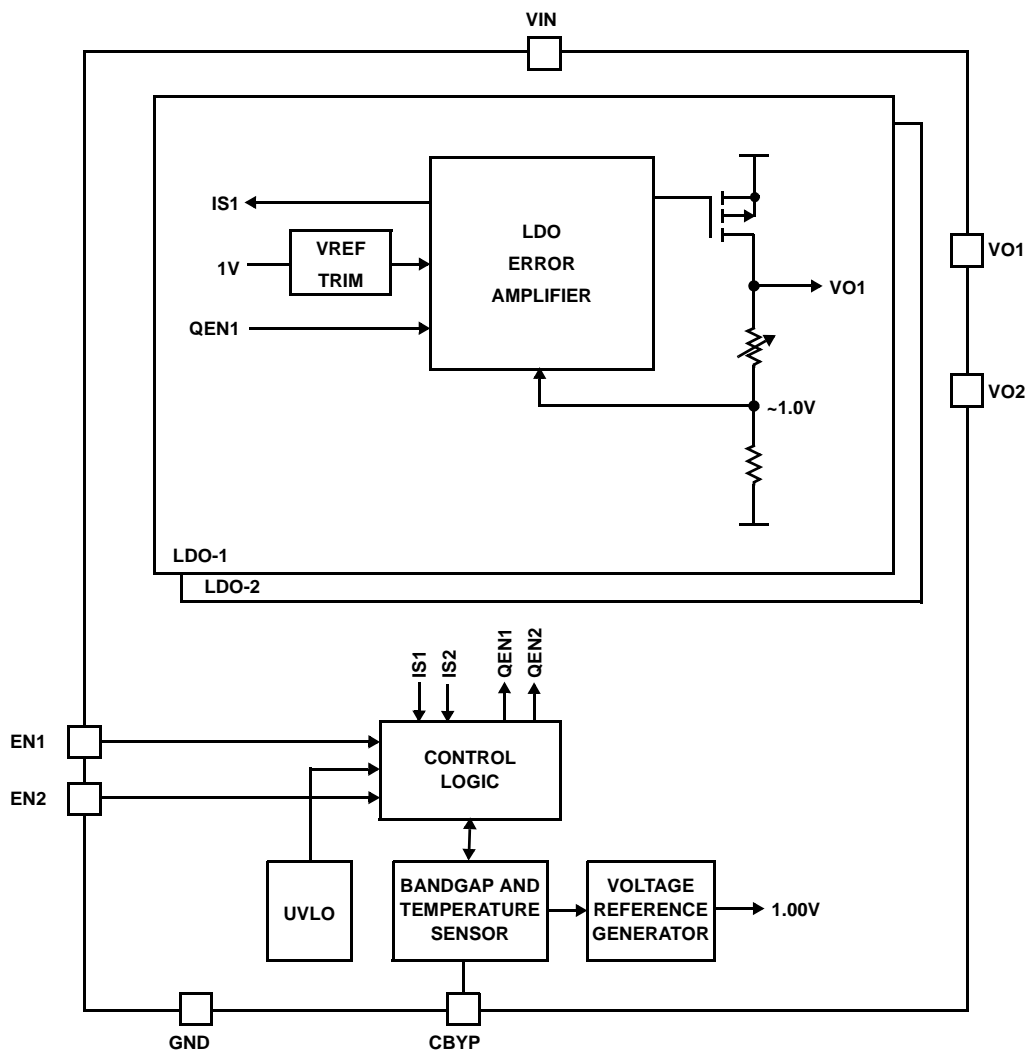

### Functional Description

The ISL9014A contains all circuitry required to implement two high performance LDO's. High performance is achieved through a circuit that delivers fast transient response to varying load conditions. In a quiescent condition, the ISL9014A adjusts its biasing to achieve the lowest standby current consumption.

The device also integrates current limit protection, smart thermal shutdown protection, staged turn-on and soft-start. Smart Thermal shutdown protects the device against overheating. Staged turn-on and soft-start minimize start-up input current surges without causing excessive device turn-on time.

### Power Control

The ISL9014A has two separate enable pins (EN1 and EN2) to individually control power to each of the LDO outputs. When both EN1 and EN2 are low, the device is in shutdown mode. During this condition, all on-chip circuits are off, and the device draws minimum current, typically less than 0.1  $\mu$ A.

When one or both of the enable pins are asserted, the device first polls the output of the UVLO detector to ensure that VIN voltage is at least about 2.1V. Once verified, the device initiates a start-up sequence. During the start-up sequence, trim settings are first read and latched. Then, sequentially, the bandgap, reference voltage and current generation circuitry power up. Once the references are stable, a fast-start circuit quickly charges the external reference bypass capacitor (connected to the CBYP pin) to the proper operating voltage. After the bypass capacitor has been charged, the LDO's power up.

If EN1 is brought high, and EN2 goes high before the VO1 output stabilizes, the ISL9014A delays the VO2 turn-on until the VO1 output reaches its target level.

If EN2 is brought high, and EN1 goes high before VO2 starts its output ramp, then VO1 turns on first and the ISL9014A delays the VO2 turn-on until the VO1 output reaches its target level.

If EN2 is brought high, and EN1 goes high after VO2 starts its output ramp, then the ISL9014A immediately starts to ramp up the VO1 output.

If both EN1 and EN2 are brought high at the same time, the VO1 output has priority, and is always powered up first.

During operation, whenever the VIN voltage drops below about 1.8V, the ISL9014A immediately disables both LDO outputs. When VIN rises back above 2.1V, the device re-initiates its start-up sequence and LDO operation will resume automatically.

## **Reference Generation**

The reference generation circuitry includes a trimmed bandgap, a trimmed voltage reference divider, a trimmed current reference generator, and an RC noise filter. The filter includes the external capacitor connected to the CBYP pin. A 0.01 $\mu$ F capacitor connected CBYP implements a 100Hz lowpass filter, and is recommended for most high performance applications. For the lowest noise application, a 0.1 $\mu$ F or greater CBYP capacitor should be used. This filters the reference noise to below the 10Hz to 1kHz frequency band, which is crucial in many noise-sensitive applications.

The bandgap generates a zero temperature coefficient (TC) voltage for the reference divider. The reference divider provides the regulation reference and other voltage references required for current generation and over-temperature detection.

The current generator outputs references required for adaptive biasing as well as references for LDO output current limit and thermal shutdown determination.

## **LDO Regulation and Programmable Output Divider**

The LDO Regulator is implemented with a high-gain operational amplifier driving a PMOS pass transistor. The design of the ISL9014A provides a regulator that has low quiescent current, fast transient response, and overall stability across all operating and load current conditions. LDO stability is guaranteed for a 1 $\mu$ F to 10 $\mu$ F output capacitor that has a tolerance better than 20% and ESR less than 200m $\Omega$ . The design is performance-optimized for a 1 $\mu$ F capacitor. Unless limited by the application, use of an output capacitor value above 4.7 $\mu$ F is not recommended as LDO performance improvement is minimal.

Soft-start circuitry integrated into each LDO limits the initial ramp-up rate to about 30 $\mu$ s/V to minimize current surge. The ISL9014A provides short-circuit protection by limiting the output current to about 475mA.

Each LDO uses an independently trimmed 1V reference. An internal resistor divider drops the LDO output voltage down to 1V. This is compared to the 1V reference for regulation. The resistor division ratio is programmed in the factory.

## **Overheat Detection**

The bandgap outputs a proportional-to-temperature current that is indicative of the temperature of the silicon. This current is compared with references to determine if the device is in danger of damage due to overheating. When the die temperature reaches about +145 $^{\circ}$ C, one or both of the LDO's momentarily shut down until the die cools sufficiently. In the overheat condition, only the LDO sourcing more than 50mA will be shut off. This does not affect the operation of the other LDO. If both LDOs source more than 50mA and an overheat condition occurs, both LDO outputs are disabled. Once the die temperature falls back below about +110 $^{\circ}$ C, the disabled LDO(s) are re-enabled and soft-start automatically takes place.

Dual Flat No-Lead Plastic Package (DFN)

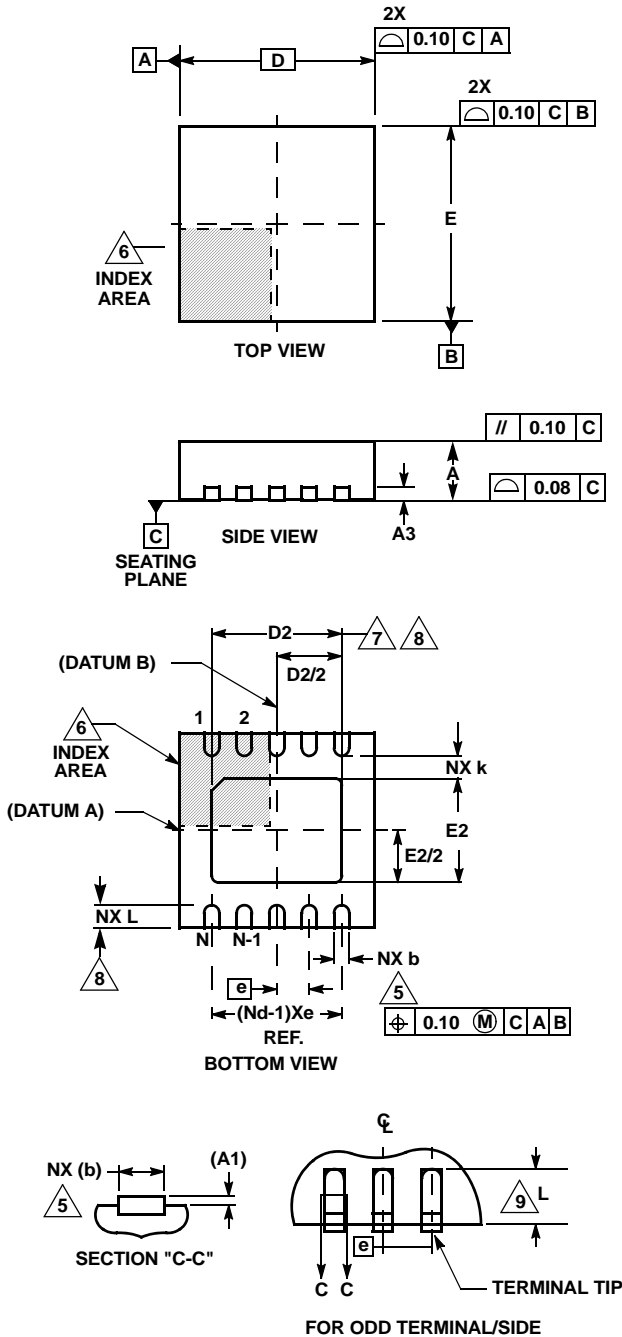

**L10.3x3C**  
10 LEAD DUAL FLAT NO-LEAD PLASTIC PACKAGE

| SYMBOL | MILLIMETERS |         |      | NOTES |
|--------|-------------|---------|------|-------|
|        | MIN         | NOMINAL | MAX  |       |
| A      | 0.85        | 0.90    | 0.95 | -     |
| A1     | -           | -       | 0.05 | -     |
| A3     | 0.20 REF    |         |      | -     |
| b      | 0.20        | 0.25    | 0.30 | 5, 8  |
| D      | 3.00 BSC    |         |      | -     |
| D2     | 2.33        | 2.38    | 2.43 | 7, 8  |
| E      | 3.00 BSC    |         |      | -     |
| E2     | 1.59        | 1.64    | 1.69 | 7, 8  |
| e      | 0.50 BSC    |         |      | -     |
| k      | 0.20        | -       | -    | -     |
| L      | 0.35        | 0.40    | 0.45 | 8     |
| N      | 10          |         |      | 2     |
| Nd     | 5           |         |      | 3     |

Rev. 1 4/06

NOTES:

1. Dimensioning and tolerancing conform to ASME Y14.5-1994.
2. N is the number of terminals.
3. Nd refers to the number of terminals on D.
4. All dimensions are in millimeters. Angles are in degrees.
5. Dimension b applies to the metallized terminal and is measured between 0.15mm and 0.30mm from the terminal tip.
6. The configuration of the pin #1 identifier is optional, but must be located within the zone indicated. The pin #1 identifier may be either a mold or mark feature.
7. Dimensions D2 and E2 are for the exposed pads which provide improved electrical and thermal performance.
8. Nominal dimensions are provided to assist with PCB Land Pattern Design efforts, see Intersil Technical Brief TB389.
9. COMPLIANT TO JEDEC MO-229-WEED-3 except for dimensions E2 & D2.

All Intersil U.S. products are manufactured, assembled and tested utilizing ISO9000 quality systems.  
Intersil Corporation's quality certifications can be viewed at [www.intersil.com/design/quality](http://www.intersil.com/design/quality)

*Intersil products are sold by description only. Intersil Corporation reserves the right to make changes in circuit design, software and/or specifications at any time without notice. Accordingly, the reader is cautioned to verify that data sheets are current before placing orders. Information furnished by Intersil is believed to be accurate and reliable. However, no responsibility is assumed by Intersil or its subsidiaries for its use; nor for any infringements of patents or other rights of third parties which may result from its use. No license is granted by implication or otherwise under any patent or patent rights of Intersil or its subsidiaries.*

For information regarding Intersil Corporation and its products, see [www.intersil.com](http://www.intersil.com)