

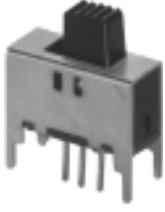

MSS Series

Standard Size Slide Switches

SPECIFICATIONS	FEATURES
<p>Contact ratings: Gold; 0.4 Volt-Amps (VA) max. at 20 V max. (AC or DC) Silver; 300 mA at 125 VAC or 30 VDC</p> <p>Initial contact resistance: 20 milliohms max.</p> <p>Insulation resistance: 100 megohms min. at 500 VDC</p> <p>Dielectric strength: 500 volts RMS at sea level</p> <p>Electrical life: 10,000 cycles min.</p> <p>Operating temperature range: -10°C to +60°C</p> <p>Solder heat resistance: 260°C max. for 3 seconds</p> <p>Solvent washing permissible</p>	<ul style="list-style-type: none"> ● Bifurcated wiping contact design. ● Epoxy sealed terminals. ● Wash-through open frame construction. ● Reinforcing mounting legs.
	MATERIALS
	<p>Contacts & terminals: Gold or silver available (see contact ratings)</p> <p>Housing: Tin/lead plated steel Actuator: Thermoplastic</p> <p>Base: Phenolic laminated sheet Terminal seal: Epoxy</p>

MODEL NO.	PLATING	
MSS12A	SILVER	<div style="text-align: center;">  <p>VERTICAL ACTUATOR</p> </div>
MSS12AG	GOLD	
MODEL NO.	PLATING	
MSS12AR	SILVER	<div style="text-align: center;">  <p>RIGHT ANGLE ACTUATOR</p> </div>

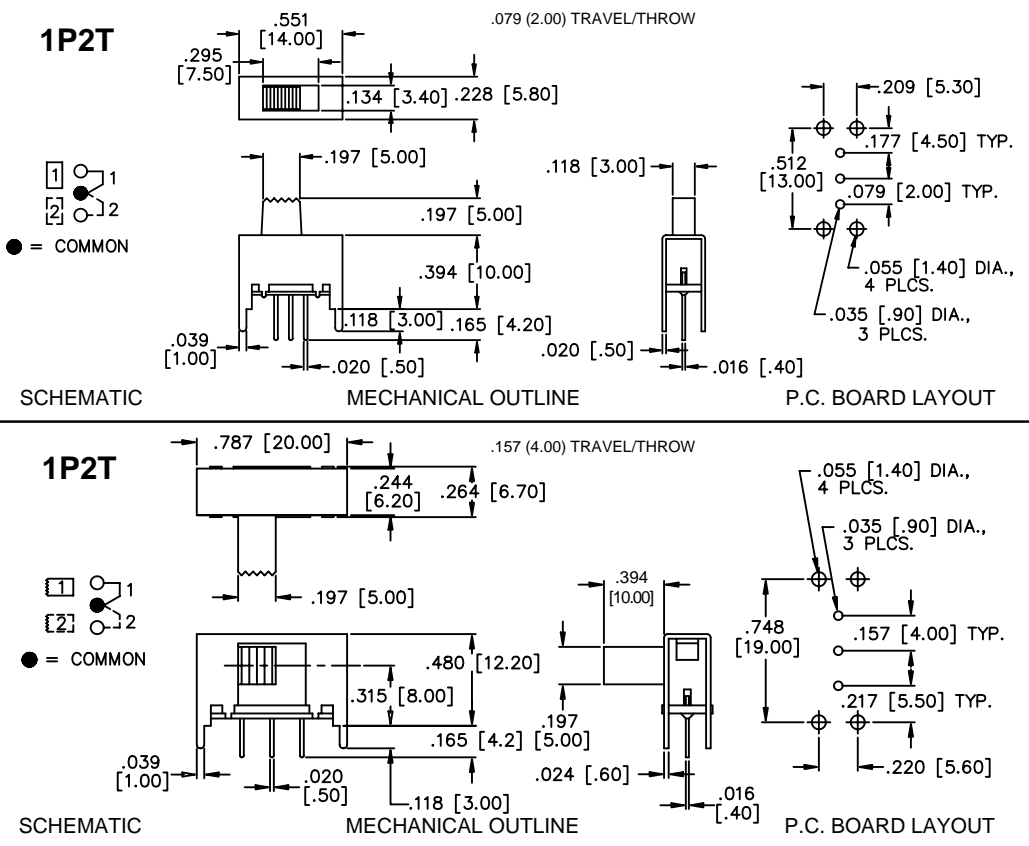



SPECIFICATIONS SUBJECT TO CHANGE WITHOUT NOTICE

MSS Series



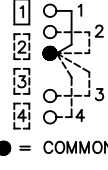
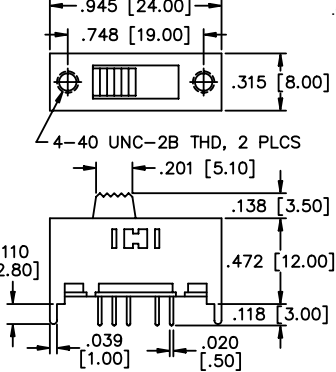
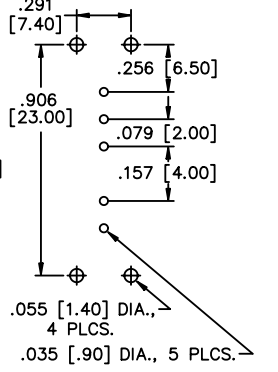

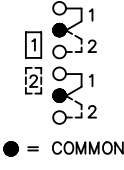
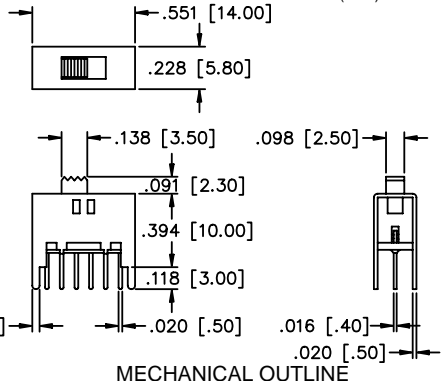
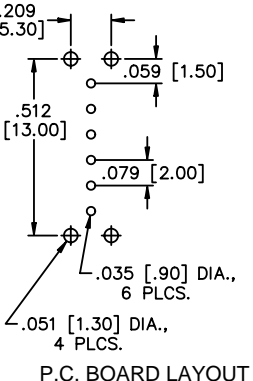
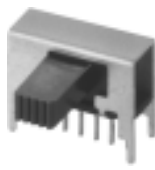
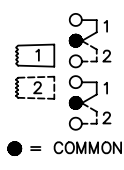
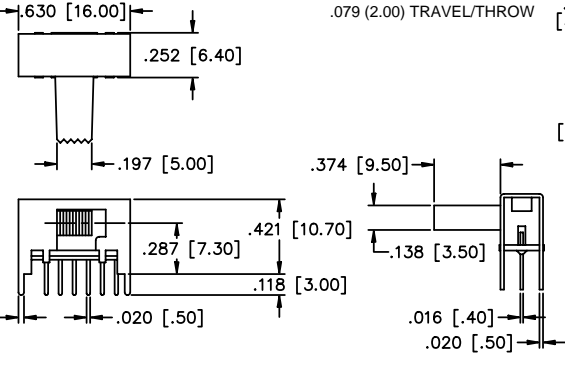
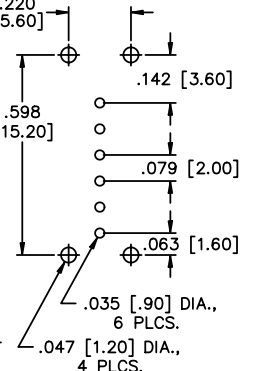
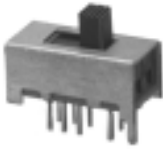
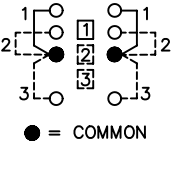
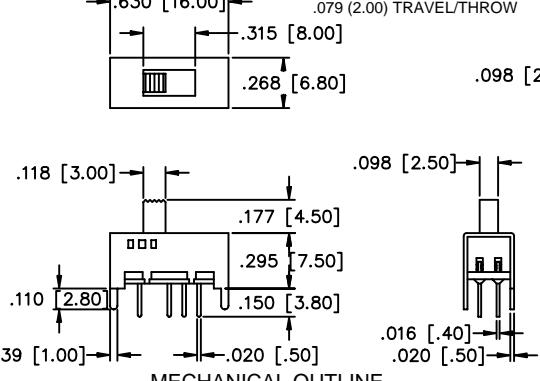
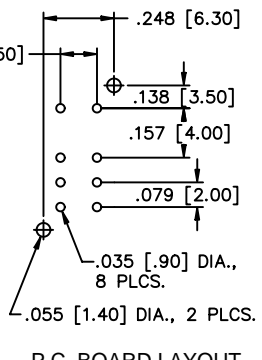

Standard Size Slide Switches

SPECIFICATIONS SUBJECT TO CHANGE WITHOUT NOTICE

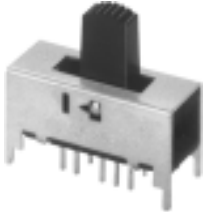
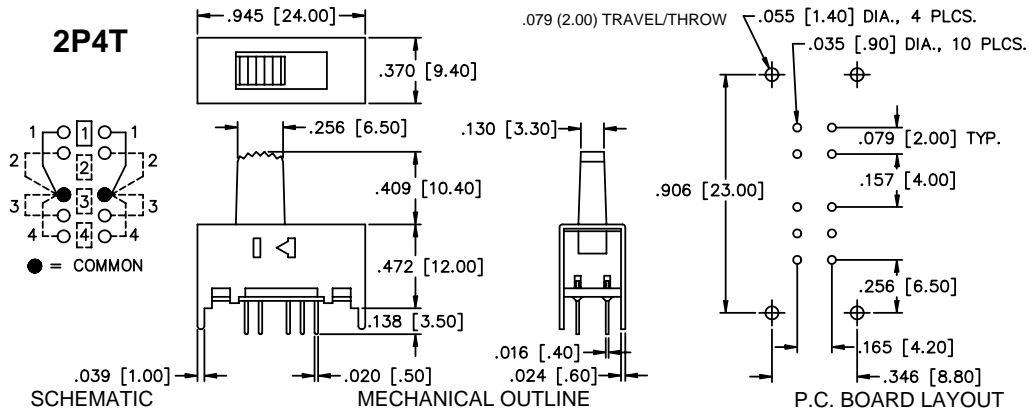
MODEL NO.	PLATING	
MSS14	SILVER	1P4T
	VERTICAL ACTUATOR	  
MSS22	SILVER	2P2T
MSS22G	GOLD	
	VERTICAL ACTUATOR	  
MSS225R	SILVER	2P2T
MSS225RG	GOLD	
	RIGHT ANGLE ACTUATOR	  
MSS23	SILVER	2P3T
	VERTICAL ACTUATOR	  

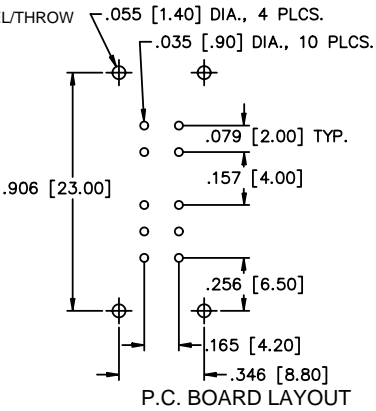
MSS Series

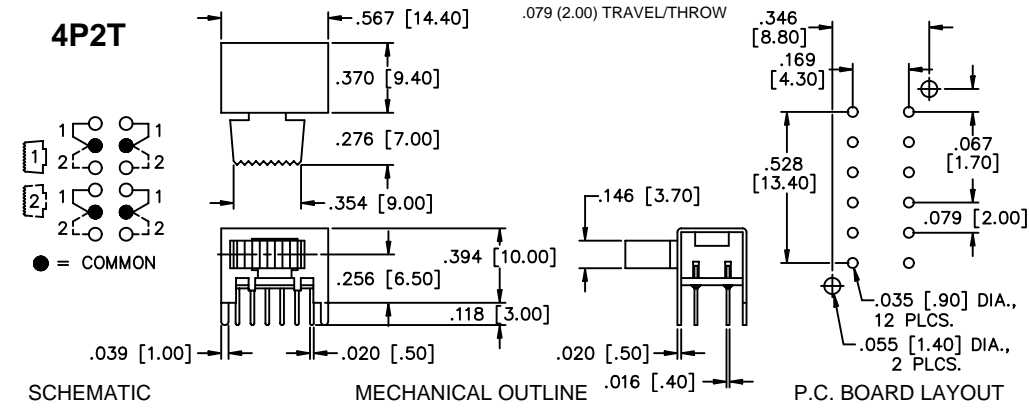
Standard Size Slide Switches

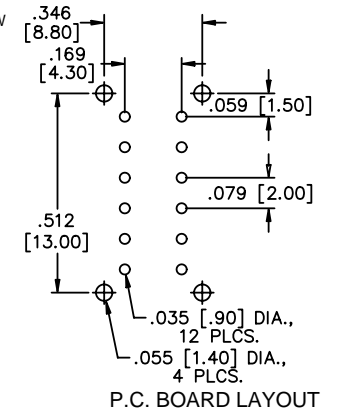
MODEL NO.	PLATING	
MSS24AG	GOLD	
		
VERTICAL ACTUATOR		
		<p>2P4T</p>  <p>SCHMATIC MECHANICAL OUTLINE P.C. BOARD LAYOUT</p>
MSS42	SILVER	
MSS42G	GOLD	
		
VERTICAL ACTUATOR		
		<p>4P2T</p>  <p>SCHMATIC MECHANICAL OUTLINE P.C. BOARD LAYOUT</p>
MSS42R	SILVER	
MSS42RG	GOLD	
		
RIGHT ANGLE ACTUATOR		
		<p>4P2T</p>  <p>SCHMATIC MECHANICAL OUTLINE P.C. BOARD LAYOUT</p>
MSS43	SILVER	
		
VERTICAL ACTUATOR		
		<p>4P3T</p>  <p>SCHMATIC MECHANICAL OUTLINE P.C. BOARD LAYOUT</p>

SPECIFICATIONS SUBJECT TO CHANGE WITHOUT NOTICE