

## Low Noise and High Dynamic Range Packaged GaAs FETs

### FEATURES

- 0.5 dB Typical Noise Figure at 12 GHz
- High Associated Gain:  $G_a = 11.5$  dB Typical at 12 GHz
- 18.5 dBm Typical Power at 12 GHz
- 12.5 dB Typical Linear Power Gain at 12 GHz
- Breakdown Voltage :  $BV_{DGO} \geq 9V$
- $L_g = 0.25 \mu m$ ,  $W_g = 160 \mu m$
- Tight  $V_p$  ranges control
- High RF input power handling capability
- 100 % DC Tested
- Leadless Air Cavity Plastic Package

### PHOTO ENLARGEMENT

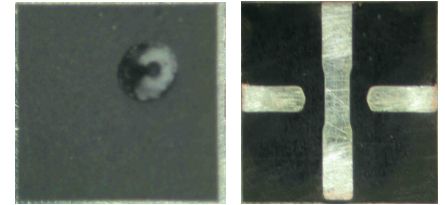

### DESCRIPTION

The TC2141 is a high performance field effect transistor housed in a leadless air cavity plastic package with TC1101 PHEMT Chip. It has very low noise figure, high associated gain and high dynamic range that makes this device suitable for use in low noise amplifiers. All devices are 100 % DC tested to assure consistent quality.

### ELECTRICAL SPECIFICATIONS ( $T_A = 25^\circ C$ )

Symbol	CONDITIONS	MIN	TYP	MAX	UNIT
NF	Noise Figure at $V_{DS} = 2 V$ , $I_{DS} = 10 mA$ , $f = 12GHz$		0.5	0.7	dB
$G_a$	Associated Gain at $V_{DS} = 2 V$ , $I_{DS} = 10 mA$ , $f = 12GHz$	10	11.5		dB
$P_{1dB}$	Output Power at 1dB Gain Compression Point, $f = 12 GHz$ $V_{DS} = 6 V$ , $I_{DS} = 25 mA$	17.5	18.5		dBm
$G_L$	Linear Power Gain, $f = 12GHz$ $V_{DS} = 6 V$ , $I_{DS} = 25 mA$	11	12.5		dB
$I_{DSS}$	Saturated Drain-Source Current at $V_{DS} = 2 V$ , $V_{GS} = 0 V$		48		mA
$g_m$	Transconductance at $V_{DS} = 2 V$ , $V_{GS} = 0 V$		55		mS
$V_p$	Pinch-off Voltage at $V_{DS} = 2 V$ , $I_D = 0.32mA$		-1.0*		Volts
$BV_{DGO}$	Drain-Gate Breakdown Voltage at $I_{DGO} = 0.08mA$	9	12		Volts
$R_{th}$	Thermal Resistance		250		$^\circ C/W$

### ABSOLUTE MAXIMUM RATINGS ( $T_A = 25^\circ C$ )

Symbol	Parameter	Rating
$V_{DS}$	Drain-Source Voltage	7.0 V
$V_{GS}$	Gate-Source Voltage	-3.0 V
$I_{DS}$	Drain Current	$I_{DSS}$
$I_{GS}$	Gate Current	160 $\mu A$
$P_{in}$	RF Input Power, CW	18 dBm
$P_T$	Continuous Dissipation	150 mW
$T_{CH}$	Channel Temperature	175 $^\circ C$
$T_{STG}$	Storage Temperature	- 65 $^\circ C$ to +175 $^\circ C$

### TYPICAL NOISE PARAMETERS ( $T_A = 25^\circ C$ )

$V_{DS} = 2 V$ ,  $I_{DS} = 10 mA$

Frequency (GHz)	$NF_{opt}$ (dB)	$G_A$ (dB)	$\Gamma_{opt}$		Rn/50
			MAG	ANG	
2	0.35	18.4	0.98	18	0.42
4	0.37	16.8	0.84	35	0.36
6	0.39	15.2	0.67	56	0.28
8	0.42	13.7	0.50	82	0.21
10	0.48	12.3	0.35	115	0.13
12	0.54	11.3	0.25	157	0.10
14	0.63	10.8	0.22	206	0.09
16	0.79	10.6	0.27	266	0.12
18	0.97	10.2	0.46	336	0.25

\* For the tight control of the pinch-off voltage range, we divide TC2131 into 3 model numbers to fit customer design requirement

(1)TC2131P0710 :  $V_p = -0.7V$  to  $-1.0V$  (2)TC2131P0811 :  $V_p = -0.8V$  to  $-1.1V$  (3)TC2131P0912 :  $V_p = -0.9V$  to  $-1.2V$

If required, customer can specify the requirement in purchasing document. For special  $V_p$  requirement, please contact factory for details.

**TYPICAL SCATTERING PARAMETERS (T<sub>A</sub>=25 °C)**

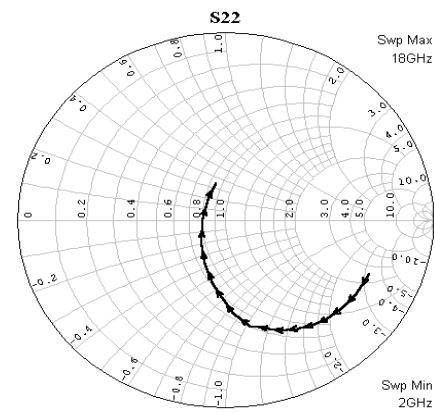
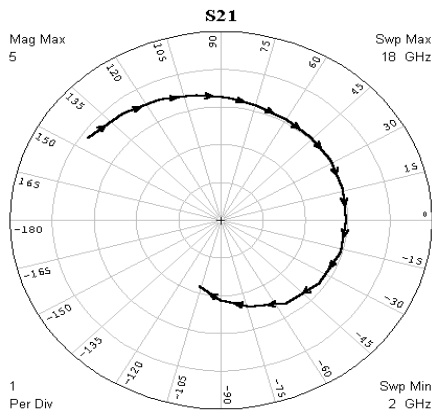
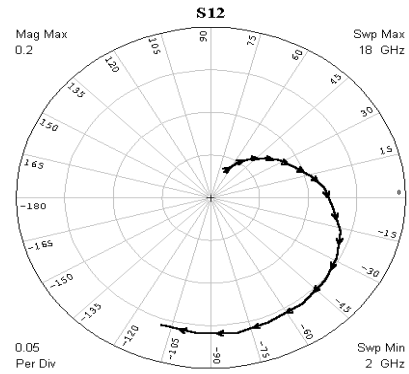
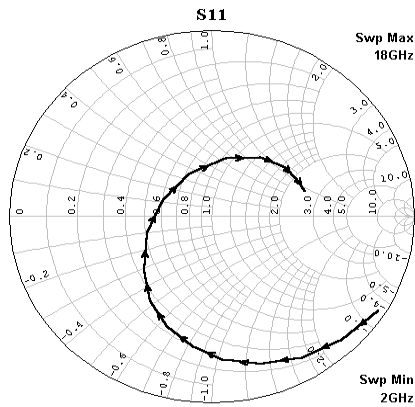
 V<sub>DS</sub> = 2 V, I<sub>DS</sub> = 10 mA

FREQUENCY (GHz)	S11		S21		S12		S22	
	MAG	ANG	MAG	ANG	MAG	ANG	MAG	ANG
2	0.965205	-31.683	3.82388	145.348	0.03317	65.4509	0.747438	-22.571
3	0.924858	-45.947	3.65307	129.745	0.04857	56.6606	0.742963	-32.124
4	0.880818	-59.301	3.51189	114.687	0.06181	47.9528	0.731908	-40.679
5	0.829029	-73.162	3.36103	99.8834	0.07323	38.9445	0.717426	-47.444
6	0.771102	-85.968	3.24504	86.4695	0.0845	30.7907	0.702251	-53.179
7	0.70583	-97.515	3.15691	73.3867	0.09456	21.6245	0.676201	-59
8	0.629927	-110.51	3.0841	59.1043	0.10693	13.3744	0.649454	-65.035
9	0.546078	-124.06	3.06542	45.9373	0.11755	5.8537	0.618383	-69.784
10	0.440135	-139.16	3.05823	31.4002	0.126	-5.2558	0.575837	-78.254
11	0.332891	-164.65	3.01447	15.7111	0.13976	-16.477	0.496185	-85.596
12	0.256372	159.256	2.98122	-0.2346	0.14777	-28.291	0.412967	-92.322
13	0.254107	115.507	2.97332	-16.627	0.15246	-39.539	0.341184	-100.16
14	0.321072	77.274	2.8578	-35.762	0.15664	-52.935	0.244764	-113.85
15	0.397158	52.89	2.69529	-54.381	0.1583	-67.907	0.164523	-134.02
16	0.449156	36.248	2.40145	-73.391	0.16114	-80.395	0.108944	177.113
17	0.467124	26.129	2.11816	-90.016	0.15982	-94.822	0.141475	125.593
18	0.481223	16.099	1.83195	-105.57	0.15787	-108.62	0.199877	103.4253

**TYPICAL SCATTERING PARAMETERS (T<sub>A</sub>=25 °C)**

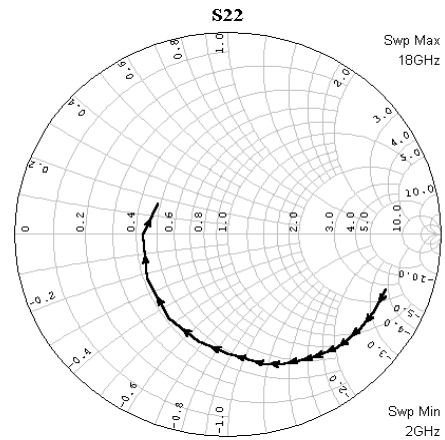
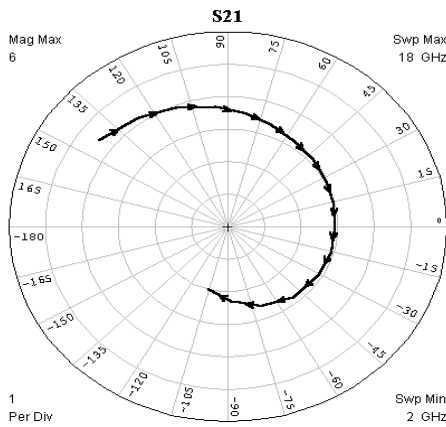
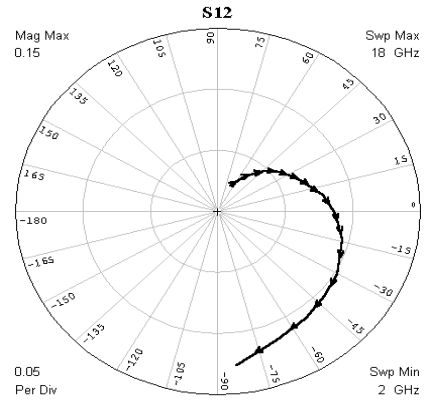
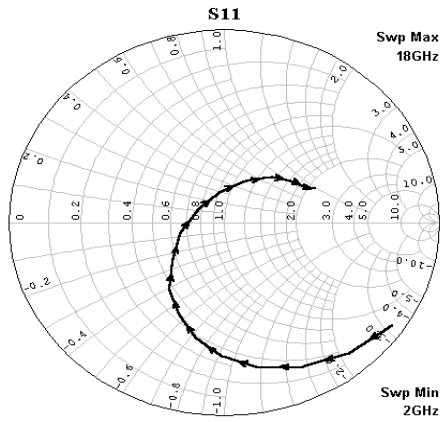
 V<sub>DS</sub> = 6 V, I<sub>DS</sub> = 25 mA

FREQUENCY (GHz)	S11		S21		S12		S22	
	MAG	ANG	MAG	ANG	MAG	ANG	MAG	ANG
2	0.944805	-34.153	4.40866	143.083	0.02291	66.477	0.791927	-20.49
3	0.892734	-49.529	4.15895	126.676	0.03306	56.3158	0.78719	-29.538
4	0.832754	-63.799	3.93284	110.775	0.04167	48.2699	0.778151	-37.49
5	0.765785	-78.089	3.70249	95.4448	0.05002	41.5562	0.767888	-43.661
6	0.693206	-91.077	3.5173	81.6727	0.05648	34.108	0.758304	-48.684
7	0.613522	-102.47	3.35676	68.4984	0.06249	26.8653	0.740556	-53.823
8	0.519797	-113.89	3.20332	54.8442	0.06766	21.4523	0.726417	-57.871
9	0.427886	-126.39	3.12884	42.0365	0.0733	14.3471	0.710416	-61.795
10	0.307587	-140.59	3.04209	27.7927	0.07924	9.5851	0.693185	-68.827
11	0.21305	-164.61	2.99282	13.8934	0.0873	-1.1316	0.660028	-75.426
12	0.138246	150.521	2.92638	-0.509	0.09135	-8.5198	0.62782	-80.882
13	0.16028	98.096	2.95009	-15.27	0.09546	-14.044	0.588684	-90.011
14	0.239067	64.382	2.89076	-31.567	0.10238	-30.162	0.547458	-104.11
15	0.323465	46.866	2.82756	-50.54	0.10556	-41.513	0.497591	-123.16
16	0.38778	33.541	2.61783	-69.52	0.10885	-53.293	0.435297	-149.84
17	0.422061	25.628	2.31147	-87.596	0.11422	-67.981	0.394724	180.629
18	0.458962	22.461	2.00195	-105.36	0.12687	-83.754	0.359877	155.336

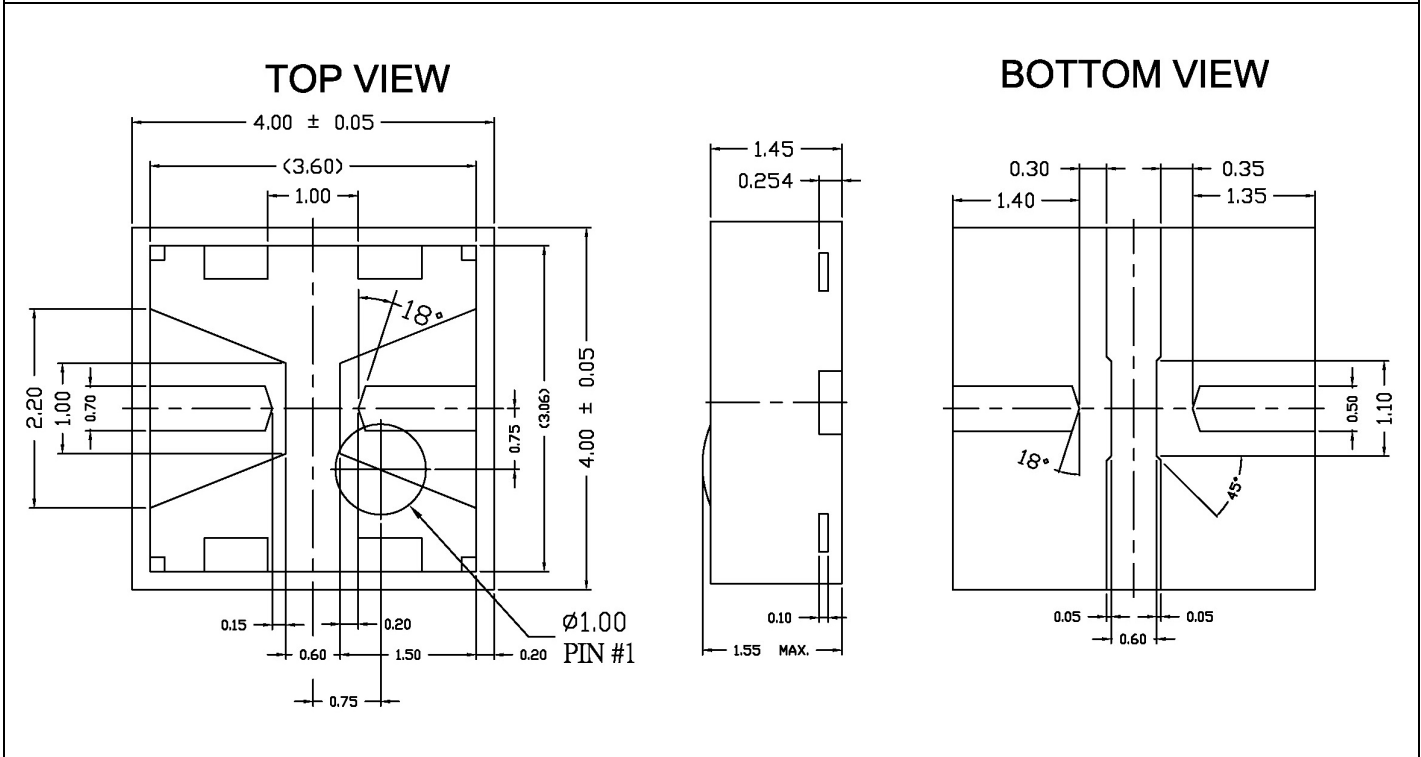
**OUTLINE DIMENSIONS (Unit: mm)**

**PIN LOCATION**
