



BAL-2690D3U

50 / 30+j25 balun transformer for 2.45 GHz ISM band

Features

- 50 Ω nominal input / 30+j25 output differential impedance
- Low insertion loss
- Low amplitude imbalance
- Low phase imbalance
- Small footprint: BAL-2690D3U < 1 mm²

Benefits

- Very low profile (<700 μ m)
- High RF performances
- RF BOM and area reduction

Applications

Balun transformer for applications such as:

- Bluetooth STLC2690
- Mobile phone

Description

The BAL-2690D3U is a balun designed to transform single ended signals to differential signals in Bluetooth applications.

The BAL-2690D3U has been customized for the STLC2690 Bluetooth transceiver with 0.8 dB insertion losses in the bandwidth (2400 MHz - 2500 MHz) and with a specific requirement for the S_{CC22} parameter.

The BAL-2690D3U has been designed using STMicroelectronics IPD (integrated passive device) technology on non conductive glass substrate to optimize RF performances.

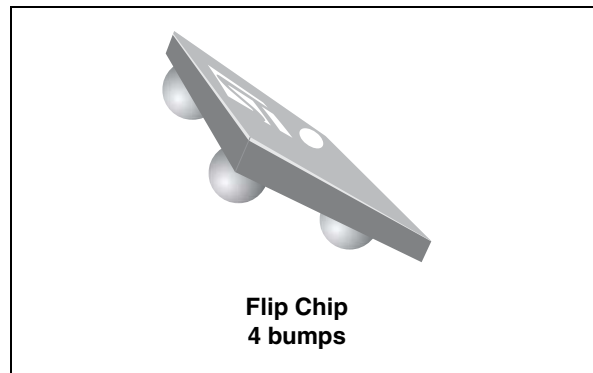

Figure 1. Top view

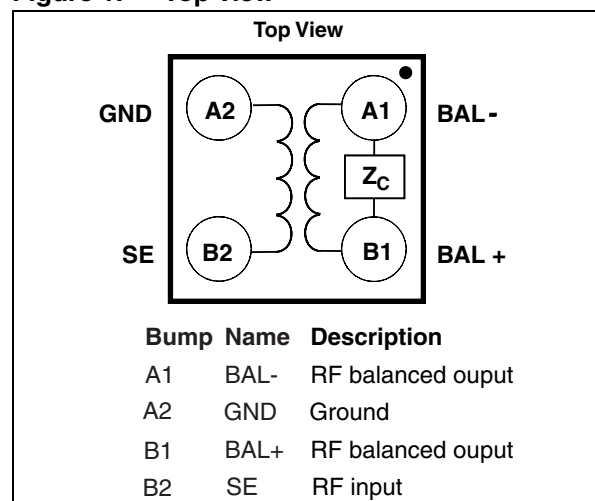
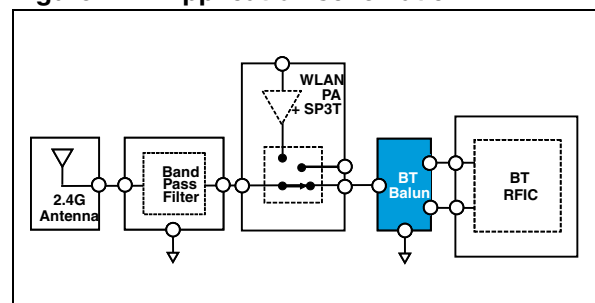

Figure 2. Application schematic



TM: IPAD is a trademark of STMicroelectronics.

1 Electrical characteristics

Table 1. Absolute maximum ratings (limiting values)

Symbol	Test condition	Min.	Typ.	Max.	Unit
P_{IN}	Input power R_{FIN}	-	-	20	dBm
V_{ESD}	ESD ratings MIL STD883C (HBM: C = 100 pF, R = 1.5k , air discharge)	2000			V
	ESD ratings, machine model (MM: C = 200 pF, R = 25 Ω L = 500 nH)	500	-	-	
	ESD ratings, charged device model (CDM) (JESD22-C101D)	500			
T_{OP}	Operating temperature	-40	-	+85	$^{\circ}C$

Table 2. Electrical characteristics ($T_{amb} = 25^{\circ}C$) impedances

Symbol	Test condition	Min.	Typ.	Max.	Unit
Z_{OUT}	Nominal differential output impedance	-	$30 + j25$	-	Ω
Z_{IN}	Nominal input impedance	-	50	-	Ω

Table 3. RF performance

Symbol	Test condition		Min.	Typ.	Max.	Unit
F	Frequency range (bandwidth)		2402	2441	2480	MHz
I_L	Insertion loss in bandwidth		-	0.8	1.1	dB
ripple	Ripple in bandwidth		-	-	0.6	dB
R_L	Return loss in bandwidth		14	-	-	dB
Φ_{imb}	Phase imbalance		-10	-	10	$^{\circ}$
A_{imb}	Amplitude imbalance		-1	-	1	dB
R_{CMRR}	Common mode rejection ratio (S_{SC12})		20	-	-	dB
S_{CC22}	Magnitude for common mode harmonic rejection coefficient @ $2f_O$	From 4804 MHz to 4960 MHz, 25 Ω is considered as reference for CM	0.7	-	1	$^{\circ}$
	Phase for common mode harmonic rejection coefficient @ $2f_O$		-45	-	0	

Figure 3. Insertion loss ($T_{amb}= 25\text{ }^{\circ}\text{C}$)

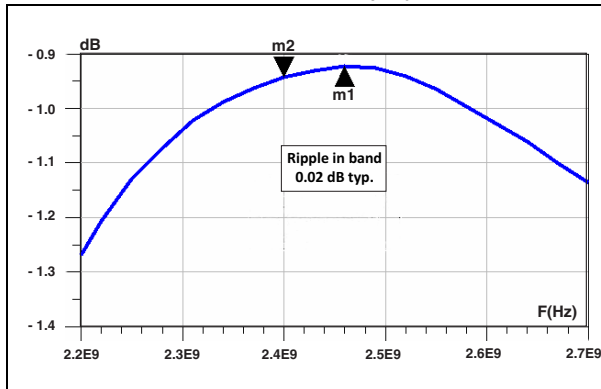

Figure 4. Return loss ($T_{amb}= 25\text{ }^{\circ}\text{C}$)

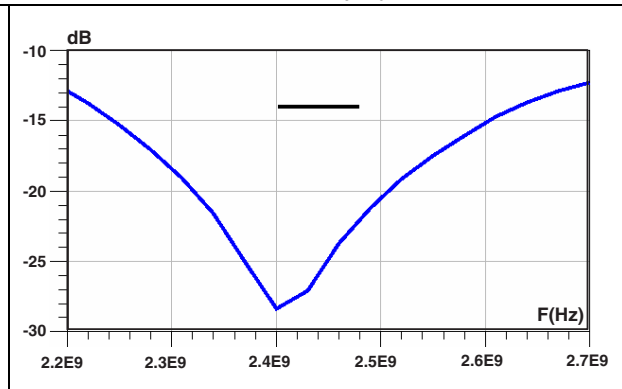

Figure 5. Amplitude imbalance ($T_{amb}= 25\text{ }^{\circ}\text{C}$)

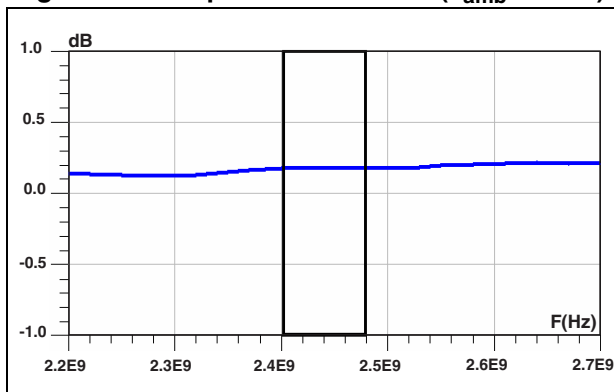

Figure 6. Phase imbalance ($T_{amb}= 25\text{ }^{\circ}\text{C}$)

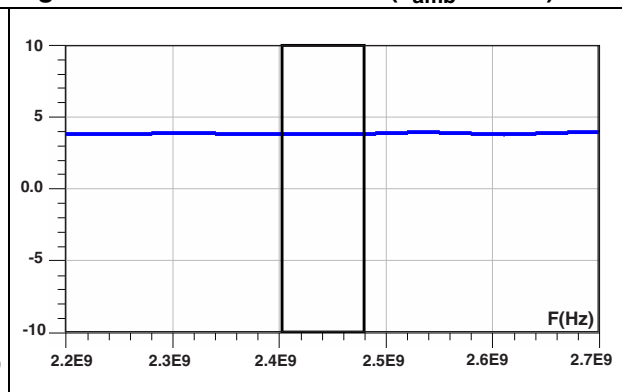

Figure 7. S_{cc22} magnitude @ $2f_0$ ($T_{amb} = 25\text{ }^{\circ}\text{C}$)

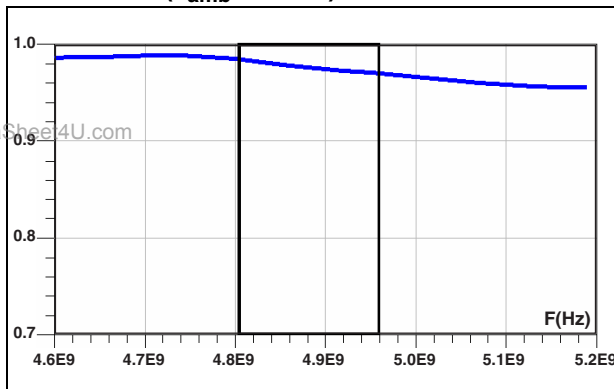
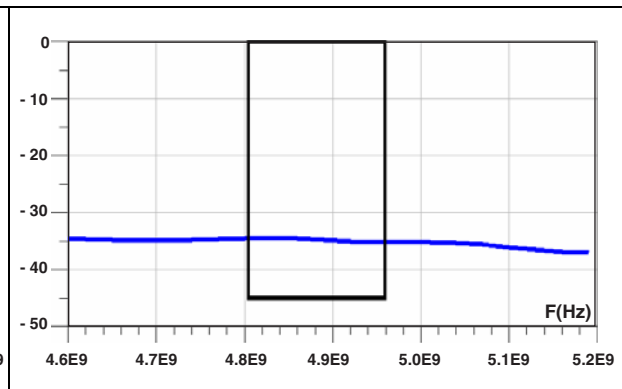

Figure 8. S_{cc22} phase @ $2f_0$ ($T_{amb} = 25\text{ }^{\circ}\text{C}$)



www.DataSheet4U.com

Figure 9. Recommend land pattern (used for balun characterization)

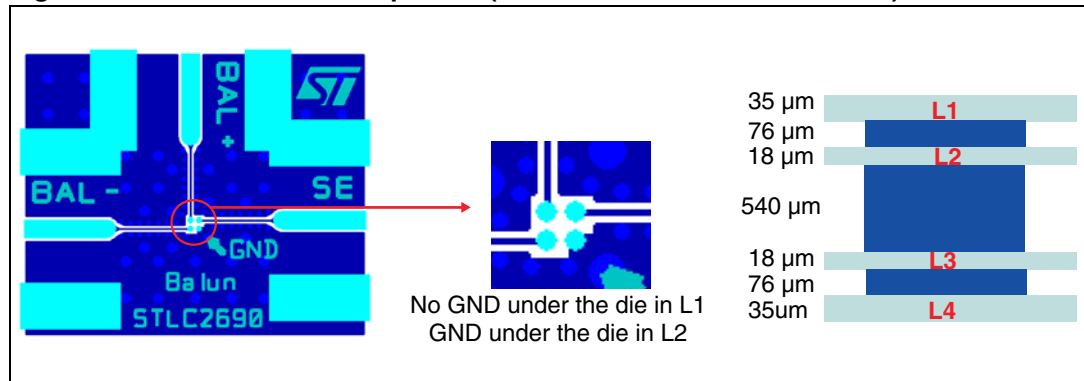
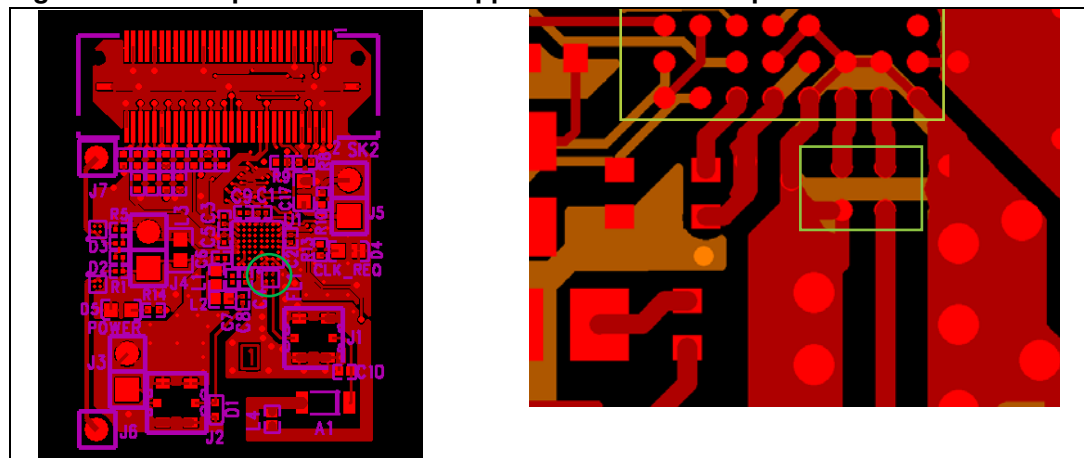

Figure 10. Example of transceiver application board land pattern



2 Package information

- Epoxy meets UL94, V0
- Lead-free package

In order to meet environmental requirements, ST offers these devices in different grades of ECOPACK[®] packages, depending on their level of environmental compliance. ECOPACK[®] specifications, grade definitions and product status are available at: www.st.com. ECOPACK[®] is an ST trademark.

Table 4. Package dimensions (values)

Ref.	Dimensions					
	Millimetres			Inches		
	Min.	Typ.	Max.	Min.	Typ.	Max.
A	0.565	0.63	0.695	0.022	0.025	0.027
A1	0.17	0.205	0.24	0.007	0.008	0.009
A2	-	0.4	-	-	0.016	-
b	0.215	0.255	0.295	0.008	0.010	0.012
D	0.86	0.91	0.96	0.034	0.036	0.038
D1	-	0.474	-	-	0.019	-
E	0.86	0.91	0.96	0.034	0.036	0.038
E1	-	0.474	-	-	0.019	-
SE	-	0.237	-	-	0.009	-
\$	-	0.025	-	-	0.001	-

Figure 11. Package dimensions (definitions)

www.DataSheet4U.com

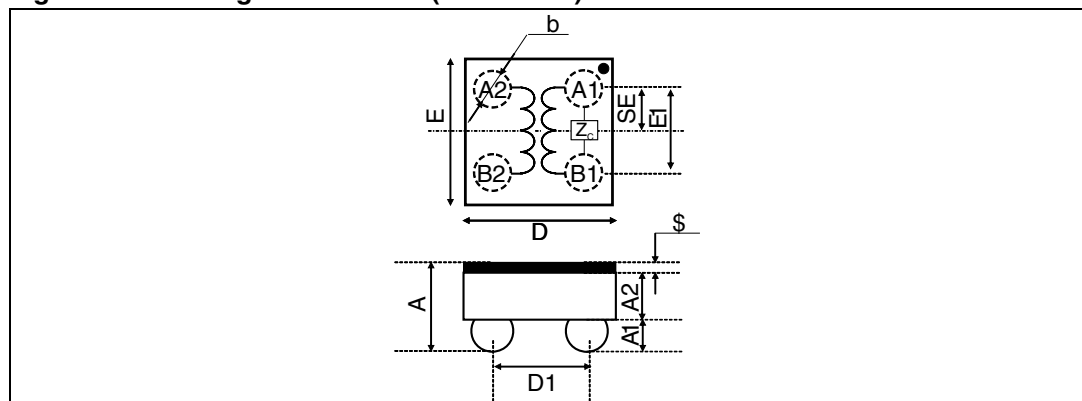

Package information

BAL-2690D3U

Figure 12. Footprint

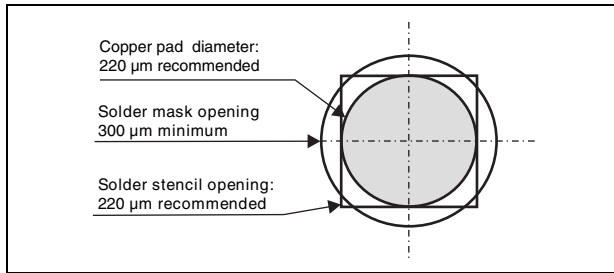

Figure 13. Marking

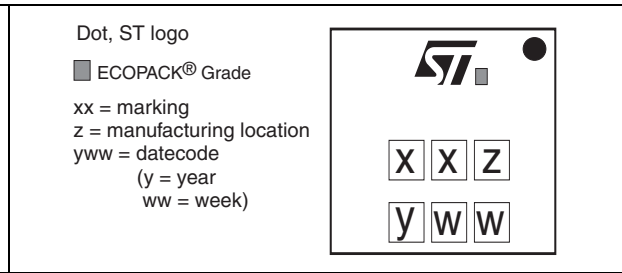
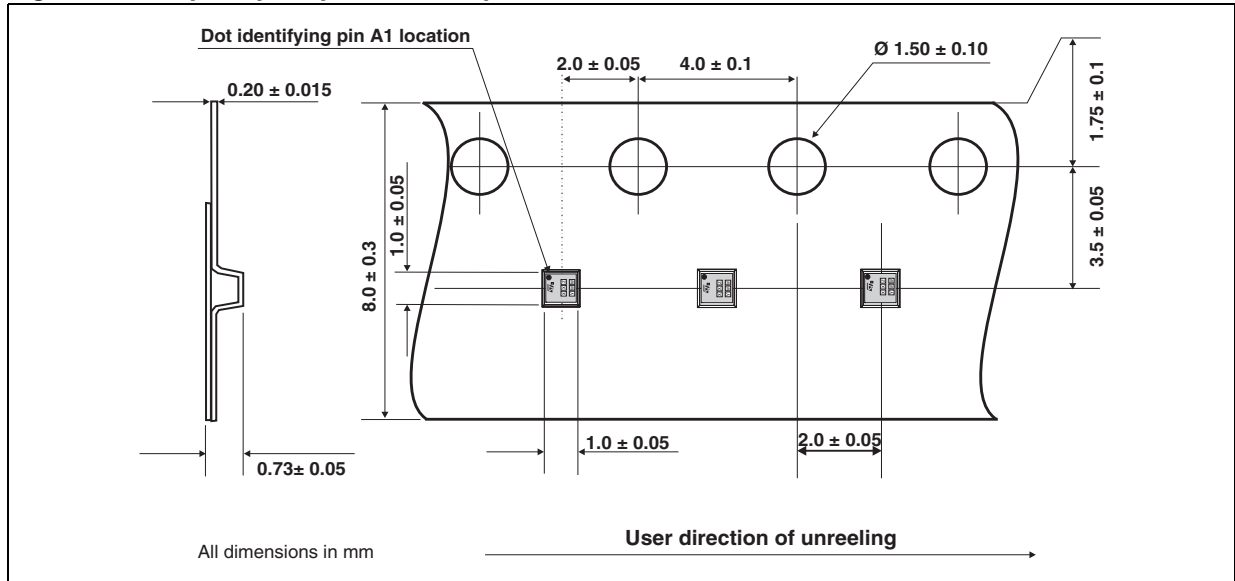

Figure 14. Flip Chip - tape and reel specification



Note: More packing information is available in the applications note:
AN 2348: "Flip Chip: package description and recommendations for use"

3 Ordering information

Table 5. Ordering information

Order code	Marking	Package	Weight	Base qty	Delivery mode
BAL-2690D3U	RP	Flip Chip	1.02 mg	5000	Tape and reel

4 Revision history

Table 6. Document revision history

Date	Revision	Changes
25-Jan-2010	1	First issue.

Please Read Carefully:

Information in this document is provided solely in connection with ST products. STMicroelectronics NV and its subsidiaries ("ST") reserve the right to make changes, corrections, modifications or improvements, to this document, and the products and services described herein at any time, without notice.

All ST products are sold pursuant to ST's terms and conditions of sale.

Purchasers are solely responsible for the choice, selection and use of the ST products and services described herein, and ST assumes no liability whatsoever relating to the choice, selection or use of the ST products and services described herein.

No license, express or implied, by estoppel or otherwise, to any intellectual property rights is granted under this document. If any part of this document refers to any third party products or services it shall not be deemed a license grant by ST for the use of such third party products or services, or any intellectual property contained therein or considered as a warranty covering the use in any manner whatsoever of such third party products or services or any intellectual property contained therein.

UNLESS OTHERWISE SET FORTH IN ST'S TERMS AND CONDITIONS OF SALE ST DISCLAIMS ANY EXPRESS OR IMPLIED WARRANTY WITH RESPECT TO THE USE AND/OR SALE OF ST PRODUCTS INCLUDING WITHOUT LIMITATION IMPLIED WARRANTIES OF MERCHANTABILITY, FITNESS FOR A PARTICULAR PURPOSE (AND THEIR EQUIVALENTS UNDER THE LAWS OF ANY JURISDICTION), OR INFRINGEMENT OF ANY PATENT, COPYRIGHT OR OTHER INTELLECTUAL PROPERTY RIGHT.

UNLESS EXPRESSLY APPROVED IN WRITING BY AN AUTHORIZED ST REPRESENTATIVE, ST PRODUCTS ARE NOT RECOMMENDED, AUTHORIZED OR WARRANTED FOR USE IN MILITARY, AIR CRAFT, SPACE, LIFE SAVING, OR LIFE SUSTAINING APPLICATIONS, NOR IN PRODUCTS OR SYSTEMS WHERE FAILURE OR MALFUNCTION MAY RESULT IN PERSONAL INJURY, DEATH, OR SEVERE PROPERTY OR ENVIRONMENTAL DAMAGE. ST PRODUCTS WHICH ARE NOT SPECIFIED AS "AUTOMOTIVE GRADE" MAY ONLY BE USED IN AUTOMOTIVE APPLICATIONS AT USER'S OWN RISK.

www.DataSheet4U.com

Resale of ST products with provisions different from the statements and/or technical features set forth in this document shall immediately void any warranty granted by ST for the ST product or service described herein and shall not create or extend in any manner whatsoever, any liability of ST.

ST and the ST logo are trademarks or registered trademarks of ST in various countries.

Information in this document supersedes and replaces all information previously supplied.

The ST logo is a registered trademark of STMicroelectronics. All other names are the property of their respective owners.

© 2010 STMicroelectronics - All rights reserved

STMicroelectronics group of companies

Australia - Belgium - Brazil - Canada - China - Czech Republic - Finland - France - Germany - Hong Kong - India - Israel - Italy - Japan - Malaysia - Malta - Morocco - Philippines - Singapore - Spain - Sweden - Switzerland - United Kingdom - United States of America

www.st.com