

SDA-5000 Series Stealth Digital Analyzer



Key Features

- Offers unmatched measurement performance for digital video, data, and traditional analog services in a single instrument
- Increases the efficiency of service calls and reduces troubleshooting time
- Ensures HFC network integrity with the JDSU non-interfering forward and reverse sweep system compatible with today's digital signals
- Enables easy preparation of networks for interactive services with a 5 to 1000-MHz, fast, sensitive spectrum analyzer
- Delivers comprehensive testing of forward and reverse digital services including optional QAM analysis
- Ensures full in-service proof-of-performance with automated tests
- Rugged, weather-resistant, and lightweight

In the world of high-growth subscriber services, engineers and technicians struggle with assignments as diverse as tracking down and fixing ingress, aligning optical nodes, and proof-of-performance. With competitive threats building, cable operators need easy and cost-effective solutions for efficient installation, qualification, maintenance and troubleshooting their HFC networks.

The JDSU SDA-5000 Series of Stealth Digital Analyzers provides a lightweight, weather resistant, rugged, and affordable single instrument with the versatility to test the latest digital services as well as the ideal device for maintaining the analog spectrum. The SDA Series provides seamless forward and return path testing as well as advanced digital testing. A host of invaluable extra options such as QAM analysis and PathTrak Field View are available, enabling the SDA Series to be customized for both the cable operator's network technology level and budget.

The SDA builds on JDSU's market leading RF sweep capabilities with numerous new features that ensure engineers can cope with the changing demands of today's network.

Backward compatibility with earlier JDSU Stealth and StealthTrak Series products build on a company's existing investment. Automated testing, new "Find and Fix" tools, and easy-to-use graphical user interfaces ensure training time is kept to a minimum. In addition, users familiar with a JDSU Stealth product can transfer their existing expertise to other SDA products without additional training.

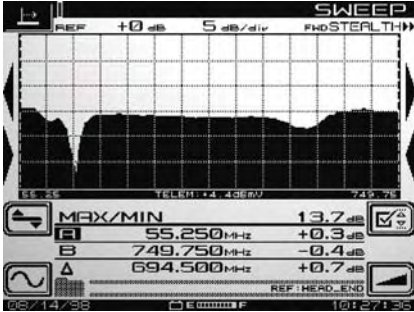

Forward and reverse non-interfering Sweep enables easy preparation of networks for interactive services

Offers single-instrument testing of all services

JDSU SDA Series testers are capable of handling a broad spectrum of interactive testing needs including reverse sweep, multiple-user reverse testing, portable reverse testing, reverse path noise testing, quality forward path digital services with QAM View and in-service cable modem analysis. The SDA-5000 Series of Stealth Digital Analyzers includes the SDA-5000, SDA-5500, and SDA-5510, each of which provides a single-instrument “One Box” solution for engineers and technicians. The main features include:

Analog testing

- Non-interfering forward RF sweep
- RF level, fast scan, tilt
- In-service carrier-to-noise, hum, depth of modulation
- Fast spectrum display with CTB/CSO
- Automatic/24-hour testing (FCC and CENELEC compliant)

Return path testing

- Non-interfering reverse RF sweep
- PathTrak Field View option pinpoints return path noise
- Reverse Alignment mode prepares network for cable modem deployment
- Reverse noise feature shows accumulated noise/ingress seen at the headend
- Zero Span Spectrum mode
- DOCSIS/DAVIC compatible cable modem analysis

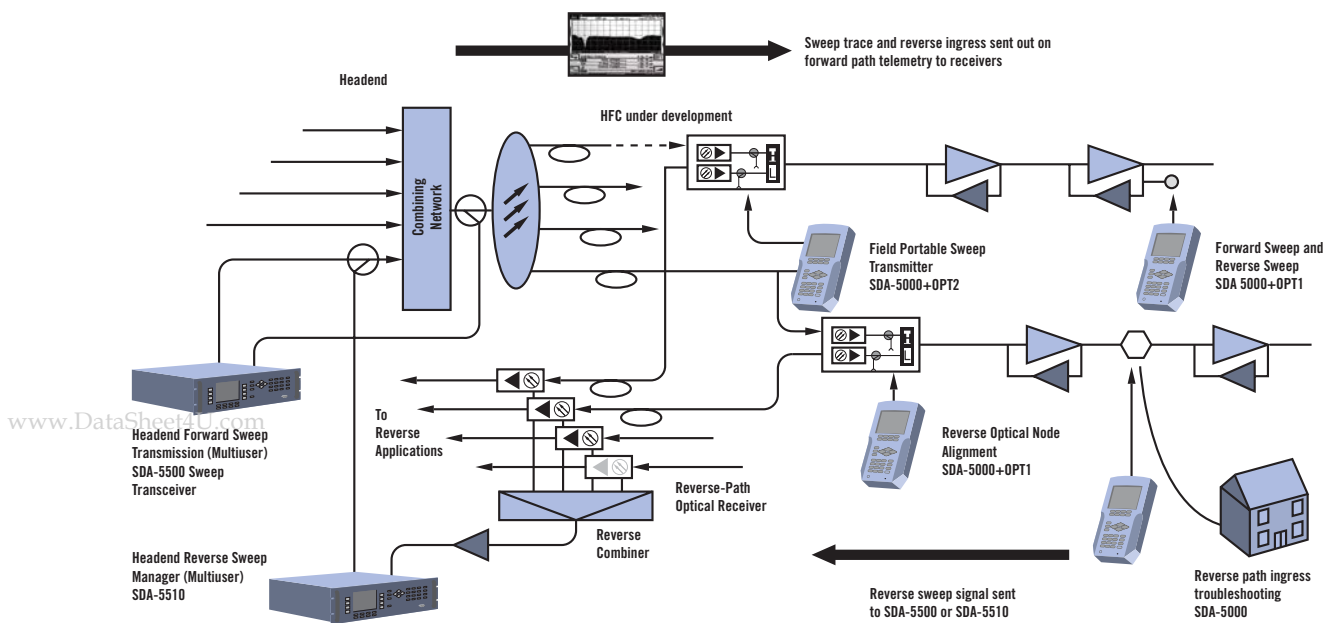

SDA instruments provide a comprehensive set of measurement tools that will follow the expansion of your cable network

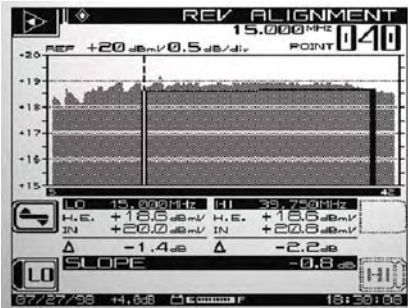

Reverse Alignment mode prepares network for cable modem deployment

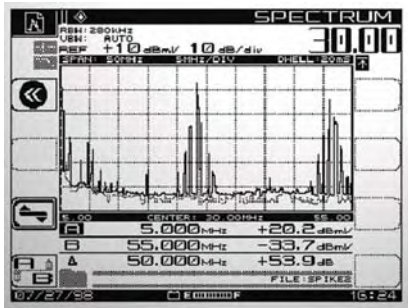

Reverse ingress spectrum display

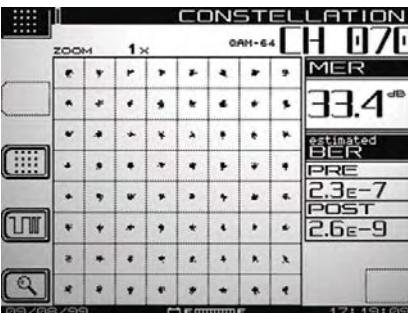

Constellation display with MER and pre/post FEC BER

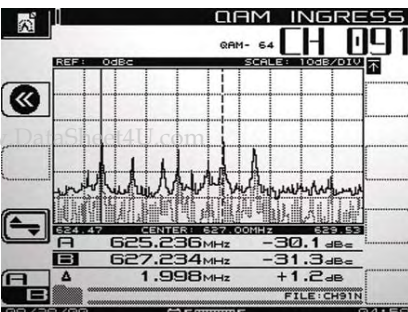

In-service ingress spectrum showing CTB/CSO-intermodulation problems due to analog-TV channels

Advanced digital testing

- JDSU digiCheck average power
- QAM View digital analysis with modulation error ratio (MER), pre/post FEC BER, constellation, and exclusive noise/ingress under the carrier measurement

Sweep is the right solution

The majority of all transmission errors (including digital) are found by measuring the frequency response of the network. Every physical error in the network that influences the transmitted signals will be revealed in the sweep trace. This means the sweep results are independent of transmission methods and formats.

When maintaining and setting up the HFC network, the goal is to transmit all signals with the best noise specifications and the lowest intermodulation distortion. Sweep provides the most effective and efficient tool to show the effects and compromises of setting up the correct gain versus frequency.

Normalized sweep

To ensure that network specifications are maintained, starting from the headend to the subscriber, each section of the network has its own set of specifications. A normalized sweep divides the network into easily managed sections. Each of these network sections can be designated to an individual team or contractor and tested to its own specifications and quality standards.

The SDA Series uses a variation of JDSU's original market-leading Stealth Sweep technology. Existing video carriers (analog, digital, or scrambled) are referenced when possible, eliminating any possibility of interference to the subscriber services. Where carriers are absent, the SDA-5500 transceiver at the headend transmits a sweep to fill vacant spectrum areas. To remove effects of headend level drift, the SDA-5500 transceiver monitors the levels and transmits new reference information with every sweep. This means that if the signal levels are changing in the headend, they will not affect the sweep response measurement. The SDA-5500 transceiver has all of the measurement capability of the SDA-5000 receiver enabling the technician to check headend levels.

The SDA Series also offers significantly faster forward sweep speed than earlier instruments, especially in systems that include many digital signals. They can reference 64/256 QAM signal types, removing the need to worry about subscriber interference, or injecting sweep carriers in the guard bands.

Reverse sweep

The SDA-5000 (with option 1 installed) enables simple and practical testing of the reverse path frequency response, regardless of the frequency (5 to 1000 MHz). It has a built-in reverse sweep transmitter, which means externally generated carriers are not required. Furthermore, the SDA-5500 transmitter and field receivers have frequency agile telemetry, enabling them to communicate on both the forward and reverse paths.

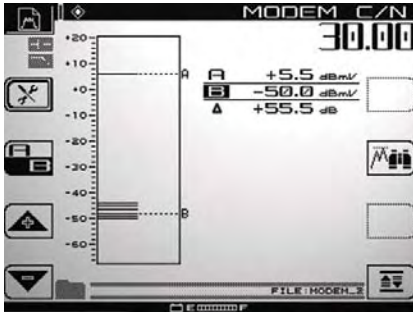

One button, in-service C/N measurements on TDMA return path cable modem signals (DOCSIS, EuroDOCSIS, EuroModem)

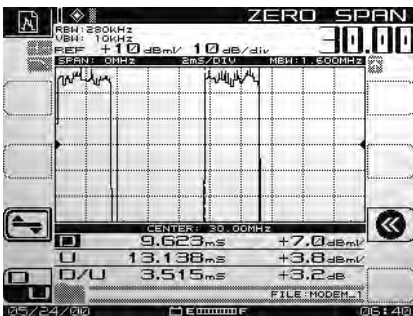

Zero span/time domain expert mode, showing the TDMA bursty return path cable modem power ramp of 3.5 ms

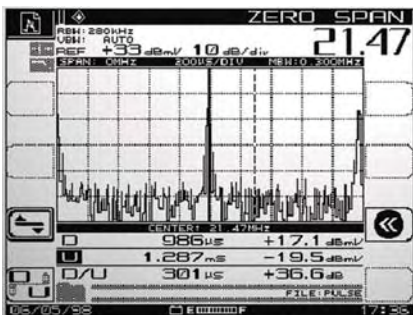

Time domain view of ingress in the Zero Span mode captures elusive ingress

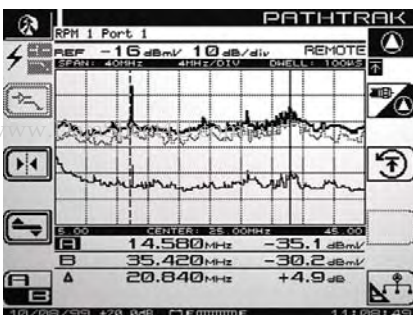

PathTrak Field View option compares headend node spectrum with field testpoint spectrum

SDA Series instruments enable one person to perform forward and reverse path alignment simultaneously. The operator simply indicates which screen should be displayed – either the response from the headend to the testpoint, or the response from the testpoint to the headend. A reverse sweep can uncover mismatch problems, which reveal themselves as standing waves, or diplex filter roll-offs that can severely hamper the quality of services in the reverse band.

Multiple-user reverse testing

For intense reverse testing requirements, the rack mounted model SDA-5510 Headend Reverse Sweep Manager handles the reverse sweep job for up to 10 different technicians on the same cluster of nodes. Using the SDA-5510 in conjunction with the model SDA-5500 transceiver provides a full forward and reverse sweep alignment solution. The SDA-5510 can also stand alone in remote hub sites for dedicated reverse alignment applications.

Seeing headend/hub site accumulated ingress in the field

The reverse noise feature of the SDA-5000 enables easy reverse path noise testing. The operator simply presses the “noise” softkey while reverse sweeping, and the display changes to a noise/ingress response indicating the noise level over the entire reverse path spectrum measured at the headend or hub site.

All SDA transmitters provide feedback to the field regarding the current condition of noise and ingress in the headend, even when noise or ingress is swamping the telemetry (Broadcast mode). A picture of the headend noise/ingress is sent out to the SDA receiver via a special forward telemetry carrier.

QAM View ensures quality forward path digital services

For measurement and analysis of digital TV and forward modem signals, the new digital QAM View option provides a full complement of digital quality measurements. Included is a 64/256 QAM constellation display with zoom, average digital power level, bit error rate (BER), 21 to 35-dB modulation error ratio (MER), and a noise margin “cliff effect” parameter. An equalizer display shows equalizer stress and distance to fault.

In addition, an exclusive Noise mode enables technicians to see ingress/noise under an active digital carrier. This tool is invaluable for detecting forward path ingress otherwise hidden by conventional spectrum views.

In-service cable modem analyzer

For bursty digital signals such as TDMA technologies used on cable modems for reverse services, the SDA-5000 offers two measurement choices. The first, a one-button cable modem analyzer test, shows carrier-to-noise measurements quickly. The second, an advanced zero span feature, uses a time domain display to allow power measurements while the modem is in service. Both modes are compatible with DOCSIS/EuroDOCSIS, CBR/switched circuit telephony, and proprietary cable modem standards.

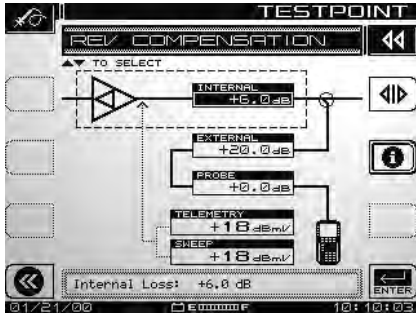

Graphical reverse testpoint compensation



The Navigator user interface, common on all JDSU SDA meters

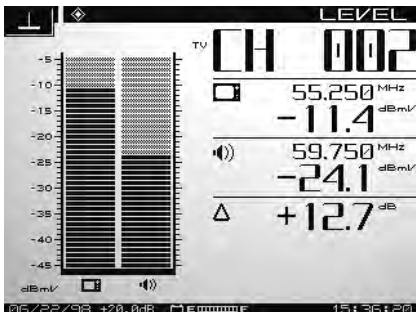

The single-channel level display shows both video and audio levels (either single or dual sound/ NICAM) and the difference between the two



Digital channel average power measurements can be made using the digiCheck™ feature

Detecting ingress in the field

When detecting ingress in the field, first the operator looks at the ingress present at the field testpoint using the spectrum display on any of the receivers and then switches to reverse ingress/noise to see the ingress at the headend for comparison. This time-saving procedure helps in locating sources of ingress. An adjustable dwell time ensures that even intermittent ingress is detected. The preamp and lowpass filter also assures that even low-level ingress is seen. The preamp and lowpass filter on the SDA-5000 assures that ingress can be measured on devices with bidirectional testpoints or testpoint values of 30 dB or more.

PathTrak Field View option

When a network is equipped with the JDSU PathTrak Performance Monitoring System, system technicians can benefit from the ultimate tool to combat ingress – the PathTrak Field View option for the SDA-5000. With Field View, the SDA-5000 receives a return path headend spectrum broadcast from the PathTrak unit and compares it with a return path spectrum at any field testpoint. The side-by-side spectrum comparison instantly reveals to the technician whether the ingress source is originating at the technician's current testpoint or at a different location. The comparative spectrum technique reduces noise/ingress troubleshooting time dramatically, since the technician can immediately verify whether corrective action performed in the field (local trace) results in improvement in the headend spectrum (remote trace).

Comprehensive testing

The SDA Series provides an extensive set of signal analysis features designed for proving and improving network quality. Its key capabilities include level measurement, analog and digital signal limits, tilt measurement, scan measurement, in-service carrier-to-noise measurement, hum measurement, modulation measurement, and local amplifier alignment with loopback tests.

Level measurement

The SDA instruments have a comprehensive single-channel level display with tuned channel, video frequency and level, audio frequency and level, and the difference between video and audio carrier levels.

Making accurate digital average power measurements is addressed with the digiCheck measurement function. The digiCheck feature is compatible with most non-bursty digital modulations in use today (that is, 16, 32, 64, 128, and 256 QAM, QPR, QPSK, VSB, and CAP16).

Analog and digital signal limits

Analog signal threshold limits have always been a technician's favorite feature of JDSU instruments. Automatic limit checks provide a quick go/no-go status for audio and video levels. The SDA Series extends this capability with a dedicated digital limit set that can be applied exclusively to the forward digital carriers defined in a channel plan. By assigning separate analog and digital limits, test time is reduced, since no calculation is necessary to determine if analog and digital level relationships are within system specifications. Analog and digital limit capability is available in both the Scan and Autotest modes.

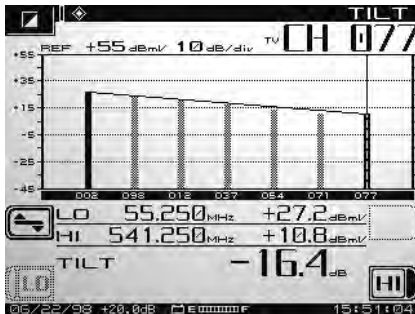

Tilt mode performs automatic tilt calculations between any two of nine designated carriers

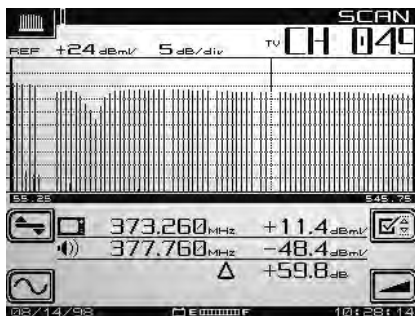

Limit checks can be instantly viewed after identifying channel of interest with a marker in Scan mode display

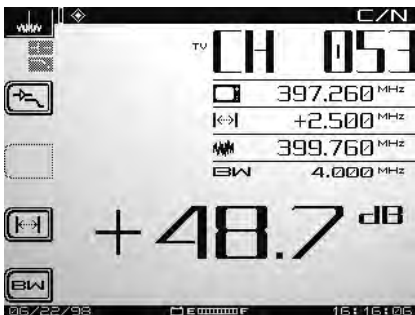

In-service carrier-to-noise

Tilt measurement

Tilt is the easiest and most efficient tool for balancing amplifiers. For cable plants requiring multiple tilt measurements, such as comparing today's tilt measurement with a historical record and then making an additional measurement for a new wider channel plan, the technician simply uses markers to indicate the tilt channels that define the new limits with the SDA Series.

Intermodulation distortion

Intermodulation distortion (CSO/CTB) can be automatically measured using the CTB/CSO mode from the spectrum analyzer. CTB/CSO distortions produced by intermodulation of analog TV carriers can degrade the signal quality of QAM modulated signals used by digital video and cable modems.

Scan measurement

The SDA Series Scan mode provides a quick graphical view of the entire channel plan with bars representing the video level for each channel. Both video and audio may be displayed.

Carrier-to-noise measurement: in-service

Carrier-to-noise measurements (on a non-scrambled channel) is just as easy with the SDA Series and there is no need to remove modulation from the video carrier. No tunable preselector filter is needed.

Hum measurement: in-service

Measuring hum on a channel (non-scrambled) is as simple as pressing the "HUM" key with the versatile JDSU SDA Series. Since the instrument is battery powered, the measurement is independent of ground loops and is, therefore, isolated from the line (mains). Hum is revealed as either single (60 Hz) or double (120 Hz) horizontal bars across the video screen.

Modulation measurement

SDA Series modulation measurements include NTSC, PAL, and SECAM formats. Demodulation of the audio is done for both AM and FM. FM is used to hear audio distortion on the FM radio channels or the sound of the TV program. AM is used to recognize short-wave interference signals in the reverse band.

Local amplifier alignment w/loopback tests

The SDA Series' loopback tests enable the technician to perform frequency response measurements of active or passive field devices. Either a CW or sweep signal may be generated from the SDA instrument and injected to the input of a device under test. The DUT output can then be measured by the SDA, providing valuable information such as gain, loss, roll-off, or frequency response. The CW loopback test is available on the SDA-5000 with option 1. The CW loopback and sweep loopback features are available on the SDA-5000 with option 2.



In-service "HUM" (PAL and NTSC compatible)

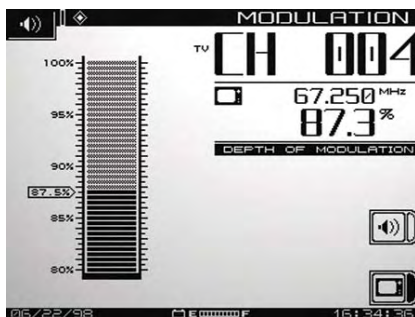

Depth of modulation

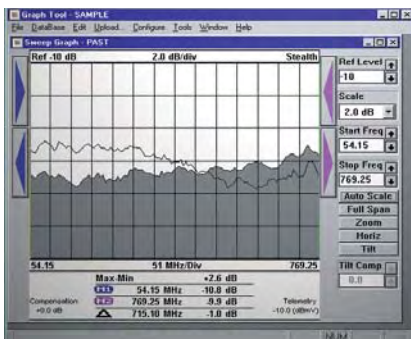

Detailed forward/ reverse sweep graph offers adjustable markers, scale, reference level and tilt. Users can clearly distinguish between previous and current sweep measurements for easy comparison on PC StealthWare display

Provides the right solution for varying network needs

The SDA Series includes three models with multiple extra options ensuring that all testing needs, from portable in-the-field hub testing to rack-mounted, headend or hub requirements are catered to. The three models are also designed to interoperate with earlier JDSU Stealth models.

Field usage is covered by the SDA-5000. The SDA-5000 can be tailored with various options to meet the most demanding forward and reverse sweep needs.

Headend/hub usage is covered by the SDA-5500 and SDA-5510. The SDA-5500 provides forward sweep and single-user reverse sweep while the SDA-5510 provide multi-user reverse sweep. Full forward and reverse sweep alignment can be achieved by using the SDA-5510 in conjunction with the model SDA-5500 transceiver. The SDA-5510 can also be used alone in remote hub sites for dedicated reverse alignment applications.

For networks that do not provide a practical location to install a rack mounted SDA-5510, (that is, systems where reverse traffic is received by an ATM/SONET/SDH network rather than returning to the headend) the SDA-5000 with option 6 provides all the functionality of the SDA-5510, (Note: forward sweep capability is not included with SDA-5000 with option 6).

Stealth Sweep compatibility

The SDA Series is completely sweep compatible with Stealth 3SR, 3ST, 3HRV, and StealthTrak SSA-1000 Series instruments. The only requirement is that Firmware version 9.3 is installed in Stealth instruments, and Firmware version 2.0 installed in StealthTrak SSA-1000 instruments. To take full advantage of the faster forward sweep capability, all headend and field instruments must be SDA Series.

Upgrading from Stealth to SDA

The JDSU upgrade program is designed to protect customers' investments in test equipment. Any model 3SR, 3ST, or 3HRV can be upgraded to the SDA Series at any of JDSU worldwide service centers, and customers who own a model SSA-1000 can upgrade to the SDA Series with an in-the-field Firmware change only.

Extensive automated test capability

The SDA Series offers a practical user interface, which normally only requires the push of a button to operate, and its built-in automation significantly reduces the cost of ownership to businesses.

Automated tests can be scheduled to perform either 24-hour FCC compliance tests, or initiated immediately to log performance at individual nodes, amplifiers, or other testpoints. A wide range of tests can be performed automatically, including signal levels, C/N, hum, and depth of modulation. The operator designates which tests to perform on which channels. Because these tests are non-intrusive, it is easy to test all parameters on all channels at any time.

After a test is performed, the results can be displayed on the SDA screen. A pass/fail indication on a variety of limits can be set for FCC/CENELEC or other government standards, or system preferences. Data taken during any automated test, or sequence of automated tests, can be viewed immediately with a pass/fail indication for each of the limits. Specific stored measurement results may be viewed on demand.

Data analysis with StealthWare

Test results can be printed directly to a serial printer or uploaded to a PC using JDSU StealthWare, a Microsoft® Windows®-based data management package, to store and include in custom reports. Stored sweep, scan, or spectrum screens can be viewed on the PC and analyzed with marker movement and readout information in just the same way as on the actual instrument. A sweep graph overlay function allows comparison of multiple RF response variations over time. Old sweep graphs may be downloaded back into the SDA instrument for realtime comparison.

Powerful and intuitive standardized graphical displays

All measurement results are presented to the user in clear, highly informative, summary displays. The graphics present the information the way the technician wants to see the results, with no further interpretation required. For example, testpoint compensation values are entered at the start of testing. Displays then calculate actual levels automatically, minimizing field errors.

Reduced training time

With SDA Series products, all levels of instruments are familiar to the technician, regardless of which is learned first, because the same user interface conventions are used across all product families. The time needed for a trainee technician to learn to use the instrument is considerably shorter than with alternative test equipment. This means urgent upgrade projects make the most efficient use of limited resources when SDA Series products are used.

JDSU Basic Service packages

To ensure the highest levels of support for SDA purchasers, JDSU offers the Basic Service for instrument package. Designed to provide the foundation for maximizing the features and usage of SDA equipment, JDSU's Basic Service package offers the following degrees of service and support only JDSU can provide. This includes:

- An extended warranty of up to five years
- Annual calibration – fully traceable to meet NIST standards

These core services provide the foundation for a longer product life, help you realize greater meter functionality and maximize your JDSU investment. Ask your sales representative or call the JDSU Customer Care Center for more information.

Technology training

JDSU provides a comprehensive Cable Networks technology training program designed to help you and your teams understand the changing needs of today's advanced networks.

Training seminars include:

- HFC basics
- Sweep and balance forward and return
- Sweep 101 “Bootcamp”

Application features

<i>Application</i>	<i>Feature</i>	<i>SDA-5000</i>	<i>SDA-5500</i>	<i>SDA-5510</i>
Full frequency response testing	Forward sweep mode using headend transmission	•	•	
Reverse path alignment for new digital services	Reverse Sweep mode	•		
Prepare for cable modem deployment	Reverse Alignment mode	•		
View return distortion and ingress as captured at headend	Reverse ingress/noise PathTrak Field View option	•	•	
Reverse path ingress troubleshooting	Built-in low-pass filter and preamp, dwell time	•		
Handle multiple reverse path sweep tests at one time	Multiple user reverse sweep reception (up to 10 simultaneous users)			•
Proactive reverse path maintenance capability	PathTrak Field View option	•		
Forward sweep without headend support	Sweepless Sweep using carrier levels only	•		
Forward path sweep carrier transmission	Forward transmission of sweep carriers	•	•	
Quick scan of active channel plan	SCAN mode w/limit check	•	•	•
View local distortion and ingress	Spectrum display	•	•	•
View and measure cable modem carriers on return path (DOCSIS/DAVIC)	Zero Span TDMA Time Domain mode	•	•	•
Test forward path digital services	digiCheck and QAM view option	•	•	•
CSO/CTB measurements	CSO/CTB mode	•	•	•
Amplifier checks and alignment	TILT mode	•	•	•
Local Amplifier and optical node alignment	CW Loopback (opt. 1 or 2) Sweep Loopback (opt. 2 only)	•		
In-service carrier-to-noise measurement	C/N mode	•	•	•
Analog and digital level measurements	LEVEL mode digiCheck mode	•	•	•
Depth of modulation measurements	MOD mode	•	•	•

Specifications

Start with any SAM-4040 or 4040D
Optional: PathTrak Field View (4040D)

A) Firmware
B) Hardware & firmware

Upgrade to SDA-4040D
Standard: DigiCheck, ZeroSpan, Dig Spectrum
Optional: PathTrak, Field View

Add Option 4 for QAM View

Any Stealth can upgrade to SDA-5000 for:
5 x faster sweep
256 QAM compatible sweep
Improved TP Comp setup for reverse sweep
A) Firmware
B) Hardware & firmware

SDA-5000 units can be purchased with, or upgraded to: QAM View, PathTrak Field View

Any 3ST can be upgraded to SDA-5000 for faster forward sweep and digital signal sweep compatibility

Any 3HRV can be upgraded to SDA-5510

Stealth to SDA series – product upgrade/replacement guide

Stealth model	SDA replacement
3SR	SDA-5000
3SR + 3SRV option	SDA-5000 with Option 1
3SR + 3SRT option	SDA-5000 with Option 2
3ST	SDA-5500
3HRV	SDA-5510
SSA-1000	SDA-5000 with Option 2 (firmware only)
SAM 4040	SDA-4040D
SAM-4040D	SDA-4040D (firmware only)

Frequency

Range	5 to 1000 MHz
Accuracy	±10 ppm at 25°C; ±10 ppm drift over temp ±3 ppm/year aging
Resolution bandwidths	30, 280 kHz and 2 MHz (30 kHz for CTB/CSO only)
Tuning resolution	10 kHz
Sweep resolution	250 kHz maximum

Level measurement

Range	-40 to +60 dBmV
Resolution	0.1 dB
Accuracy	±1.0 dB from -20 to +50°C ^(1,2)
Log linearity	±0.5 dB ⁽¹⁾
Flatness	±0.5 dB ⁽³⁾
Signal types	CW, single carrier, video (single or dual audio/NICAM), audio, digital
Uncertainty for digital carrier	additional ±0.5 dB (digital types 16/32/64/256 QAM, QPR, QPSK, VSB, CAP-16, DVB/ACTS and TDMA using Zero Span Spectrum mode) at 280 kHz RBW

Carrier-to-noise⁽⁴⁾

In-service measurement. Non-scrambled channels only. No preselection required for 78 channels or less. Best dynamic range at +10 dBmV or higher input.

Range	≥ 52 dB ⁽¹⁾
Resolution	< 0.5 dB

Hum measurement

In-service measurement. Carrier > 0 dBmV. Non-scrambled channels only.

Range	0 to 10%
Resolution	< 0.2%
Accuracy	±0.7%

Depth of modulation

Assumes presence of white reference on any VITS line. Non-scrambled channels only. Audio demodulation of AM and FM carriers.

Range	80 to 100%
Resolution	< 0.5% at 85%
Audio demodulation	AM and FM Carriers

Tilt measurement

Up to nine pilot carriers or video channels with tilt and level measurements on the highest and lowest.

Hi-lo Δ resolution	0.1 dB
--------------------	--------

Scan mode

All video, audio, pilot carrier, and digital channel levels displayed.

Sweep mode

(SDA-5000 and 5500 only)

Frequency range	5 to 1000 MHz
Display span	User definable
Display scale/range	6 vertical divisions 1, 2, 5, or 10 dB/division
Sweep pulse occupied bandwidth	30 kHz
Stability	±0.5 dB, normalized (dependent on stability of referenced carriers)
Sweep rate	~1 second (78 channels, including scrambled and digital signal types)

Channel plan templates (user editable)

China-1; China-2; France; HDTP-NL; Ireland;
Japan; Jerold; Jerold-HRC; Jerold-IRC;
NCTA; NCTA-HRC; NCTA-SUB; NCTA-IRC;
NTSC-Broadcast; OIRT-D/K; PL-B/G; PAL-UK

Spectrum mode

Spans	3, 5, 10, 20, and 50 MHz (0.3, 0.5, 1, 2, and 5 MHz/div)
Sweep rates	~1 second updates with spans of 50, 20, 10 and 5 MHz ~1.7 second updates with 3 MHz span
Display scaling and range	0.5, 1, 2, 5, and 10 dB/div 6 vertical divisions
Dwell	programmable 0-25 ms
Spurious free dynamic range	60 dB ₃
Sensitivity without preamp	-40 dBmV 5 to 550 MHz -35 dBmV 550 to 1000 MHz
Sensitivity with preamp	-50 dBmV 5 to 550 MHz -45 dBmV 550 to 1000 MHz
Maximum level with preamp	+50 dBmV

Zero Span mode

Video BW	> 1 MHz, 100 kHz, 10 kHz, 100 Hz
Resolution BW	2 MHz, 280 kHz, 30 kHz
Measurement BW	1 kHz to 99 MHz compensation programmable
Pulse measurement accuracy	nominal level in 10 μs ±2 dB from nominal in 5 μs (> 1 MHz VBW, 280 kHz RBW)
Sweep times	100 μs to 20 s (1, 2, 5 settings)

Intermodulation distortion (CSO/CTB)

Range ⁽⁵⁾	≥ 60 dB
Resolution	0.1 dB

Forward transmitter

(SDA-5000 with option 2/SDA-5500 only)

Frequency range	5 to 1000 MHz
Output level	+20 to +50 dBmV adjustable in 2 dB increments
Spectral purity	Hars -30 dBc; Spurs -35 dBc

Reverse transmitter

(Requires SDA-5000 with option 1 or 2)

Frequency range	5 to 1000 MHz
Output level	+20 to +50 dBmV, adjustable in 2 dB increments
Spectral purity	Hars -30 dBc; Spurs -35 dBc

Telemetry

Frequency range	5 to 1000 MHz
Modulation	FSK, 100 kHz deviation
Spectrum required	1.0 MHz vacant bandwidth recommended
Spectral purity	Hars -30 dBc; Spurs -35 dBc

Data storage

Files stored: auto tests, tilt, channel plans, scan and forward sweep. Also reverse sweep and reverse amp alignment on SDA-5000 with option 1 and/or 2. Spectrum mode (regular with max hold and CSO/CTB). Allocated on demand. The storage capability is simultaneous – more of one file type can be “traded” for less of another. All files stored as database, not as screen picture. (Example: typical mix of files for 78-channel plan: 8 channel plans, 16 sweep references, 80 sweep traces, 40 scan files, 20 spectrum displays and 20 auto tests).

Specifications

Serial interface

RS232; Epson, IBM, Seiko, and Diconix Printers

Input configuration

Connector type 75Ω type F female
(optional 75Ω type BNC female)

Maximum sustained voltage AC 100V DC 140V

General

Display 320 x 240 dot matrix LCD, selectable backlight
(SDA-5000 only)

Dimensions 6 x 11 x 3.5 in (15.2 x 27.9 x 8.9 cm)

Weight 5.1 lb (2.3 kg) (with option 1 or 2, 5.5 lb (2.5 kg))

Temperature range operating -20 to +47°C (-4 to 117°F)
(SDA-5500 and SDA-5510 only)

Dimensions 19 x 5.25 x 14 in (48.3 x 13.3 x 35.6 cm)

Weight 15 lb (6.8 kg)

Temperature range operating 0 to +50°C (32 to 120°F)

Power sources

Battery field extended-life replaceable,
nickel metal hydride 12V/3.5A-hr,
4 hours continuous use on a single charge

AC line (SDA-5000)

Charger input 100 to 250 VAC, 50 to 60 Hz, 0.5 A

Charger output aux out 16 V at 750 mA

Charge 15 V at 750 mA

AC line (SDA-5500) 100 to 265 to 63 Hz ~100 VAC
47 to 63 Hz ~100 VA

PathTrak Field View (opt 3 required)

(SDA-5000 and SDA-5500 only)

Update rate 2x/second (remote trace)
~1x/second (local trace)

Display scaling 5/1/2/5/10/20 dB/div.

Selectable nodes 14 (selectable via PathTrak HCU)

QAM View option (opt 4)

The QAM View option can be factory installed in any new or existing SDA Series instrument. The specifications and features are in addition to the standard measurement features of the SDA Series. When ordering, please specify option 4a for 8 MHz, DVB-C, ITU-T J.83 annex A, or option 4b for 6 MHz, DVS-031, ITU-T J.83 annex B.

Modulation type 64/256 QAM, DVB-C,
ITU-T J.83 annex A (option 4a)

64/256 QAM, DVS-031,

ITU-T J.83 annex B (option 4b)

Channel bandwidth 8 MHz (option 4A); 6 MHz (option 4B)

www.DataSheet4U.com

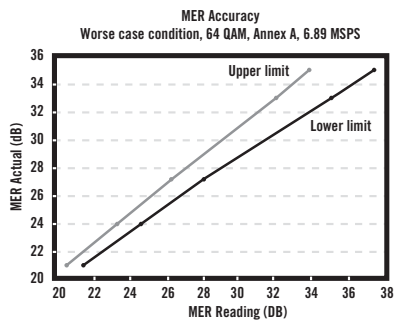

Measurable input range (lock range)

64 QAM -20 to +50 dBmV (typical)
256 QAM -15 to +50 dBmV (typical)

Frequency tuning

50 to 860 MHz (Digital QAM mode)

Resolution 50 kHz

BER (bit error rate)

64 QAM Pre-FEC/options 4A and 4B 10⁻⁴ to 10⁻⁹

64 QAM Post-FEC/options 4A and 4B 10⁻⁴ to 10⁻⁹

256 QAM Pre-FEC/options 4A and 4B 10⁻⁴ to 10⁻⁹

256 QAM Post-FEC/options 4A and 4B 10⁻⁴ to 10⁻⁹

MER (modulation error ratio)

64 QAM/option 4A 22 to 35 dB

Accuracy ±2.0 dB

64 QAM/option 4B 21 to 35 dB

Accuracy ±1.5 dB

256 QAM/option 4A 28 to 35 dB

Accuracy ±2.0 dB

256 QAM/option 4B 28 to 35 dB

Accuracy ±1.5 dB

EVM (error vector magnitude)

64 QAM/option 4A 1.2% to 5.2%

Accuracy ±0.5% (1.2% to 2.0%)

±1.0% (2.1% to 4.0%)

±1.4% (4.1% to 5.2%)

64 QAM/option 4B 1.2% to 5.8%

Accuracy ±0.5% (1.2% to 2.5%)

±1.1% (2.6% to 5.8%)

256 QAM/option 4A 1.1% to 2.5%

Accuracy ±0.6%

256 QAM/option 4B 1.1% to 2.5%

Accuracy ±0.5%

QAM level measurement

Signal types 64 QAM, 256 QAM

Range -20 to +45 dBmV

Accuracy ±1.0 dB

Flatness ±0.5 dB

Linearity ±1.0 dB

Temperature ±0.5 dB (typical)

Measurable QAM ingress

64 QAM -25 to -40 dBc

256 QAM -30 to -40 dBc

Accuracy ±3.0 dB

Graphic display

Digital summary (including MER/EVM, pre/post FEC BER, equalizer stress, carrier offset, symbol rate) with limit/margin test results, QAM level. IQ constellation with zoom. Adaptive equalizer display (in accordance with the DVB ERT 290 standard), frequency response, group delay. ingress/noise under the carrier.

Power source

Note: option powered from SDA Series nickel metal hydride battery. Operating time is specified for continuous use in QAM View mode. Option includes high-output charger.

Charge time ~4 hours

Operating time 2.5 hours continuous use (typical)

Universal AC charger/adaptor

Input 100-250 VAC, 50-60 Hz, 0.5 A

Output charge 15 V at 750 mA

Physical

(total SDA-5000 size with option 4)

Dimensions 6 x 10.5 x 4.25 in (15.2 x 26.7 x 10.8 cm)

Weight approx. 7.7 lb (3.5 kg)

Operating temperature range -4 to 113°F (-20 to 45°C)

Notes

(1) Typical specifications

(2) Relative to 25°C

(3) At 25°C and +20 dBmV

(4)

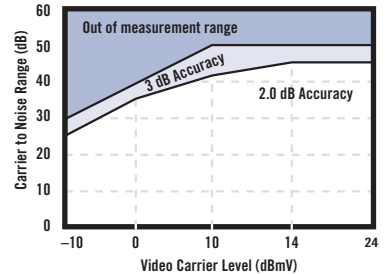

(5)

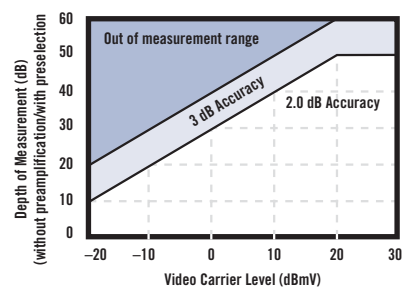

Specifications
Ordering information
Model SDA-5000
1010-00-0473

Forward and reverse sweep field receiver with advanced signal analysis. Compatible with older Stealth units running Firmware version 9.3. Includes: extended-life nickel metal hydride battery, universal charger/AC adapter, and operator's manual

Model SDA-5500
1010-00-0470

Headend sweep transceiver: Provides forward sweep and single user reverse sweep for SDA-5000. Compatible with older Stealth units running Firmware version 9.3. Includes: line cord, channel plan transfer cable, and operator's manual

Model SDA-5510
1010-00-0472

Headend reverse sweep manager: receives reverse sweep from up to 10 SDA-5000 receivers with options 1 or 2 installed. Compatible with older Stealth units running Firmware version 9.3. Includes: line cord, channel plan transfer cable, and operator's manual

Options
1019-00-1286

SDA-option 1: reverse sweep capability for model SDA-5000

1019-00-1285

SDA-option 2: reverse sweep capability and 5 to 1000 MHz transmitter for model SDA-5000

1019-00-1290

SDA-option 3a: PathTrak Field View interoperation for model SDA-5000 or SDA-5500 (PathTrak HCU)

1019-00-1287

SDA-option 4a: 64/256 QAM, DVB-C, ITU-T J.83 annex A. QAM View digital analysis including 64/256 constellation, MER, pre/post FEC BER, and exclusive QAM ingress under the carrier feature. Please specify option version 4a or 4b when ordering

1019-00-1288

SDA-option 4b: 64/256 QAM, DVS-031, ITU-T J.83 annex B. QAM View digital analysis including 64/256 constellation, MER, pre/post FEC BER, and exclusive QAM ingress under the carrier feature. Please specify option version 4a or 4b when ordering

1019-00-0460

SDA-option 5: BNC connectors replace standard F type connectors

1010-00-1295

SDA-option 6: portable reverse sweep Manager converts SDA-5000 to handheld version of the SDA-5510 (does not include forward sweep capability)

1013-00-0004

SDA-PACK1: SDA-5000 with Option 2 (reverse sweep) and Option 3a (PathTrak Field View) factory fitted

1010-00-0340

StealthWare: Windows-compatible data management software for all SDA, Stealth, MicroStealth, and CLI products

Optional accessories
1019-00-1298

SDA-CASE1: replacement soft carrying case for all SDA instruments without QAM View option installed. Compatible with standard and extended-life batteries

1019-00-1369

SDA-QAM CASE: replacement soft carrying case for all SDA instruments with QAM View Option installed

1019-00-1190

SDA-NIMH: spare extended-life battery

1019-00-1195

SDA-NIMCA: universal charger/AC adapter for extended-life nickel metal hydride battery

1012-00-0057

SDA-NIMK: extended-life battery kit. Includes extended-life battery, universal charger/AC adapter, and soft carrying case (SDA-CASE1) (For upgrading units without QAM View option)

1019-00-1329

CBC-2: In-vehicle charger for SDA NiMH extended life battery only utilizing standard 12V DC automotive accessory port

All statements, technical information and recommendations related to the products herein are based upon information believed to be reliable or accurate. However, the accuracy or completeness thereof is not guaranteed, and no responsibility is assumed for any inaccuracies. The user assumes all risks and liability whatsoever in connection with the use of a product or its application. JDSU reserves the right to change at any time without notice the design, specifications, function, fit or form of its products described herein, including withdrawal at any time of a product offered for sale herein. JDSU makes no representations that the products herein are free from any intellectual property claims of others. Please contact JDSU for more information. JDSU and the JDSU logo are trademarks of JDS Uniphase Corporation. Other trademarks are the property of their respective holders. ©2007 JDS Uniphase Corporation. All rights reserved. 30137231 501 0707 SDA5000.DS.CAB.TM.AE

Test & Measurement Regional Sales

NORTH AMERICA TEL: 1 866 228 3762 FAX: +1 301 353 9216	LATIN AMERICA TEL: +55 11 5503 3800 FAX: +55 11 5505 1598	ASIA PACIFIC TEL: +852 2892 0990 FAX: +852 2892 0770	EMEA TEL: +49 7121 86 2222 FAX: +49 7121 86 1222	www.jdsu.com/test www.DataSheet4U.com
---------------------------------------------------------------------	------------------------------------------------------------------------	-------------------------------------------------------------------	---------------------------------------------------------------	------------------------------------------------------------------------------------------------------------------------------