



Spec. No.	PS-DS-S39127B
Rev.	A

# PRODUCT SPECIFICATION

**Model No:CSDS-S39127B**

Descriptions:
<ul style="list-style-type: none"> <li>■ 0.39 Inch Single Digit SMD Display</li> <li>■ Common Cathode</li> <li>■ Emitting Color : Super Bright Blue</li> <li>■ Gray Face</li> <li>■ White Segment</li> </ul>



CUSTOMER APPROVED	APPROVED BY	CHECKED BY	PREPARED BY
SIGNATURES			

**CHINA SEMICONDUCTOR CORPORATION**  
Address:2FL. NO.909,Chung-Cheng Road,  
Chung-Ho City Taipei Hsien,Taiwan.

Tel:886-2-2223-9696  
Fax:886-2-2223-9377

**OPTO PLUS TECHNOLOGIES CO.,LTD**  
Address:696 Shun jiang Rd.,Shaoxing,  
ZheJiang,China

Tel:86-0575-88623888  
Fax:86-0575-88623112



**Model No: CSDS-S39127B**

**Features -**

1. 0.39 inch (10mm) digit height.
2. Qualified according to JEDEC moisture sensitivity Level 2a.
3. RoHS compliant.
4. Low power consumption.
5. Standard: gray face, white segment.
6. Easy mounting on P.C. board .

**Device Selection Guide -**

Model No.	Chip		Description
	Material	Emitting Color	
<b>CSDS-S39127B</b>	<b>InGaN</b>	<b>Super Bright Blue</b>	<b>Common Cathode</b>

**Mechanical Dimensions -**

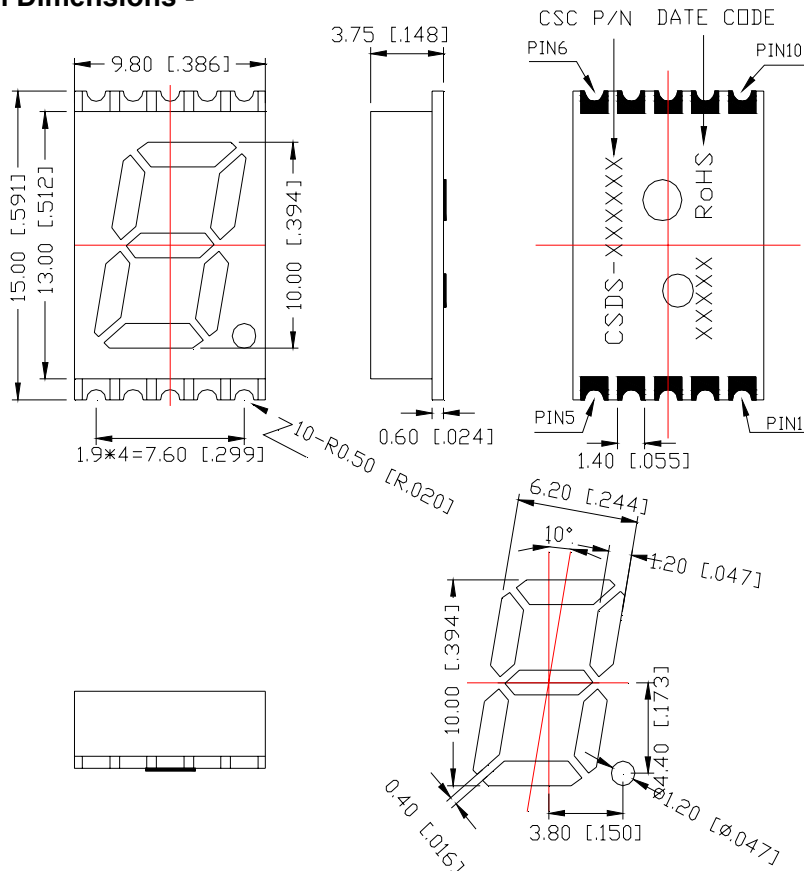

**Notes:**

1. Dimension in millimeter [inch], and tolerance is  $\pm 0.25$  [0.010] unless otherwise noted
2. Bending  $\leq$  Length\*1%.



Spec. No.	PS-DS-S39127B
Rev.	A

Model No: **CSDS-S39127B**

■ Internal Circuit Diagrams -

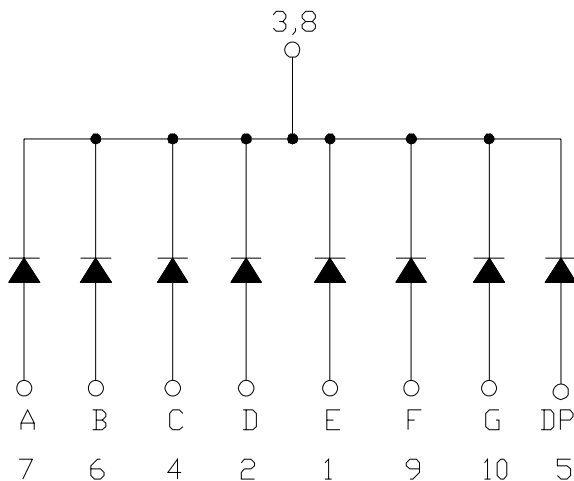
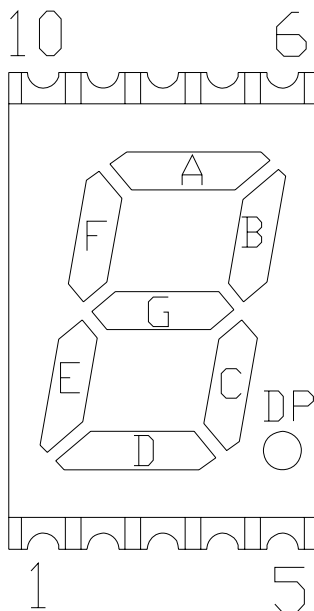



Model No: CSDS-S39127B

■ Absolute Maximum Rating -

(Ta=25°C)

Parameter	Symbol	Rating	Unit
Power Dissipation Per Dice	P <sub>AD</sub>	114	mW
Continuous Forward Current Per Dice	I <sub>AF</sub>	30	mA
Peak Current Per Dice(duty cycle 1/10,1KHz)	I <sub>PF</sub>	100	mA
Derating Linear From 25°C Per Dice	-	0.4	mA/°C
Reverse Voltage Per Dice	V <sub>R</sub>	5	V
Electrostatic Discharge(HBM)	ESD	1	KV
Operating Temp.	T <sub>opr</sub>	-40 ~ +105	°C
Storage Temp.	T <sub>stg</sub>	-40 ~ +105	°C

■ Electro-optical Characteristics -

(Ta=25°C)

Parameter	Symbol	Min.	Typ.	Max.	Unit	Condition
Forward Voltage Per Segment	V <sub>F</sub>	-	3.2	3.8	V	IF=20mA
Luminous Intensity Per Segment	I <sub>v</sub>	2.4	6	-	mcd	IF=10mA
Peak Emission Wavelength	λ <sub>P</sub>	-	468	-	nm	IF=20mA
Dominant Wavelength	λ <sub>d</sub>	-	470	-	nm	IF=20mA
Spectrum Radiation Bandwidth	Δλ	-	30	-	nm	IF=20mA
Reverse Current	I <sub>R</sub>	-	-	50	μA	V <sub>R</sub> =5V
Luminous Intensity Matching Ratio	I <sub>V-m</sub>	-	-	2:1	-	IF=10mA



Model No: **CSDS-S39127B**

### ■ Typical Electrical / Optical Characteristics Curves -

(Ta = 25°C Unless Otherwise Noted)

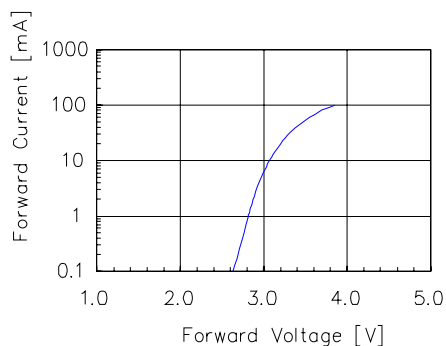

Fig 1. Forward Current vs. Forward Voltage

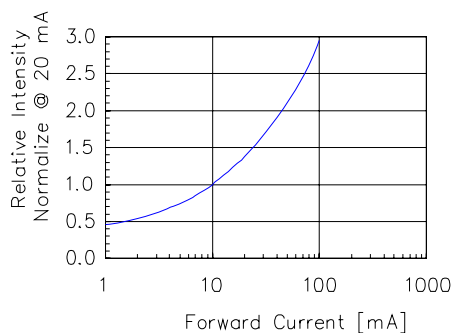

Fig 2. Relative Intensity vs. Forward Current

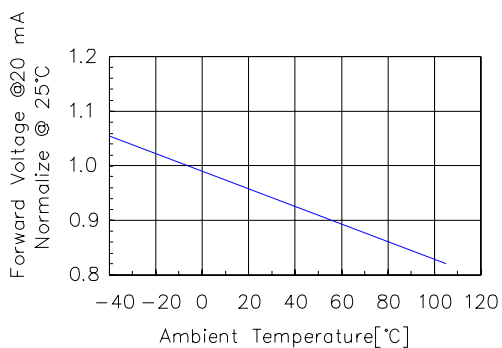

Fig 3. Forward Voltage vs. Temperature

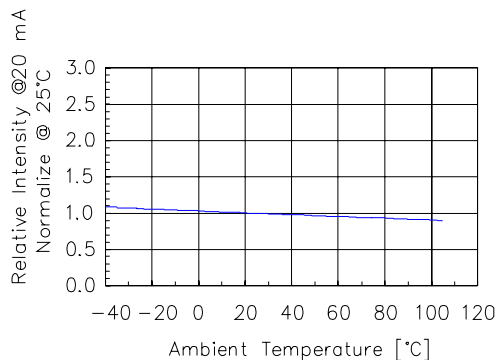

Fig 4. Relative Intensity vs. Temperature

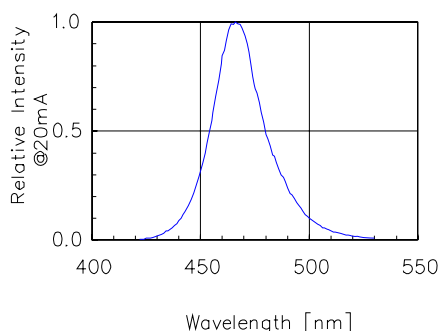

Fig 5. Relative Intensity vs. Wavelength



Model No: CSDS-S39127B

## SMT REFLOW SOLDERING INSTRUCTIONS

### IR Reflow Temperature / Time :

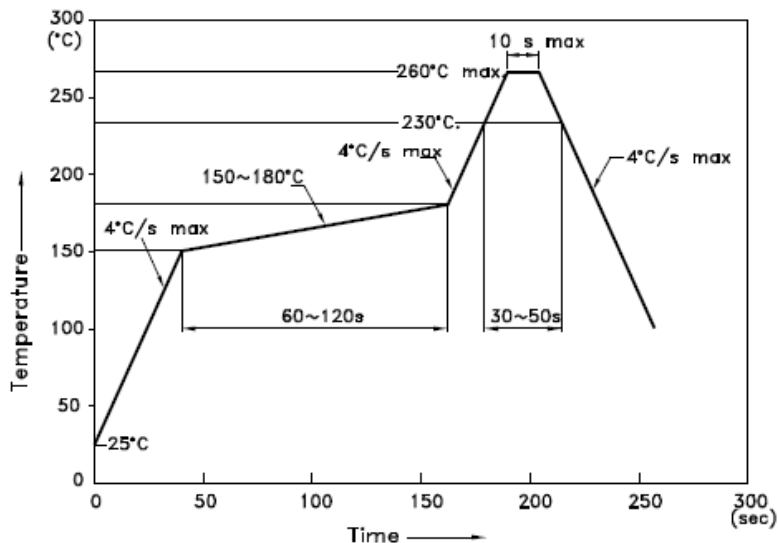

#### NOTES:

1. We recommend the reflow temperature 245°C(+/-5°C). The maximum soldering temperature should be limited to 260°C.
2. Don't cause stress to the epoxy resin while it is exposed to high temperature.
3. Number of reflow process shall be 2 times or less.

### Soldering Pad Size

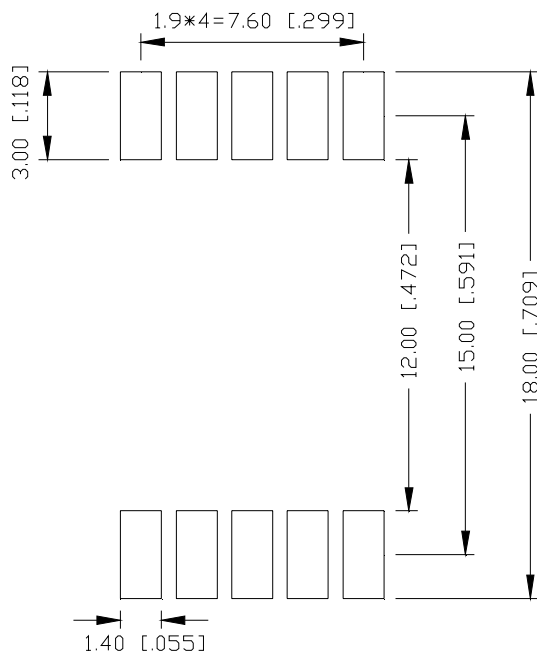



Spec. No.	PS-DS-S39127B
Rev.	A

Model No: CSDS-S39127B

### REEL DIMENSIONS

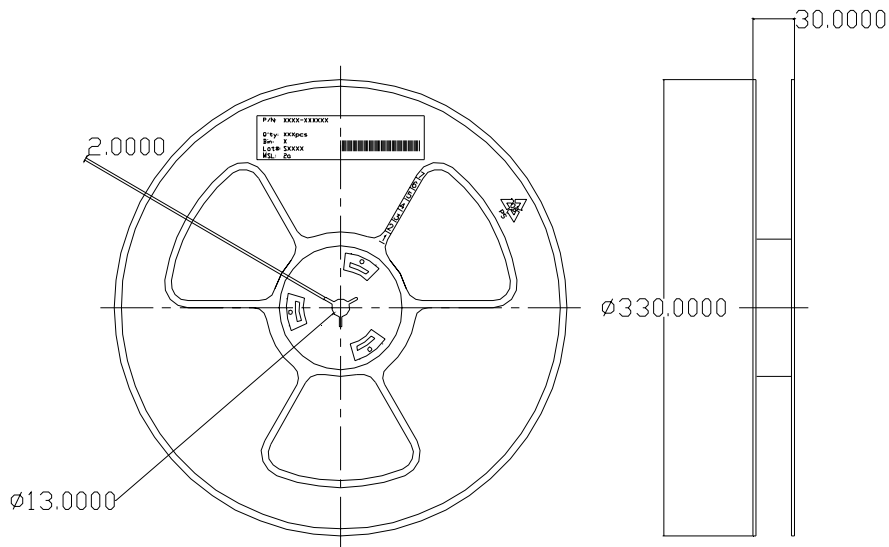

### PACKING & LABEL SPECIFICATIONS

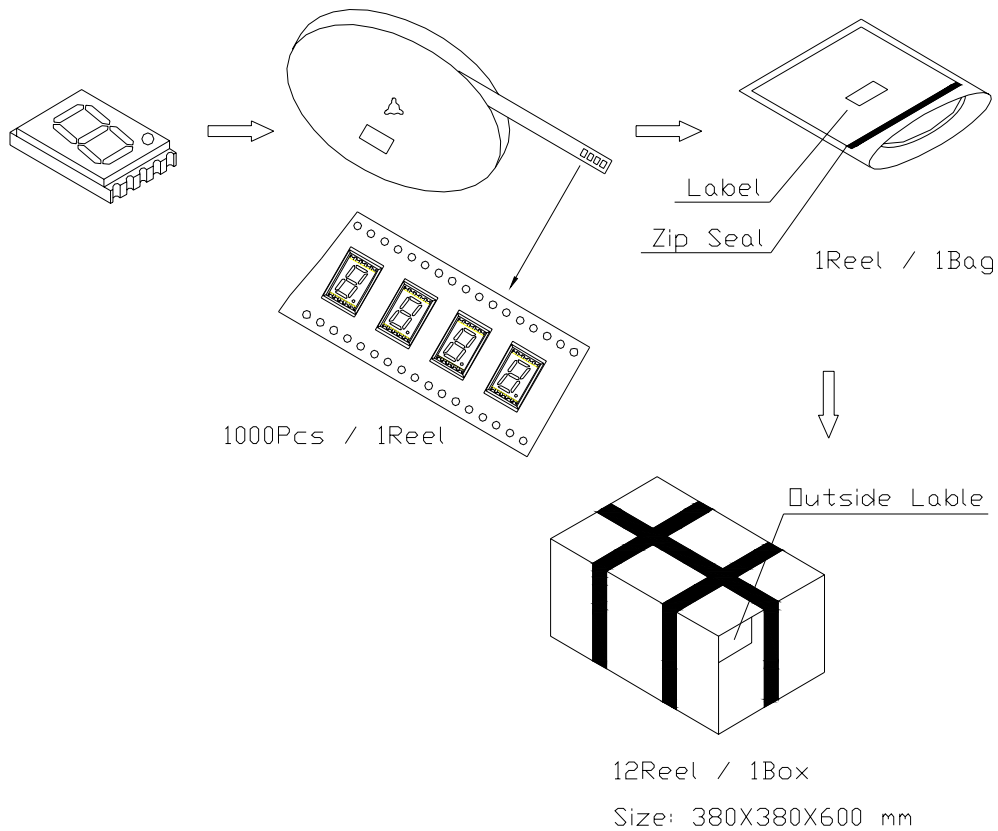

Note: The specifications are subject to change without notice. Please contact us for updated information