

4-channel BTL driver for CD players

BA6997FP / BA6997FM

The BA6997FP and BA6997FM, both designed for CD players, have an internal 4-channel BTL driver and 5V regulator (which requires attached PNP transistor), as well as switches for the 5V regulator and temperature monitor pins.

●Applications

CD players and other optical disc devices

●Features

- 1) 4-channel BTL driver for CD players.
- 2) Wide dynamic range.
- 3) Internal thermal shutdown circuit.
- 4) Internal level shift circuit, for a minimum of attached components.
- 5) Internal 5V regular with switch.

●Absolute maximum ratings (Ta = 25°C)

Parameter		Symbol	Limits	Unit
Power supply voltage		V _{cc}	18	V
Power dissipation	BA6997FP	P _d	1800*1 *2	mW
	BA6997FM		2200*1 *3	
Operating temperature		T _{opr}	-40~+85	°C
Storage temperature		T _{stg}	-55~+150	°C

*1 When mounted on a 70 × 70 × 1.6 mm glass epoxy board with less than 3% copper foil.

*2 Reduced by 14.4 mW for each increase in Ta of 1°C over 25°C.

*3 Reduced by 17.6 mW for each increase in Ta of 1°C over 25°C.

●Recommended operating conditions (Ta = 25°C)

Parameter	Symbol	Min.	Typ.	Max.	Unit
Power supply voltage	V _{cc}	4.5	—	12	V
	V _{cc} *4	6.0	—	12	

*4 With regulator

●Block diagram

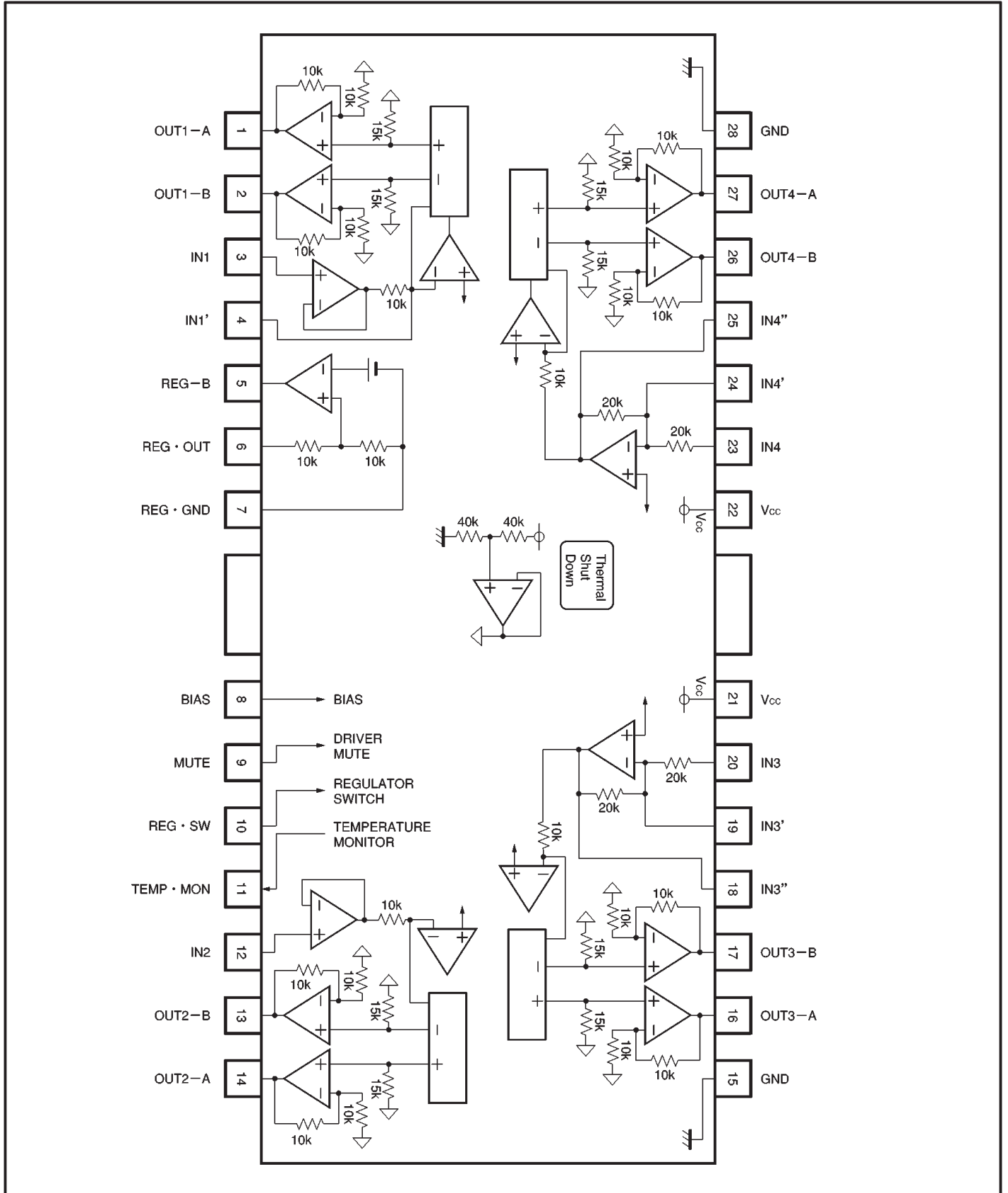

●Pin descriptions

Pin No.	Pin name	Function
1	OUT1—A	Channel 1 driver output
2	OUT2—B	Channel 1 driver output
3	IN1	Channel 1 input
4	IN1'	Adjusting channel 1 gain
5	REG—B	Base connection for regulator power transistor
6	REG · OUT	Base connection for regulator output power transistor
7	REG · GND	Regulator ground/common circuit ground*1
8	BIAS	Bias input
9	MUTE	Mute control
10	REG · SW	Regulator switch
11	TEMP · MON	Temperature monitor*2
12	IN2	Channel 2 input
13	OUT2—B	Channel 2 driver output
14	OUT2—A	Channel 2 driver output
15	GND	Substrate ground
16	OUT3—A	Channel 3 driver output
17	OUT3—B	Channel 3 driver output
18	IN3''	Adjusting channel 3 gain
19	IN3'	Adjusting channel 3 gain
20	IN3	Channel 3 input
21	V _{CC}	V _{CC}
22	V _{CC}	V _{CC}
23	IN4	Channel 4 input
24	IN4'	Adjusting channel 4 gain
25	IN4''	Adjusting channel 4 gain
26	OUT4—B	Channel 4 driver output
27	OUT4—A	Channel 4 driver output
28	GND	Substrate ground

*1 Also serves as a common circuit ground and so should be connected to the ground pin even when the regulator is not used.

*2 See operation notes

●Electrical characteristics (unless otherwise noted, $T_a = 25^\circ\text{C}$, $V_{CC} = 8\text{V}$, $f = 1\text{kHz}$, $R_L = 8\Omega$)

Parameter	Symbol	Min.	Typ.	Max.	Unit	Conditions	Measurement Circuit
Quiescent current dissipation 1	I_{Q1}	5.5	11.0	14.5	mA	No load, mute off, regulator on	Fig. 1
Quiescent current dissipation 2	I_{Q2}	—	—	6.0	mA	No load, mute on, regulator off	Fig. 1
〈Drivers〉							
Output offset voltage	V_{OO}	−100	—	100	mV	Preamplifier buffer configured	Fig. 1
Max. output amplitude	V_{OM}	5.0	5.4	—	V		Fig. 1
Closed loop voltage gain 1	G_{VC1}	14.1	15.6	17.1	dB	$V_{IN} = 0.1 V_{rms}$, channels 1 and 2	Fig. 1
Closed loop voltage gain 2	G_{VC2}	13.6	15.6	17.6	dB	$V_{IN} = 0.1 V_{rms}$, channels 3 and 4	Fig. 1
MUTE-OFF voltage	V_{MOFF}	2.0	—	—	V		Fig. 1
MUTE-ON voltage	V_{MON}	—	—	0.5	V		Fig. 1
Ripple rejection ratio	RR	—	60	—	dB	$V_{IN} = 0.1 V_{rms}$, 100Hz	Preamplifier buffer configured
Interchannel crosstalk	CT	—	60	—	dB	$V_{IN} = 0.1 V_{rms}$, 1kHz	
〈Pre-stage operational amplifier〉							
Input bias current	I_B	—	—	300	nA		Fig. 1
Common mode input voltage	V_{ICM}	0	—	6.8	V		Fig. 1
Output high level voltage	V_{OHOP}	6.6	7.1	—	V		Fig. 1
Output low level voltage	V_{OLOP}	—	0.8	1.1	V		CH1 CH2 Excluding channel 2
Output high level current	I_{OHOP}	2	—	—	mA	Ground at 100Ω output	
Output low level current	I_{OLOP}	5	—	—	mA	V_{CC} at 100Ω output	Fig. 1
Slew rate	SR_{OP}	—	2	—	V/μs	100 kHz sq. wave, 3 V _{P-P} output	Fig. 1
〈5 V regulator〉							
Output voltage	V_{reg}	4.75	5.00	5.25	V	$I_L = 100\text{mA}$	Fig. 1
Output load	ΔV_{RL}	−50	0	10	mV	$I_L = 0 \sim 200\text{mA}$	Fig. 1
Supply voltage	ΔV_{VCC}	−10	0	25	mV	($V_{CC} = 6 \sim 9\text{V}$) $I_L = 100\text{mA}$	Fig. 1
Ripple rejection ratio	RR_{REG}	—	50	—	dB	$V_{IN} = 1V_{P-P}$ 1kHz	Fig. 1
Regulator switch-on voltage	V_{REGON}	2.0	—	—	V		Fig. 1
Regulator switch-off voltage	V_{REGOFF}	—	—	0.5	V		Fig. 1

©Not designed for radiation resistance.

●Application example

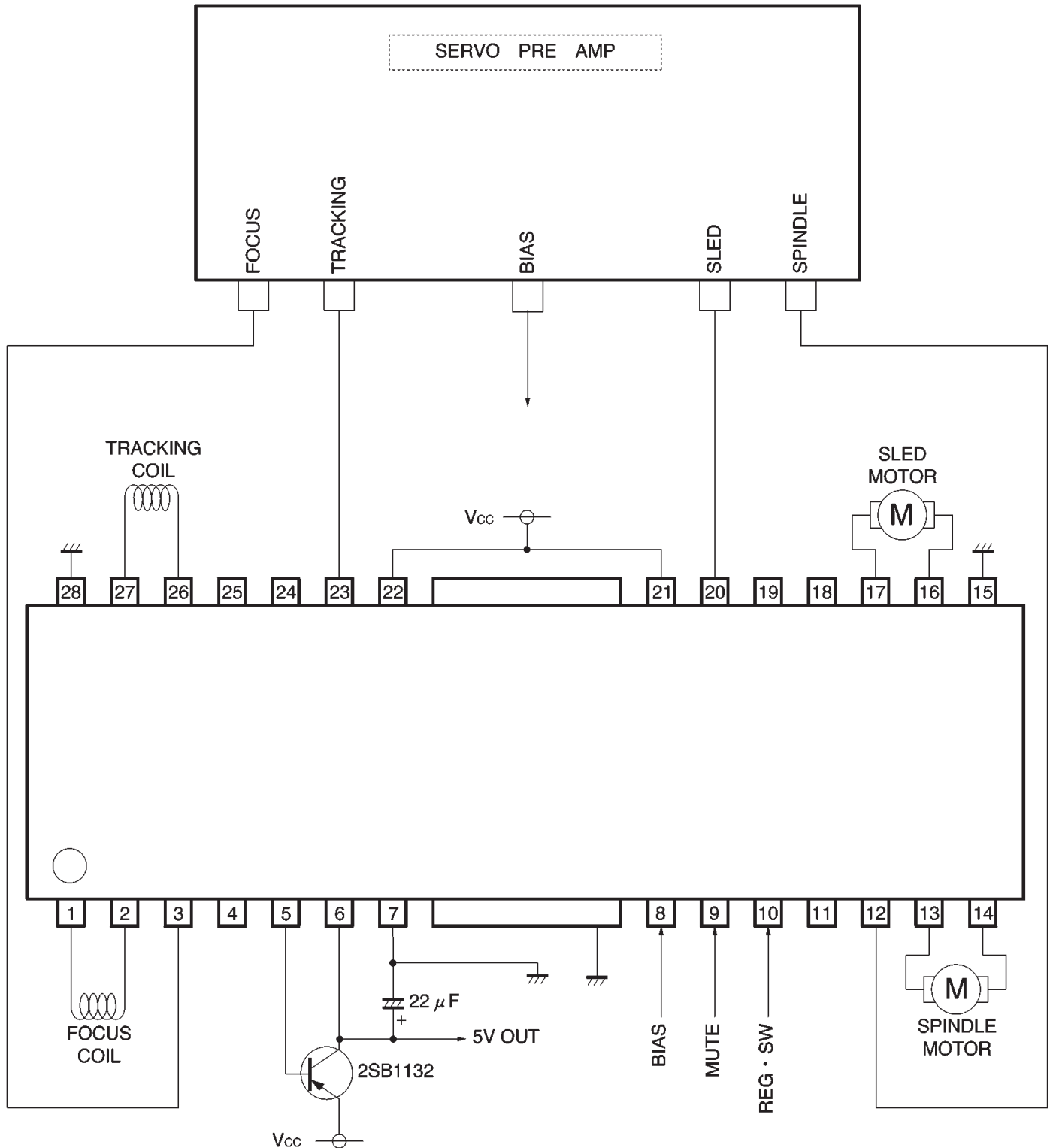

Fig. 1

●Operation notes

- (1) The BA6997FP and BA6997FM have an internal thermal shutdown circuit. Output current is muted when the chip temperature exceeds 175°C (typically).
- (2) The output current can be muted by opening the mute pin (pin 9) voltage or lowering it below 0.5V. This pin should be pulled up above 2.0V during normal operation. When muting occurs, the output pins output the internal bias voltage, roughly $V_{CC}/2$.
- (3) The regulator can be turned off by opening the regulator switch (pin 10) or lowering it below 0.5V. This pin should be pulled up above 2.0V during normal operation.
- (4) Muting also occurs when the bias pin (8 pin) voltage drops below 1.4V (typically). This pin should stay above 1.6V during normal operation.
- (5) Attach a bypass capacitor (roughly 0.1 μ F) to the power supply, at the base of the IC.
- (6) Be sure to connect the radiating fin to an external ground.

- (7) The capacitor between regulator output (pin 6) and REGGND (pin 7) also serves to prevent oscillation of the IC, so select one with good temperature characteristics.
- (8) We recommend 2SB1132 as the PNP transistor to attach to the regulator.
- (9) The internal circuitry of the temperature monitor pin is shown in the diagram below. Note that the internal reference voltage is also used for the 5V regulator, which will cease to operate normally when the temperature monitor pin emits a current exceeding the regulator's capacity. Set I to several dozen μ A.

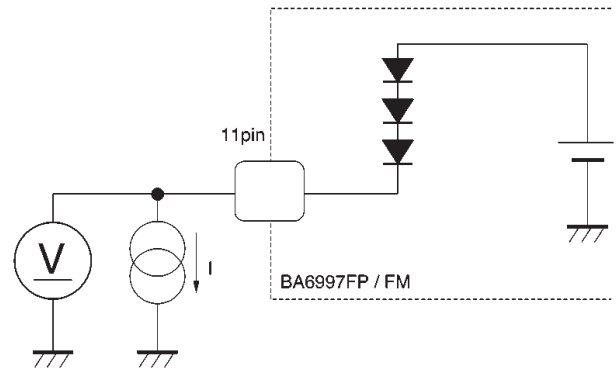

Fig. 2

●Electrical characteristic curves

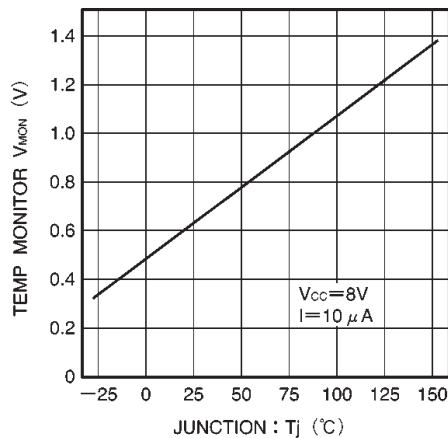

Fig. 3 T_j vs. V_{MON}

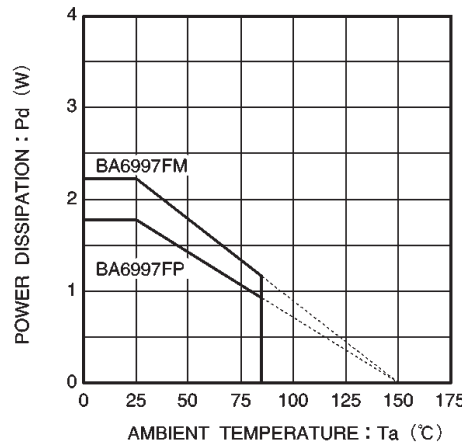

Fig. 4 Thermal derating curve

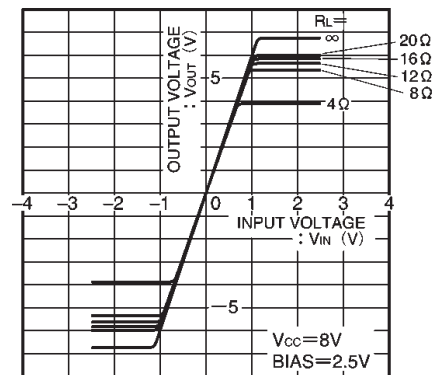

Fig. 5 Driver I / O characteristics (variable load)

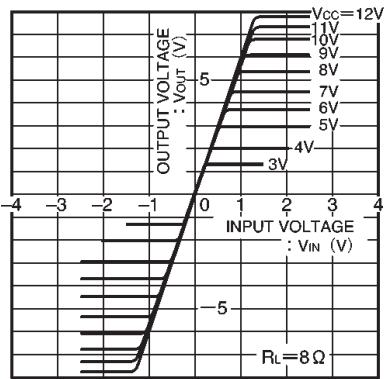

Fig. 6 Driver I / O characteristics (variable V_{cc})

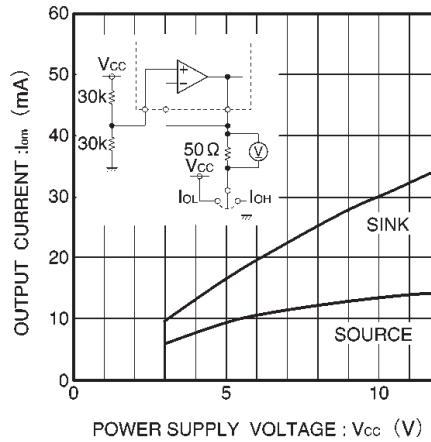

Fig. 7 Power supply voltage vs. operational amplifier output drive current

● External dimensions (Units: mm)

