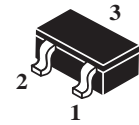
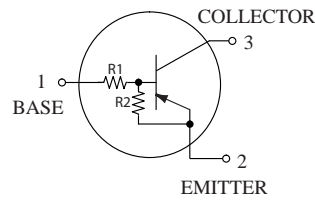

**Bias Resistor Transistor
PNP Silicon**

SC-59
Maximum Ratings ($T_A=25^\circ\text{C}$ unless otherwise noted)

Rating	Symbol	Value	Unit
Collector-Emitter Voltage	V_{CEO}	50	Vdc
Collector-Base Voltage	V_{CBO}	50	Vdc
Collector Current-Continuous	I_C	100	mAdc

Thermal Characteristics

Characteristics	Symbol	Max	Unit
Total Device Dissipation FR-5 Board ⁽¹⁾ (1) $T_A=25^\circ\text{C}$ Derate above 25°C	P_D	230	mW
		1.8	mW/ $^\circ\text{C}$
Thermal Resistance, Junction to Ambient ⁽¹⁾	$R_{\theta JA}$	540	$^\circ\text{C}/\text{W}$
Junction and Storage, Temperature Range	T_J, T_{stg}	-55 to +150	$^\circ\text{C}$

1.FR-4 @ minimum pad

Device Marking and Resistor Values

Device	Marking	R1(K)	R2(K)	Device	Marking	R1(K)	R2(K)
MUN2111	6A	10	10	MUN2131	6H	2.2	2.2
MUN2112	6B	22	22	MUN2132	6J	4.7	4.7
MUN2113	6C	47	47	MUN2133	6K	4.7	47
MUN2114	6D	10	47	MUN2134	6L	22	47
MUN2115	6E	10	∞	MUN2136	6N	100	100
MUN2116	6F	4.7	∞	MUN2137	6P	47	22
MUN2130	6G	1.0	1.0	MUN2140	6T	47	∞

Electrical Characteristics (TA=25 °C Unless Otherwise noted)

Characteristics	Symbol	Min	Typ	Max	Unit
-----------------	--------	-----	-----	-----	------

Off Characteristics

Collector-Emitter Breakdown Voltage (2) ($I_C=2.0\text{mA}, I_B=0$)	V(BR)CEO	50	-	-	V
Collector-Base Breakdown Voltage ($I_C=10\text{ }\mu\text{A}, I_E=0$)	V(BR)CBO	50	-	-	V
Collector-Base Cutoff Voltage ($V_{CB}=50\text{V}, I_E=0$)	ICBO	-	-	100	nA
Collector-Emitter Cutoff Current ($V_{CE}=50\text{V}, I_B=0$)	ICEO	-	-	500	nA
Emitter-Base Cutoff Current ($V_{EB}=6.0\text{V}, I_C=0$)	IEBO	-	-	0.5	mA
MUN2111		-	-	0.2	
MUN2112		-	-	0.1	
MUN2113		-	-	0.2	
MUN2114		-	-	0.9	
MUN2115		-	-	1.9	
MUN2116		-	-	4.3	
MUN2130		-	-	2.3	
MUN2131		-	-	1.5	
MUN2132		-	-	0.18	
MUN2133		-	-	0.13	
MUN2134		-	-	0.05	
MUN2136		-	-	0.13	
MUN2137		-	-	0.20	
MUN2140		-	-		

On Characteristics

Collector-Emitter Saturation Voltage ($I_C=10\text{mA}, I_B=0.3\text{mA}$)	VCE(sat)	-	-	0.25	Vdc
MUN2111		-	-	0.25	
MUN2112		-	-	0.25	
MUN2113		-	-	0.25	
MUN2114		-	-	0.25	
MUN2115		-	-	0.25	
MUN2130		-	-	0.25	
MUN2136		-	-	0.25	
MUN2137		-	-	0.25	
($I_C=10\text{mA}, I_B=5\text{mA}$)		-	-	0.25	
($I_C=10\text{mA}, I_B=1\text{mA}$)		-	-	0.25	
MUN2131		-	-	0.25	
MUN2116		-	-	0.25	
MUN2132		-	-	0.25	
MUN2134		-	-	0.25	
MUN2140		-	-	0.25	

2. Pulse Test: Pulse Width < 300 us, Duty Cycle < 2.0%

Electrical Characteristics (TA=25°C Unless Otherwise noted)

Characteristics	Symbol	Min	Typ	Max	Unit
-----------------	--------	-----	-----	-----	------

On Characteristics (2)

DC Current Gain (VCE=-10V, IC=-5.0mA)	MUN2111	hFE	35	60	-		
	MUN2112		60	100	-		
	MUN2113		80	140	-		
	MUN2114		80	140	-		
	MUN2115		160	250	-		
	MUN2116		160	250	-		
	MUN2130		3.0	5.0	-		
	MUN2131		8.0	15	-		
	MUN2132		15	27	-		
	MUN2133		80	140	-		
	MUN2134		80	130	-		
	MUN2136		80	150	-		
	MUN2137		80	140	-		
	MUN2140		120	250	-		
Output Voltage(on) (VCC=5.0V, VB=2.5V, RL=1.0kΩ)	MUN2111	VOL	-	-	0.2	Vdc	
	MUN2112		-	-	0.2		
	MUN2114		-	-	0.2		
	MUN2115		-	-	0.2		
	MUN2116		-	-	0.2		
	MUN2130		-	-	0.2		
	MUN2131		-	-	0.2		
	MUN2132		-	-	0.2		
	MUN2133		-	-	0.2		
	MUN2134		-	-	0.2		
	(VCC=5.0V, VB=3.5V, RL=1.0kΩ)		MUN2113	-	-		0.2
	(VCC=5.0V, VB=5.5V, RL=1.0kΩ)		MUN2140	-	-		0.2
	(VCC=5.0V, VB=4.0V, RL=1.0kΩ)		MUN2136	-	-		0.2
	MUN2137	-	-	0.2			
Output Voltage(off) (VCC=5.0V, VB=0.5V, RL=1.0kΩ) (VCC=5.0V, VB=0.05V, RL=1.0kΩ) (VCC=5.0V, VB=0.25V, RL=1.0kΩ)	MUN2130	VOH	4.9	-	-	Vdc	
	MUN2115						
	MUN2116						
	MUN2131						
	MUN2132						
	MUN2140						

2. Pulse Test: Pulse Width<300 us, Duty Cycle<2.0%

Electrical Characteristics (TA=25°C Unless Otherwise noted)

Characteristics	Symbol	Min	Typ	Max	Unit
-----------------	--------	-----	-----	-----	------

On Characteristics (2)

Input Resistor	MUN2111	R1	7.0	10	13	kΩ
	MUN2112		15.4	22	28.6	
	MUN2113		32.9	47	61.1	
	MUN2114		7.0	10	13	
	MUN2115		7.0	10	13	
	MUN2116		3.3	4.7	6.1	
	MUN2130		0.7	1.0	1.3	
	MUN2131		1.5	2.2	2.9	
	MUN2132		3.3	4.7	6.1	
	MUN2133		3.3	4.7	6.1	
	MUN2134		15.4	22	28.6	
	MUN2136		70	100	130	
	MUN2137		32.9	47	61.1	
	MUN2140		32.9	47	61.1	
Resistor Ratio MUN2111/MUN2112/MUN2113	R1/R2	0.8	1.0	1.2		
MUN2136		0.17	0.21	0.25		
MUN2114		-	-	-		
MUN2115/MUN2116/MUN2140		0.8	1.0	1.2		
MUN2130/MUN2131/MUN2132		0.055	0.1	0.185		
MUN2133		0.38	0.47	0.56		
MUN2134		1.7	2.1	2.6		
MUN2137						

2. Pulse Test: Pulse Width < 300 us, Duty Cycle < 2.0 %

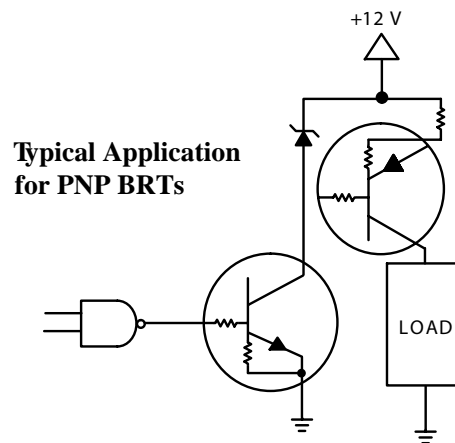
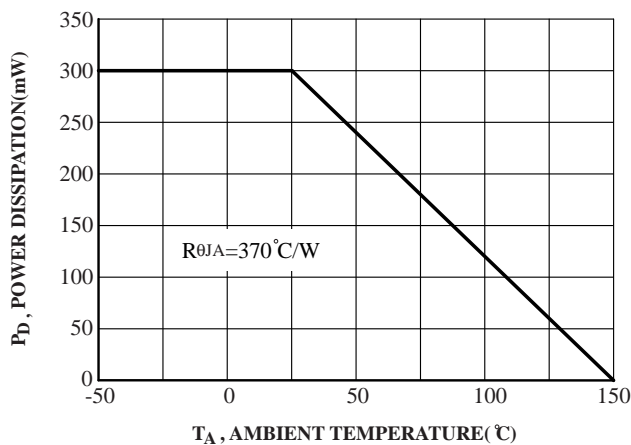

FIG.2 Inexpensive, Unregulated Current Source

MUN2111 Series

TYPICAL ELECTRICAL CHARACTERISTICS-MUN2111

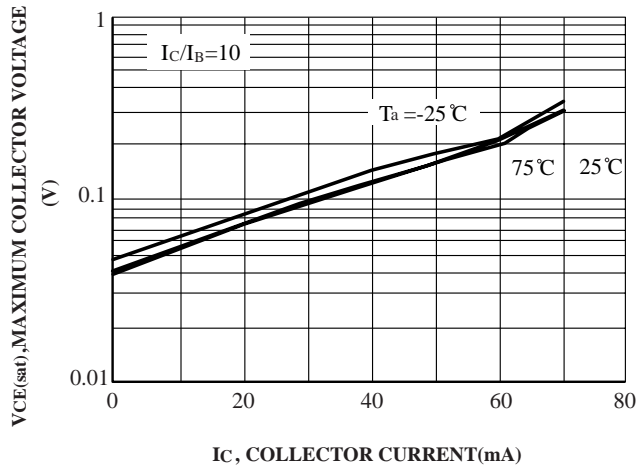

FIG.3 $V_{CE(sat)}$ vs. I_C

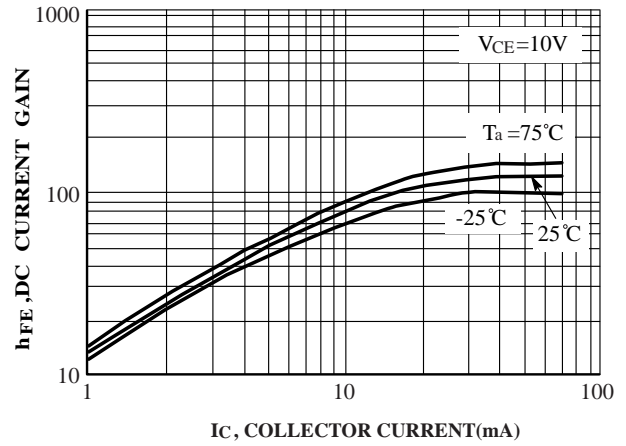

FIG.4 DC Current Gain

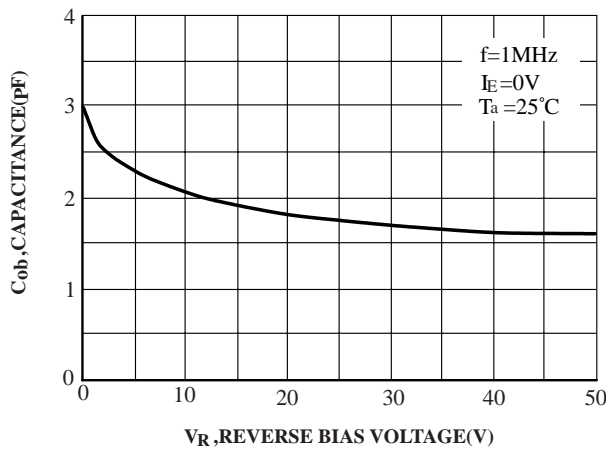

FIG.5 Output Capacitance

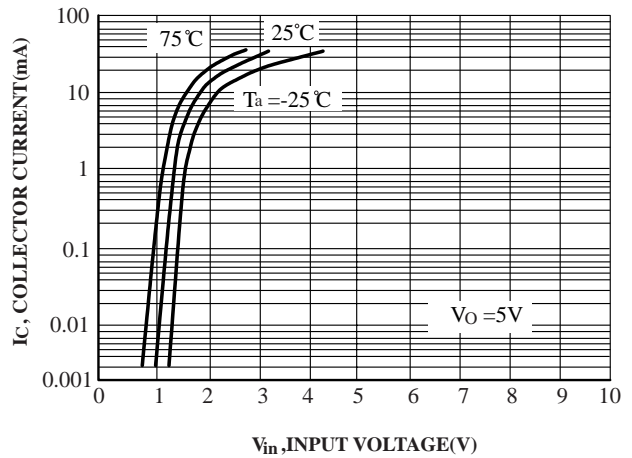

FIG.6 Output Current vs. Input Voltage

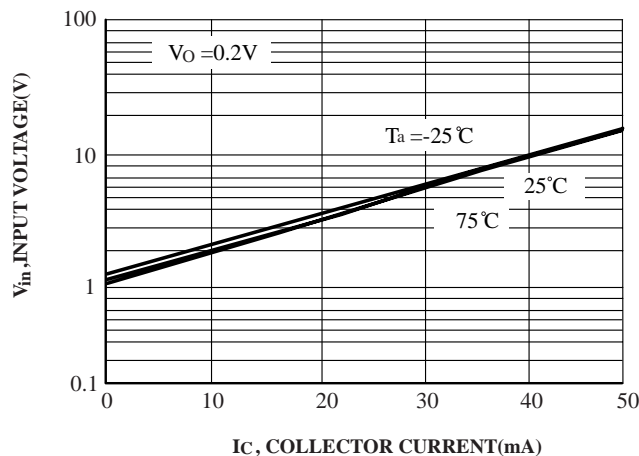
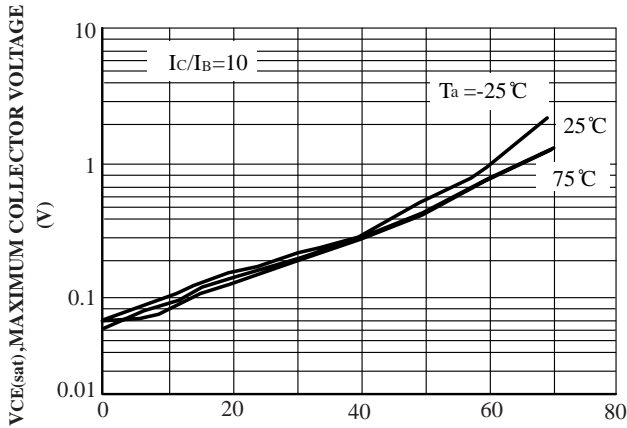

FIG.7 Input Voltage vs. Output Current

MUN2111 Series

TYPICAL ELECTRICAL CHARACTERISTICS-MUN2112



IC, COLLECTOR CURRENT(mA)
FIG.8 VCE(sat) vs. IC

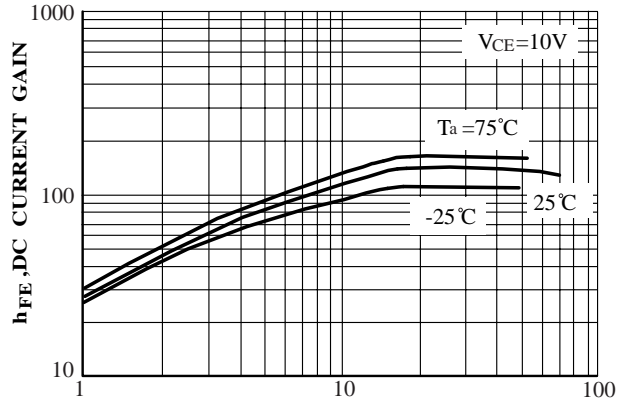

IC, COLLECTOR CURRENT(mA)
FIG.9 DC Current Gain

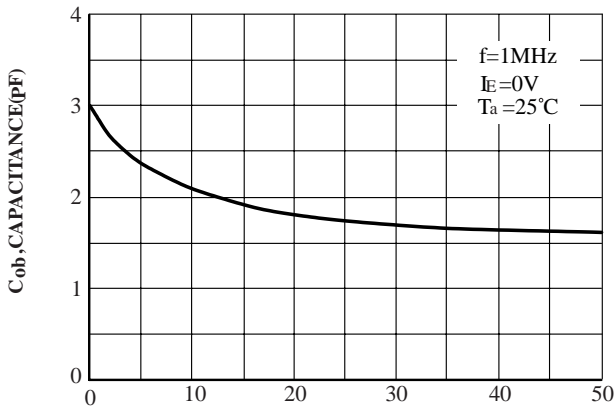

VR, REVERSE BIAS VOLTAGE(V)
FIG.10 Output Capacitance

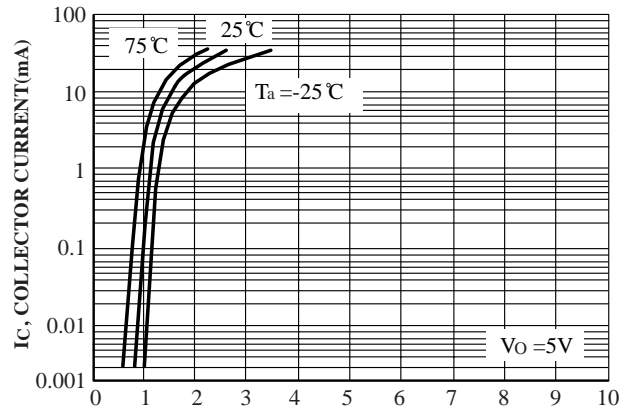

IC, COLLECTOR CURRENT (mA)
FIG.11 Output Current vs. Input Voltage

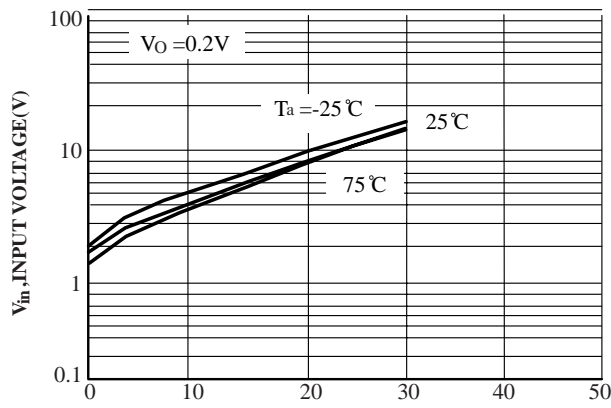

IC, COLLECTOR CURRENT(mA)
FIG.12 Input Voltage vs. Output Current

MUN2111 Series
TYPICAL ELECTRICAL CHARACTERISTICS-MUN2113

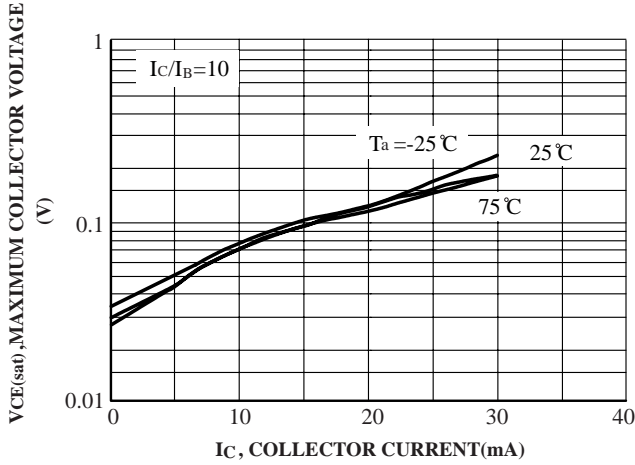

FIG.13 $V_{CE(sat)}$ vs. I_C

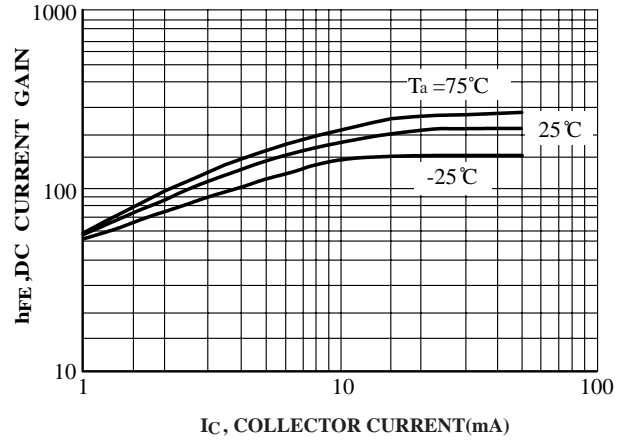

FIG.14 DC Current Gain

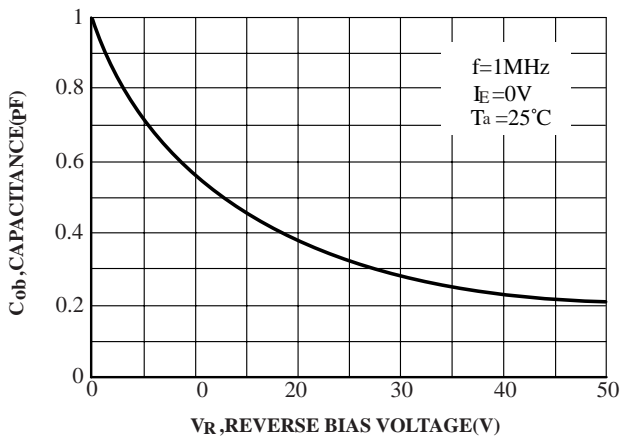

FIG.15 Output Capacitance

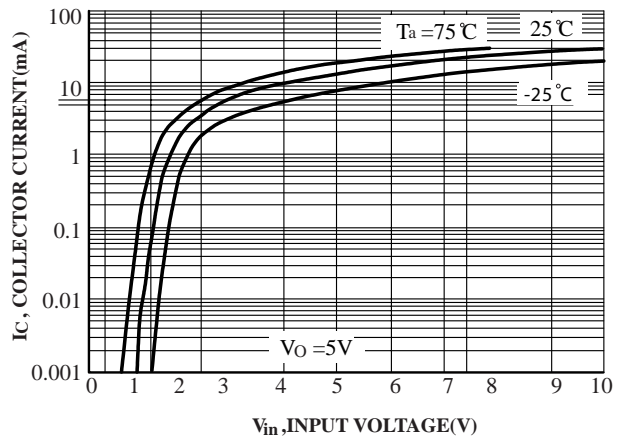

FIG.16 Output Current vs. Input Voltage

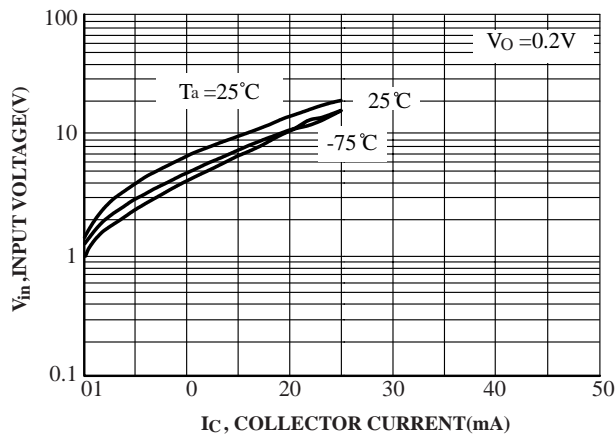

FIG.17 Input Voltage vs. Output Current

MUN2111 Series

TYPICAL ELECTRICAL CHARACTERISTICS-MUN2114

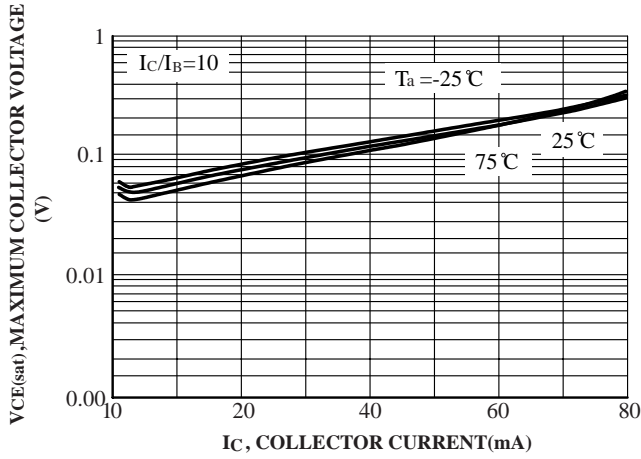

FIG.18 $V_{CE(sat)}$ vs. I_C

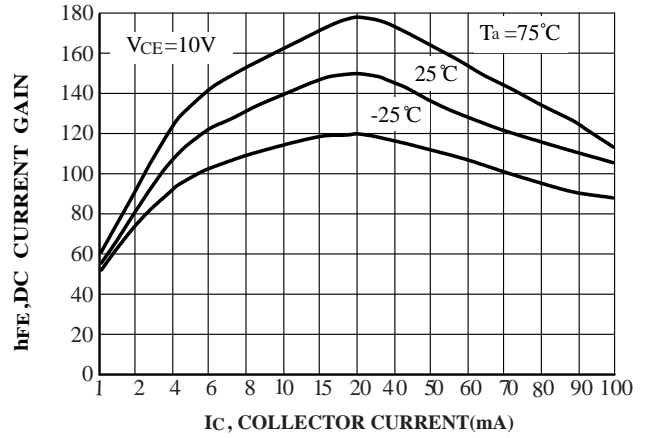

FIG.19 DC Current Gain

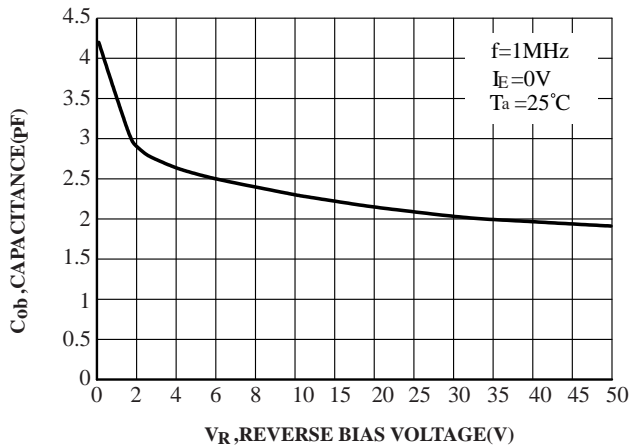

FIG.20 Output Capacitance

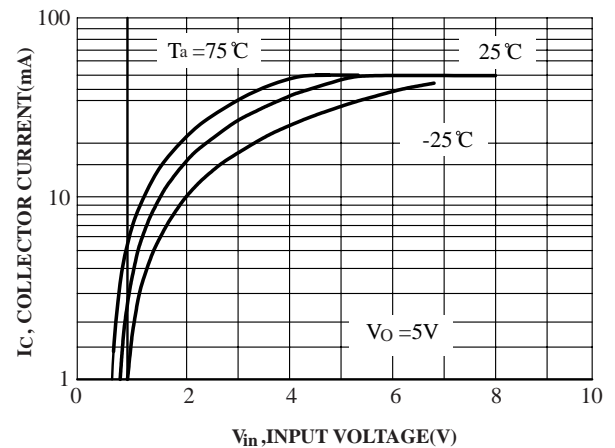

FIG.21 Output Current vs. Input Voltage

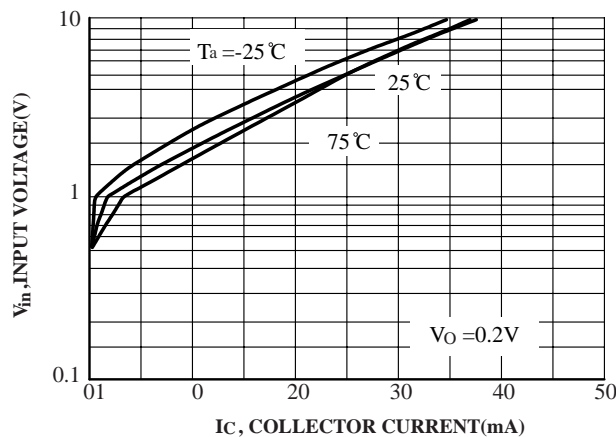

FIG.22 Input Voltage vs. Output Current

MUN2111 Series
TYPICAL ELECTRICAL CHARACTERISTICS-MUN2131

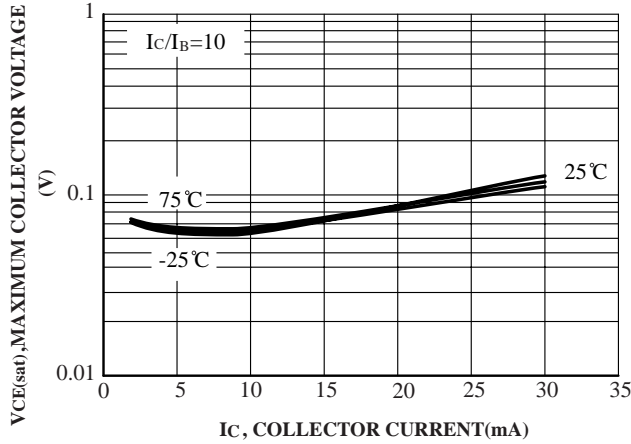

FIG.23 $V_{CE(sat)}$ vs. I_C

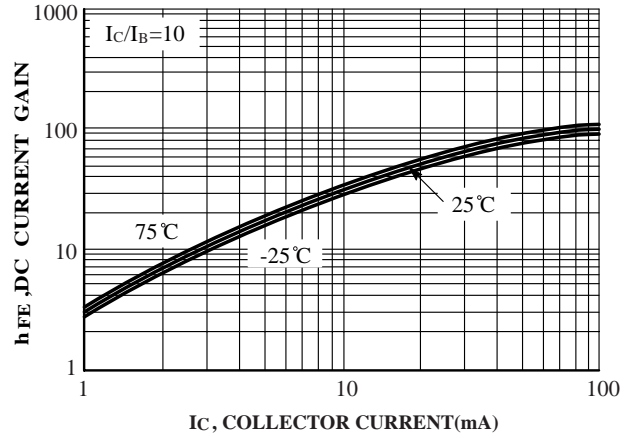

FIG.24 DC Current Gain

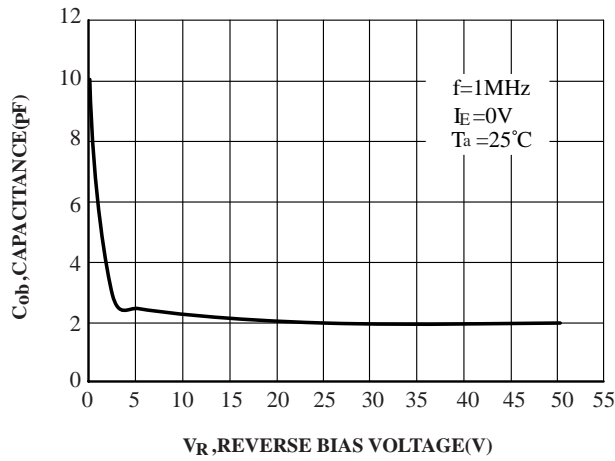

FIG.25 Output Capacitance

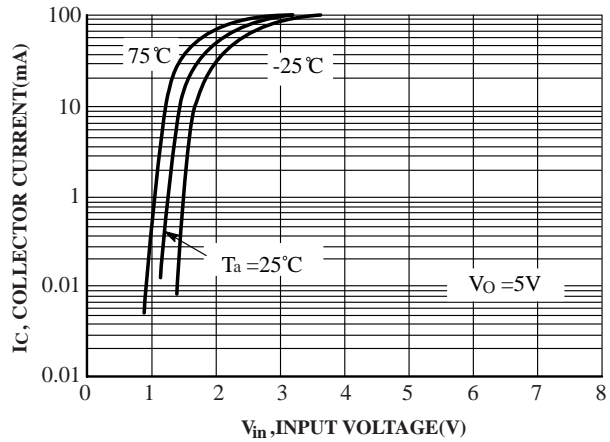

FIG.26 Output Current vs. Input Voltage

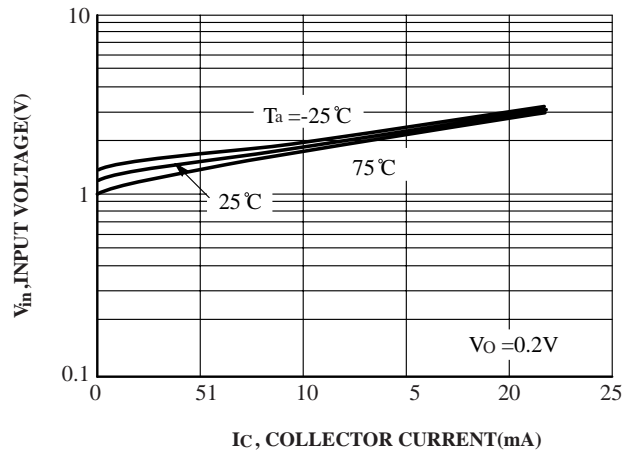

FIG.27 Input Voltage vs. Output Current

MUN2111 Series

TYPICAL ELECTRICAL CHARACTERISTICS-MUN2136

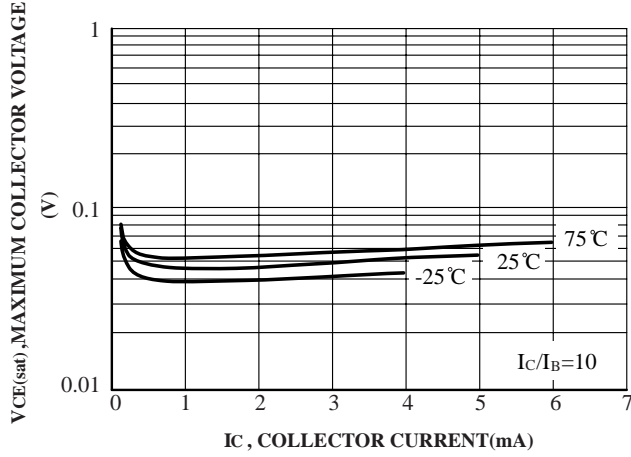

FIG.28 Maximum Collector Voltage versus Collector Current

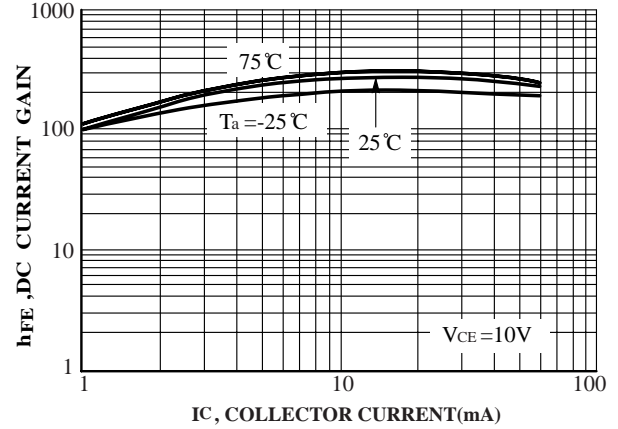

FIG.29 DC Current Gain

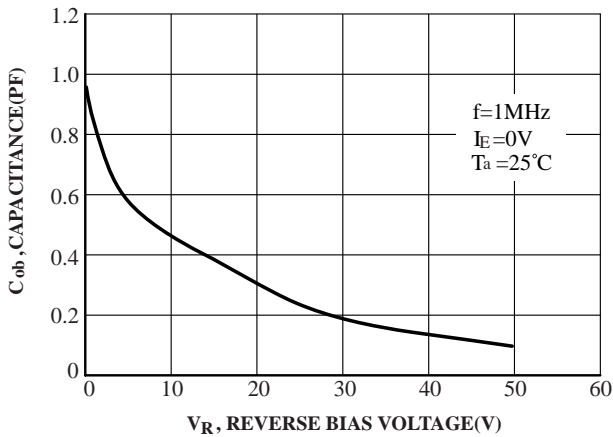

FIG.30 Output Capacitance

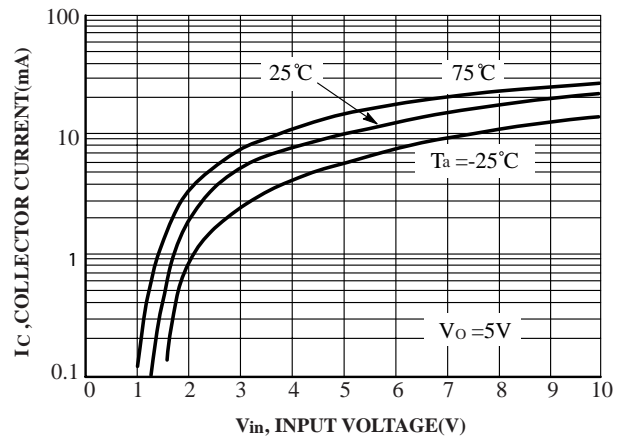

FIG.31 Output Current Versus Input Voltage

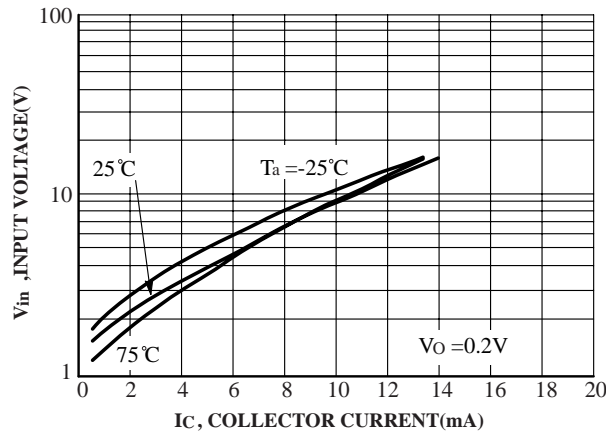

FIG.32 Input Voltage Versus Output Current

MUN2111 Series

TYPICAL ELECTRICAL CHARACTERISTICS-MUN2137

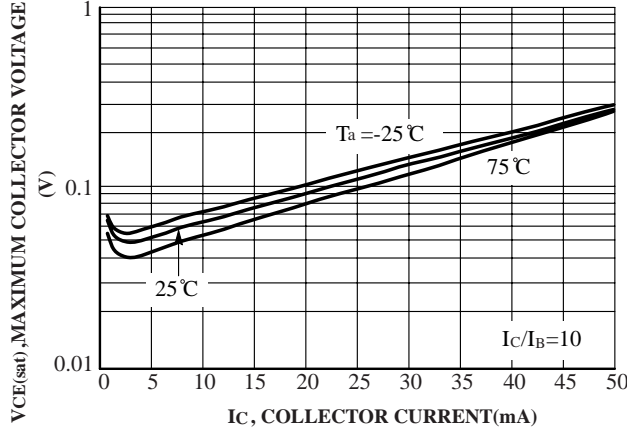

FIG.33 Maximum Collector Voltage Versus Collector Current

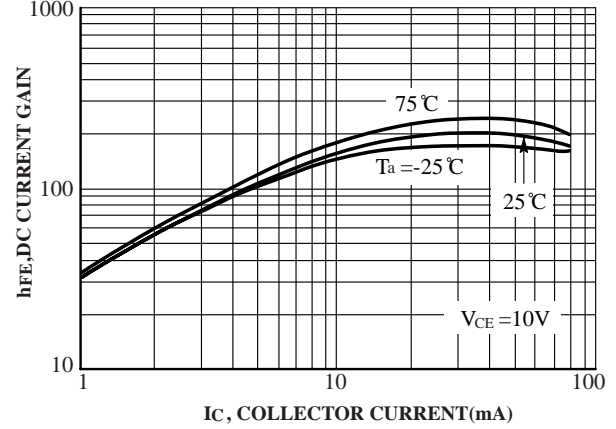

FIG.34 DC Current Gain

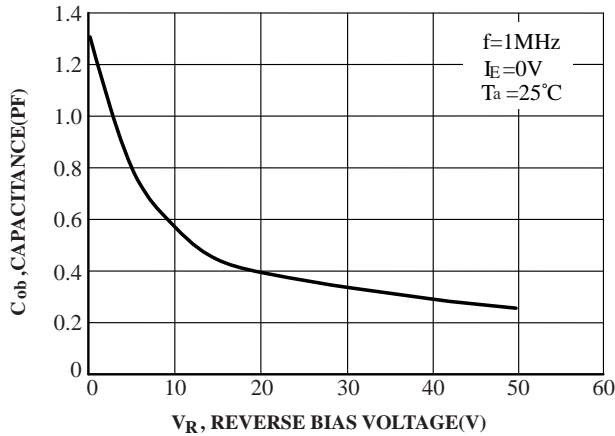

FIG.35 Output Capacitance

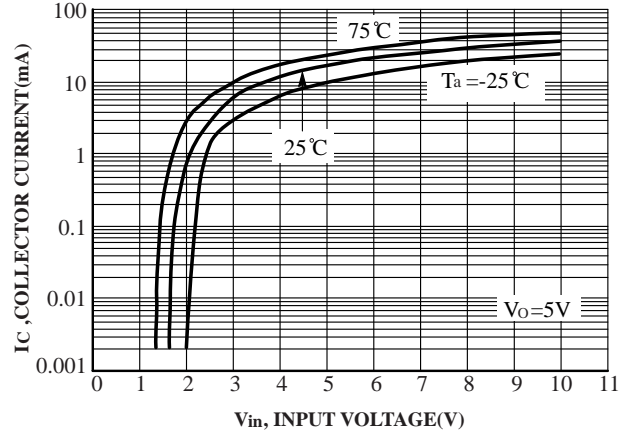

FIG.36 Output Current Versus Input Voltage

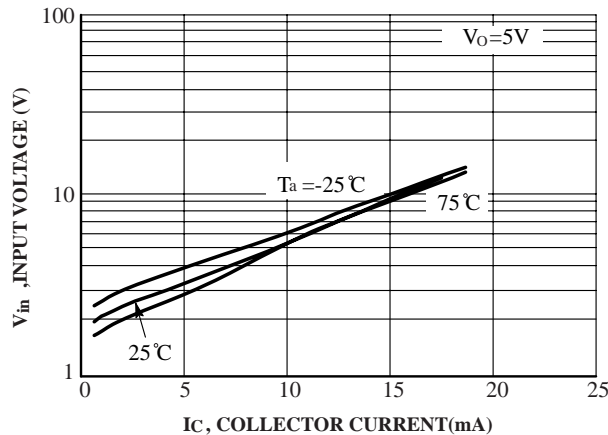

FIG.37 Input Voltage Versus Output Current

SC-59 Outline Dimension

