

Silicon PNP Power Transistors

2SB674

DESCRIPTION

- With TO-220C package
- DARLINGTON
- High DC current gain
- Low collector saturation voltage
- Complement to type 2SD634

APPLICATIONS

- High power switching applications
- Hammer drive,pulse motor drive applications

PINNING

PIN	DESCRIPTION
1	Base
2	Collector;connected to mounting base
3	Emitter

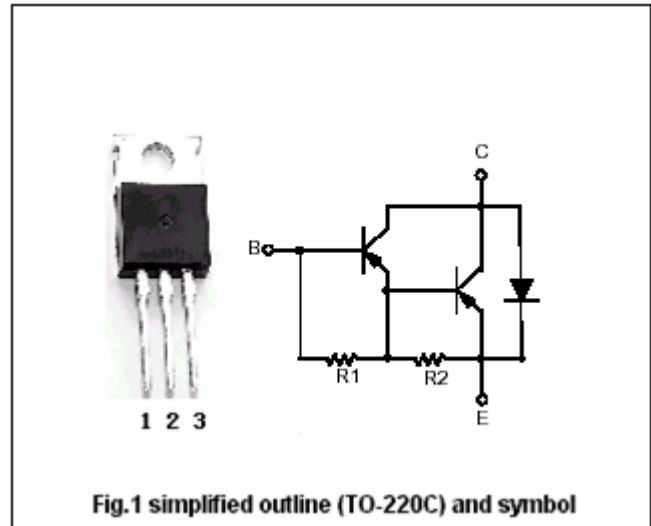
Absolute maximum ratings($T_c=25^\circ$)

SYMBOL	PARAMETER	CONDITIONS	VALUE	UNIT
V_{CBO}	Collector-base voltage	Open emitter	-80	V
V_{CEO}	Collector-emitter voltage	Open base	-80	V
V_{EBO}	Emitter-base voltage	Open collector	-5	V
I_C	Collector current		-7	A
I_B	Base current		-0.2	A
P_C	Collector power dissipation	$T_c=25^\circ$	40	W
T_j	Junction temperature		150	$^\circ$
T_{stg}	Storage temperature		-55~150	$^\circ$

Silicon PNP Power Transistors

2SB674

CHARACTERISTICS

T_j=25 °C unless otherwise specified

SYMBOL	PARAMETER	CONDITIONS	MIN	TYP.	MAX	UNIT
V _{(BR)CEO}	Collector-emitter breakdown voltage	I _C =-50mA, I _B =0	-80			V
V _{CEsat-1}	Collector-emitter saturation voltage	I _C =-3A, I _B =-6mA		-0.95	-1.5	V
V _{CEsat-2}	Collector-emitter saturation voltage	I _C =-7A, I _B =-14mA		-1.3	-2.0	V
V _{BEsat}	Base-emitter saturation voltage	I _C =-3A, I _B =-6mA		-1.55	-2.5	V
I _{CBO}	Collector cut-off current	V _{CB} =-80V, I _E =0			-0.1	mA
I _{EBO}	Emitter cut-off current	V _{EB} =-5V, I _C =0			-4.0	mA
h _{FE-1}	DC current gain	I _C =-3A ; V _{CE} =-3V	2000		15000	
h _{FE-2}	DC current gain	I _C =-7A ; V _{CE} =-3V	1000			

Switching times

t _{on}	Turn-on time	I _{B1} =-I _{B2} =-6mA V _{CC} =-45V, R _L =15Ω		0.8		μs
t _{stg}	Storage time			2.0		μs
t _f	Fall time			2.5		μs

Silicon PNP Power Transistors

2SB674

PACKAGE OUTLINE

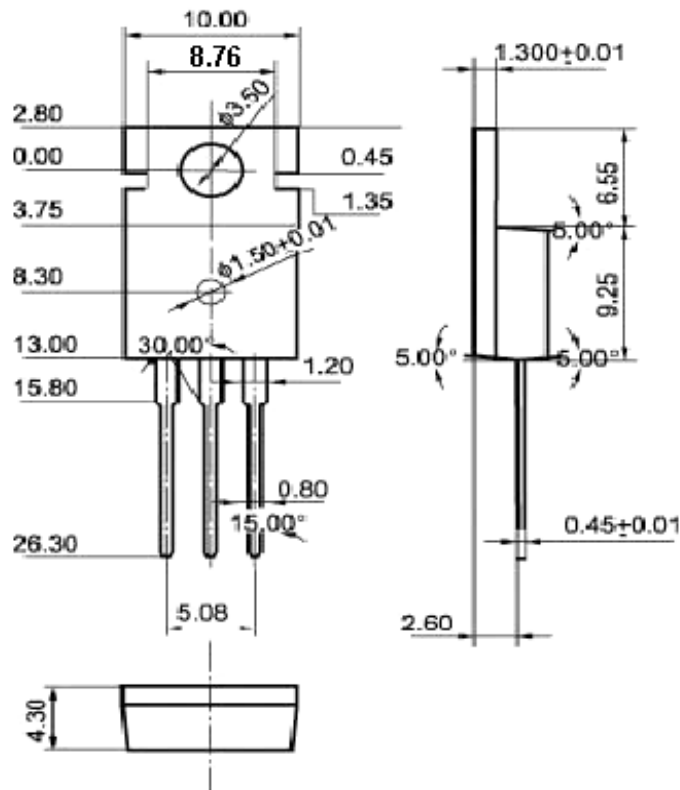

Fig.2 Outline dimensions