

## NPN Silicon AF Transistor

## BC 846 W ... BC 850 W

### Features

- For AF input stages and driver applications
- High current gain
- Low collector-emitter saturation voltage
- Low noise between 30Hz and 15 kHz
- Complementary types: BC 856 W, BC 857 W, BC 858 W, BC 859 W, BC 860 W (PNP)

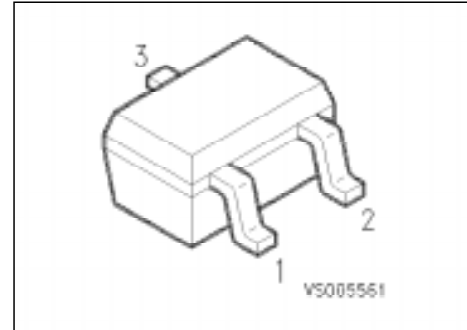

Type	Marking	Ordering code (tape and reel)	Pin Configuration			Package
			1	2	3	
BC 846 AW	1 As	Q62702-C2319	B	E	C	SOT 323
BC 846 BW	1 Bs	Q62702-C2279				SOT 323
BC 847 AW	1 Es	Q62702-C2304				SOT 323
BC 847 BW	1 Fs	Q62702-C2305				SOT 323
BC 847 CW	1 Gs	Q62702-C2306				SOT 323
BC 848 AW	1 Js	Q62702-C2307				SOT 323
BC 848 BW	1 Ks	Q62702-C2308				SOT 323
BC 848 CW	1 Ls	Q62702-C2309				SOT 323
BC 849 BW	2 Bs	Q62702-C2310				SOT 323
BC 849 CW	2 Cs	Q62702-C2311				SOT 323
BC 850 BW	2 Fs	Q62702-C2312				SOT 323
BC 850 CW	2 Gs	Q62702-C2313				SOT 323

### Maximum Ratings

Description	Symbol	BC846W	BC 847 W	BC 849 W	BC 848 W	Unit
		BC 840 W				
Collector-emitter voltage	$V_{CEO}$	65	45	30		V
Collector-base voltage	$V_{CBO}$	80	50	30		V
Collector-emitter voltage	$V_{CES}$	80	50	30		V
Emitter-base voltage	$V_{EBO}$	6	6	5		V
Collector current	$I_C$		100			mA
Collector peak current	$I_{CM}$		200			mA
Total power dissipation, $T_s = 115\text{ °C}$	$P_{tot}$		250			mW
Junction temperature	$T_j$		150			°C
Storage temperature range	$T_{stg}$		-65 to 150			°C

### Thermal Resistance

Junction - ambient <sup>1)</sup>	$R_{th JA}$	≤ 240	K/W
Junction - soldering point	$R_{th JS}$	≤ 105	K/W

<sup>1)</sup>Package mounted on epoxy pcb 40 mm × 40 mm × 1.5 mm/1 cm<sup>2</sup> Cu.

**Characteristic** at  $T_A = 25\text{ °C}$ , unless otherwise specified.

Description	Symbol	Ratings			Unit
		min.	typ.	max.	
<b>DC Characteristics</b>					
Collector-emitter breakdown voltage $I_C = 10\text{ mA}$	$V_{(BR)CEO}$				V
BC 846 W		65	–	–	
BC 847 W, BC 850 W		45	–	–	
BC 848 W, BC 849 W		30	–	–	
Collector-base breakdown voltage <sup>1)</sup> $I_C = 100\text{ }\mu\text{A}$	$V_{(BR)CBO}$				V
BC 846 W		80	–	–	
BC 847 W, BC 850 W		50	–	–	
BC 848 W, BC 849 W		30	–	–	
Collector-emitter breakdown voltage $I_C = 10\text{ }\mu\text{A}$ , $V_{BE} = 0$	$V_{(BR)CBO}$				V
BC 846 W		80	–	–	
BC 847 W, BC 850 W		50	–	–	
BC 848 W, BC 849 W		30	–	–	
Emitter-base breakdown voltage $I_E = 10\text{ }\mu\text{A}$	$V_{(BR)EBO}$				V
BC 846 W, BC 847 W		6	–	–	
BC 848 W, BC 849 W		5	–	–	
BC 850		–	–	–	
Collector-base cutoff current $V_{CB} = 30\text{ V}$ $V_{CB} = 30\text{ V}$ , $T_A = 150\text{ °C}$	$I_{CBO}$				nA $\mu\text{A}$
		–	–	15	
		–	–	5	
DC current gain	$h_{FE}$				–
$I_C = 10\text{ }\mu\text{A}$ , $V_{CE} = 5\text{ V}$					
BC 846 AW ... BC 848 AW		–	140	–	
BC 846 BW ... BC 850 BW		–	250	–	
BC 847 CW ... BC 850 CW		–	480	–	
$I_C = 2\text{ mA}$ , $V_{CE} = 5\text{ V}$					
BC 846 AW ... BC 848 AW		110	180	220	
BC 846 BW ... BC 850 BW		200	290	450	
BC 847 CW ... BC 850 CW		420	520	800	
Collector-emitter saturation voltage <sup>1)</sup> $I_C = 10\text{ mA}$ , $I_B = 0.5\text{ mA}$ $I_C = 100\text{ mA}$ , $I_B = 5\text{ mA}$	$V_{CEsat}$				mV
		–	90	250	
		–	900	650	
Base-emitter saturation voltage <sup>1)</sup> $I_C = 10\text{ mA}$ , $I_B = 0.5\text{ mA}$ $I_C = 100\text{ mA}$ , $I_B = 5\text{ mA}$	$V_{CEsat}$				mV
		–	700	–	
		–	900	–	
Base-emitter voltage <sup>1)</sup> $I_C = 2\text{ mA}$ , $V_{CE} = 0.5\text{ mA}$ $I_C = 10\text{ mA}$ , $V_{CE} = 5\text{ mA}$	$V_{CEsat}$				mV
		580	660	700	
		–	–	770	

<sup>1)</sup>Pulse test :  $t \leq 300\text{ }\mu\text{s}$ ,  $D = 2\text{ \%}$ .

**Characteristics** at  $T_A = 25\text{ °C}$ , unless otherwise specified.

Description	Symbol	Ratings			Unit
		min.	typ.	max.	
<b>AC Characteristics</b>					
Transition frequency $I_C = 20\text{ mA}$ , $V_{CE} = 5\text{ V}$ , $f = 100\text{ MHz}$	$f_T$	–	250	–	MHz
Output capacitance $V_{CB} = 10\text{ V}$ , $f = 1\text{ MHz}$	$C_{obo}$	–	2	–	pF
Input capacitance $V_{EB} = 0.5\text{ V}$ , $f = 1\text{ MHz}$	$C_{ibo}$	–	10	–	pF
Short-circuit input impedance $I_C = 2\text{ mA}$ , $V_{CE} = 5\text{ V}$ , $f = 1\text{ kHz}$	$h_{11e}$				kΩ
BC 846 AW ... BC 849 AW		–	2.7	–	
BC 846 BW ... BC 850 BW		–	4.5	–	
BC 847 CW ... BC 850 CW		–	8.7	–	
Open-circuit reverse voltage transfer ratio $I_C = 2\text{ mA}$ , $V_{CE} = 5\text{ V}$ , $f = 1\text{ kHz}$	$h_{12e}$				$10^{-4}$
BC 846 AW ... BC 849 AW		–	1.5	–	
BC 846 BW ... BC 850 BW		–	2.0	–	
BC 847 CW ... BC 850 CW		–	3.0	–	
Short-circuit forward current transfer ratio $I_C = 2\text{ mA}$ , $V_{CE} = 5\text{ V}$ , $f = 1\text{ kHz}$	$h_{21e}$				-
BC 846 AW ... BC 849 AW		–	200	–	
BC 846 BW ... BC 850 BW		–	330	–	
BC 847 CW ... BC 850 CW		–	600	–	
Open-circuit output admittance $I_C = 2\text{ mA}$ , $V_{CE} = 5\text{ V}$ , $f = 1\text{ kHz}$	$h_{22e}$				μS
BC 846 AW ... BC 849 AW		–	18	–	
BC 846 BW ... BC 850 BW		–	30	–	
BC 847 CW ... BC 850 CW		–	60	–	
Noise figure $I_C = 0.2\text{ mA}$ , $V_{CE} = 5\text{ V}$ , $R_s = 2\text{ kΩ}$ $f = 30\text{ Hz} \dots 15\text{ kHz}$ $f = 1\text{ kHz}$ , $\Delta f = 200\text{ Hz}$	$F$				dB
BC 849 W		–	1.4	4	
BC 850 W		–	1.4	3	
BC 849 W		–	1.2	4	
BC 850 W		–	1.0	4	
Equivalent noise voltage $I_C = 0.2\text{ mA}$ , $V_{CE} = 5\text{ V}$ , $R_s = 2\text{ kΩ}$ $f = 10\text{ Hz} \dots 50\text{ Hz}$	$V_n$				μV
BC 850 W		–	–	0.135	

**Curves see BC 846 ... BC 840**

### Total power dissipation $P_{tot} = f(T_A^*; T_S)$

\* Package mounted on epoxy

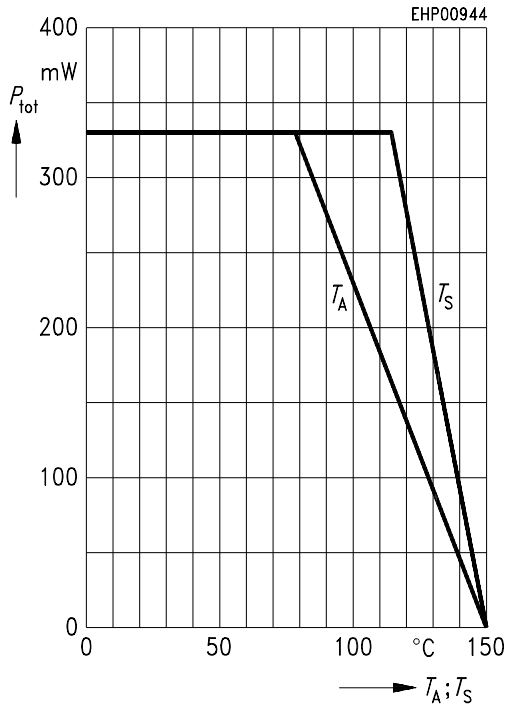

### Collector-base capacitance $C_{CB0} = f(V_{CB0})$

### Emitter-base capacitance $C_{EB0} = f(V_{EB0})$

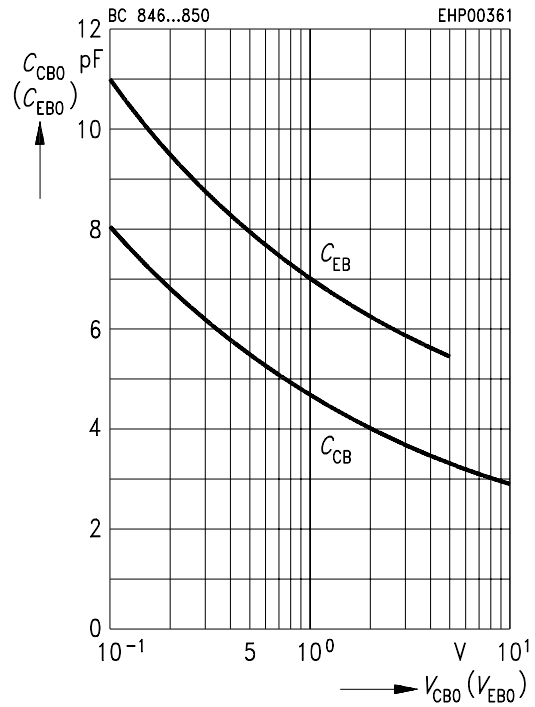

### Permissible pulse load $P_{tot max}/P_{tot DC} = f(t_p)$

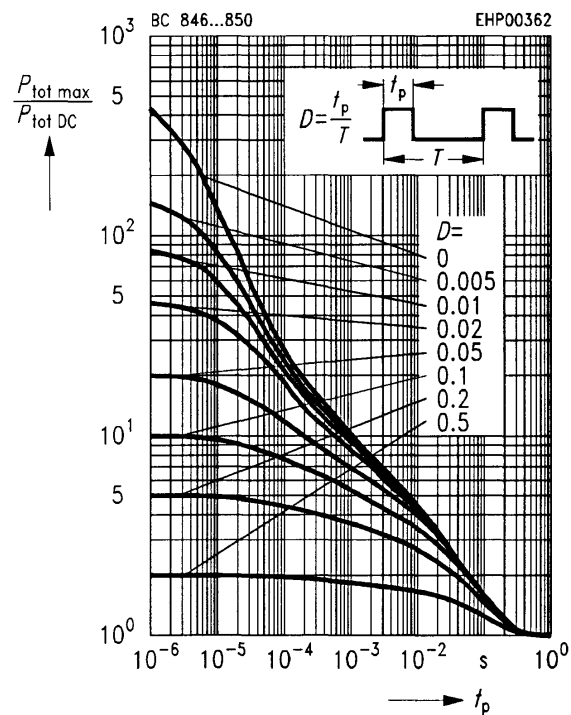

### Transition frequency $f_T = f(I_C)$

$V_{CE} = 5$  V

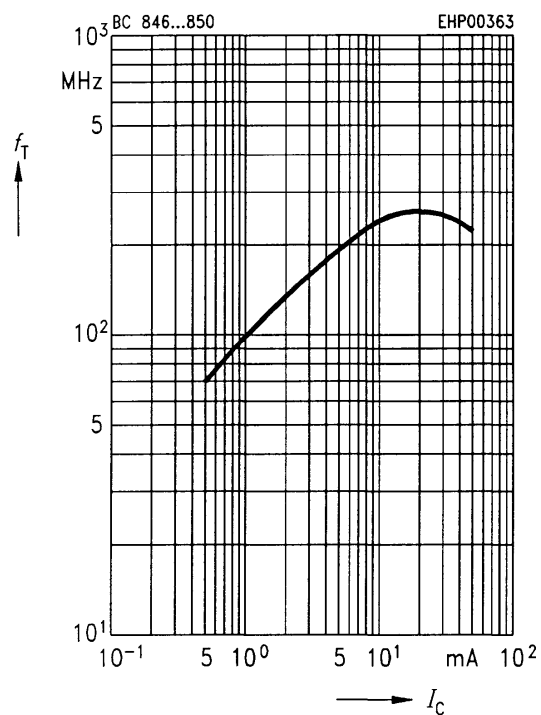

### Collector cutoff current $I_{CB0} = f(T_A)$

$V_{CB} = 30 \text{ V}$

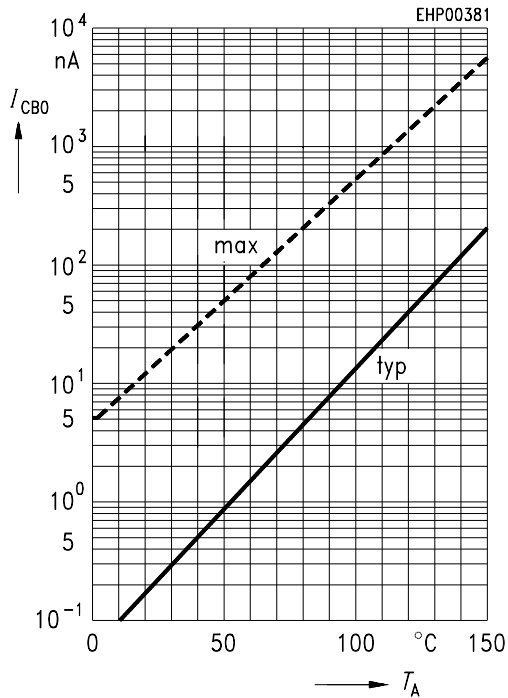

### Collector-emitter saturation voltage $I_C = f(V_{CEsat}, h_{FE} = 20)$

$I_C = f(V_{CEsat}, h_{FE} = 20)$

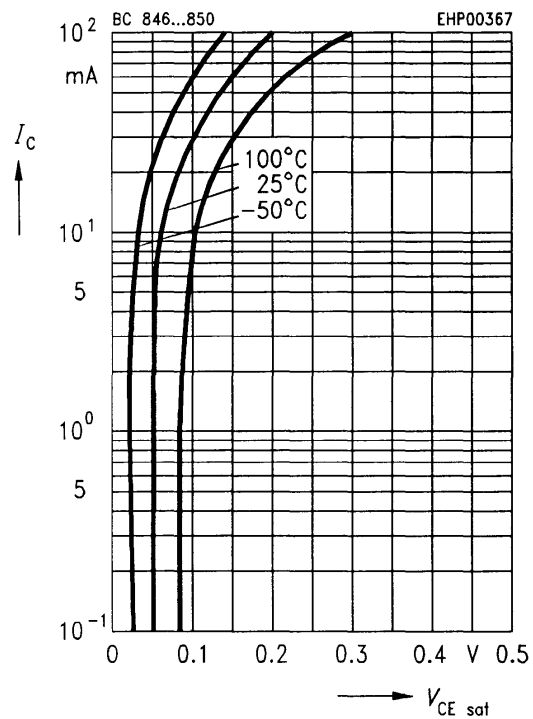

### DC current gain $h_{FE} = f(I_C)$

$V_{CE} = 5 \text{ V}$

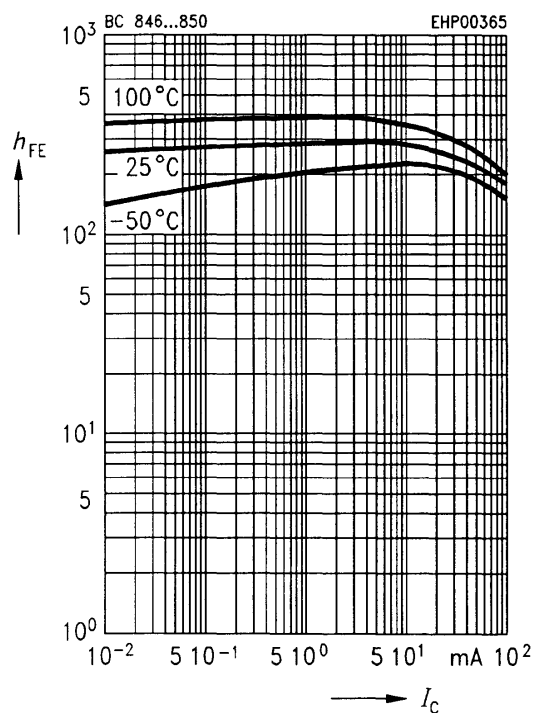

### Base-emitter saturation voltage $I_C = f(V_{BEsat}, h_{FE} = 20)$

$I_C = f(V_{BEsat}, h_{FE} = 20)$

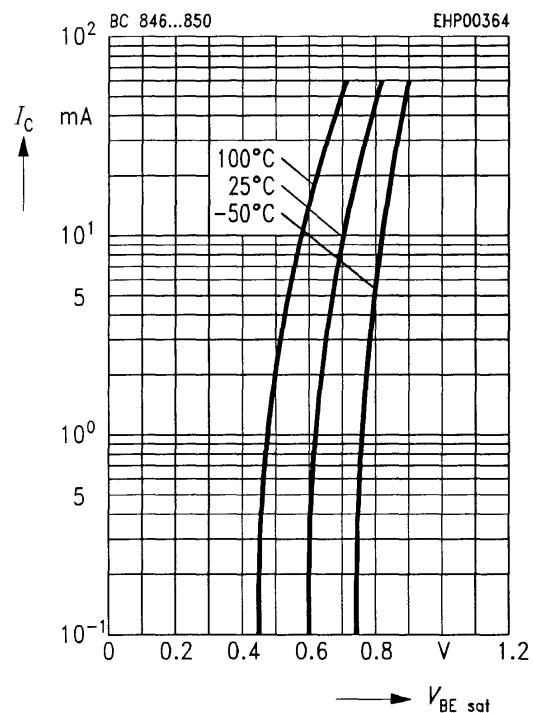

**h parameter  $h_e = f(I_C)$  normalized**  
 $V_{CE} = 5\text{ V}$

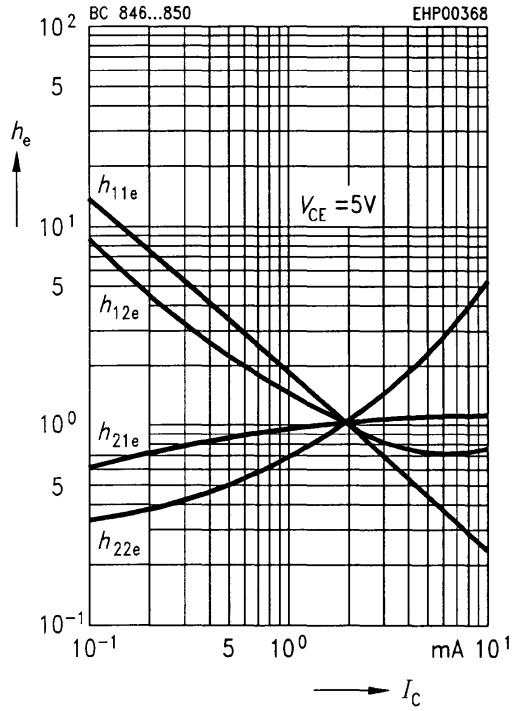

**h parameter  $h_e = f(V_{CE})$  normalized**  
 $I_C = 2\text{ mA}$

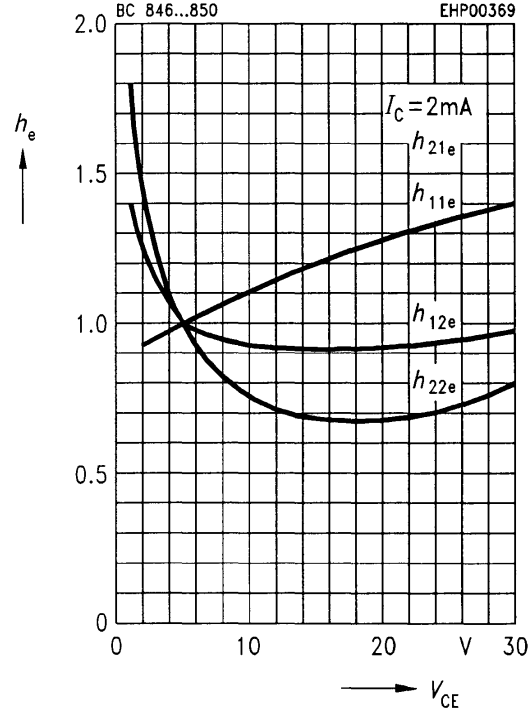

**Noise figure  $F = f(V_{CE})$**   
 $I_C = 0.2\text{ mA}$ ,  $R_s = 2\text{ k}\Omega$ ,  $f = 1\text{ kHz}$

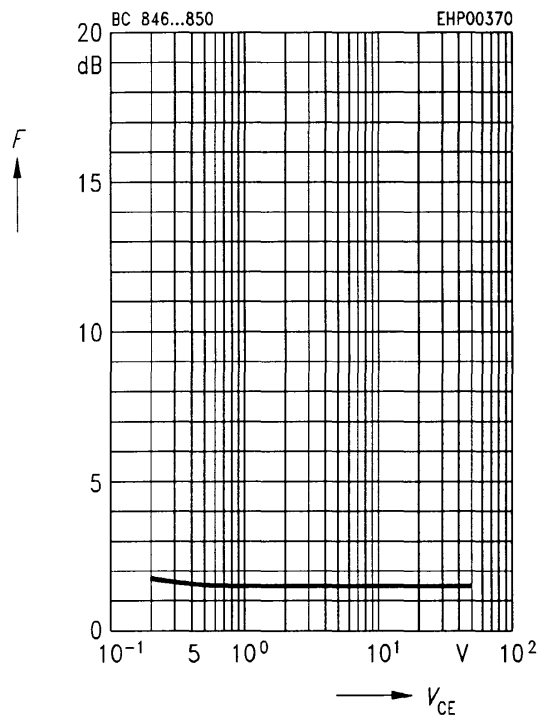

**Noise figure  $F = f(f)$**   
 $I_C = 0.2\text{ mA}$ ,  $V_{CE} = 5\text{ V}$ ,  $R_s = 2\text{ k}\Omega$

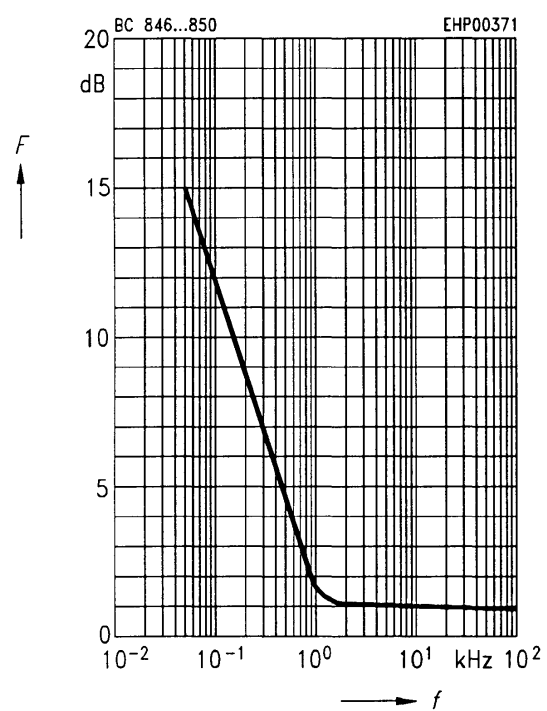

**Noise figure  $F = f(I_C)$**

$V_{CE} = 5 \text{ V}, f = 120 \text{ Hz}$

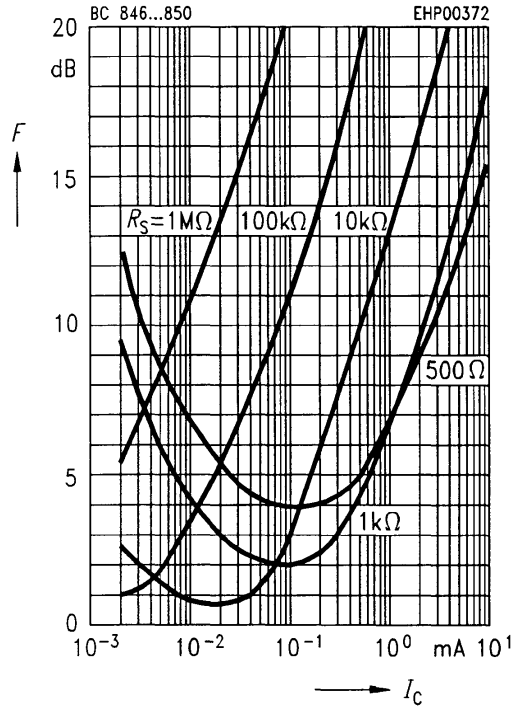

**Noise figure  $F = f(I_C)$**

$V_{CE} = 5 \text{ V}, f = 1 \text{ kHz}$

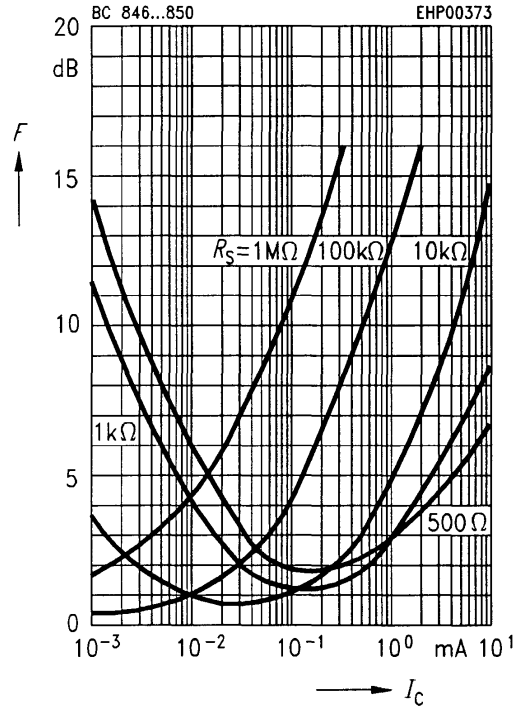

**Noise figure  $F = f(I_C)$**

$V_{CE} = 5 \text{ V}, f = 10 \text{ kHz}$

