

**General Purpose NPN Epitaxial Planar Transistor**

# BC817N3

**Description**

- The BC817N3 is designed for general purpose switching and amplification applications.
- Complementary to BC807N3.

**Features**

- High current (max. 500mA)
- Low voltage (max 45V).

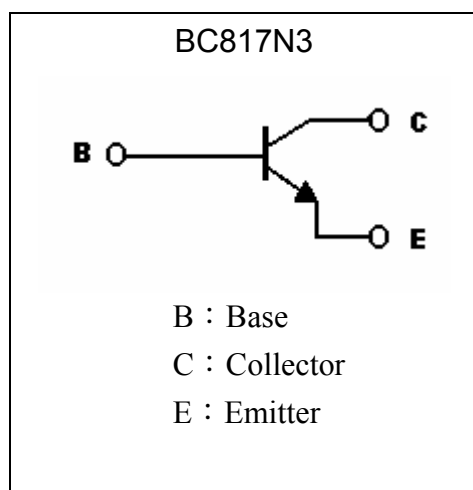
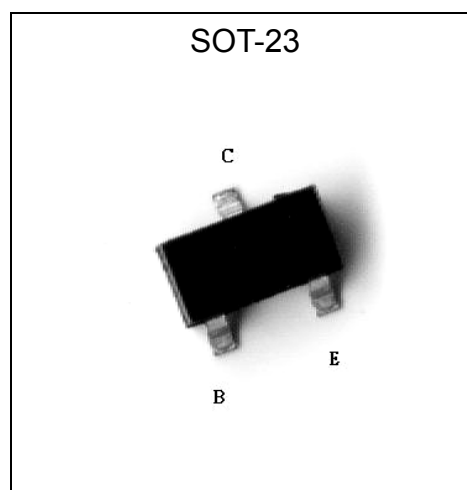
**Symbol**

**Outline**

**Absolute Maximum Ratings** (Ta=25°C)

Parameter	Symbol	Limits	Unit
Collector-Base Voltage	V <sub>CB0</sub>	50	V
Collector-Emitter Voltage	V <sub>CEO</sub>	45	V
Emitter-Base Voltage	V <sub>EB0</sub>	5	V
Collector Current (DC)	I <sub>C</sub>	500	mA
Collector Current (Pulse)	I <sub>CP</sub>	1	A
Power Dissipation	P <sub>d</sub>	225	mW
Junction Temperature	T <sub>j</sub>	150	°C
Storage Temperature	T <sub>stg</sub>	-55~+150	°C



**Characteristics (Ta=25°C)**

Symbol	Min.	Typ.	Max.	Unit	Test Conditions
$BV_{CBO}$	50	-	-	V	$I_C=10\mu A$
$BV_{CEO}$	45	-	-	V	$I_C=1mA$
$BV_{EBO}$	5	-	-	V	$I_E=10\mu A$
$I_{CBO}$	-	-	100	nA	$V_{CE}=20V$
$I_{EBO}$	-	-	100	nA	$V_{EB}=5V$
* $V_{CE(sat)}$	-	-	700	mV	$I_C=500mA, I_B=50mA$
* $V_{BE(on)}$	-	-	1.2	V	$V_{CE}=1V, I_C=500mA$
* $h_{FE1}$	100	-	600		$V_{CE}=1V, I_C=100mA$
* $h_{FE2}$	40	-	-		$V_{CE}=1V, I_C=500mA$
$f_T$	100	-	-	MHz	$V_{CE}=5V, I_C=10mA, f=100MHz$
Cob	-	5	-	pF	$V_{CB}=10V, I_E=0A, f=1MHz$

\*Pulse Test: Pulse Width  $\leq 380\mu s$ , Duty Cycle  $\leq 2\%$

**Classification of hFE 1:**

Rank	16	25	40
Range	100--250	160--400	250--600



### Characteristic Curves

Current Gain vs Collector Current

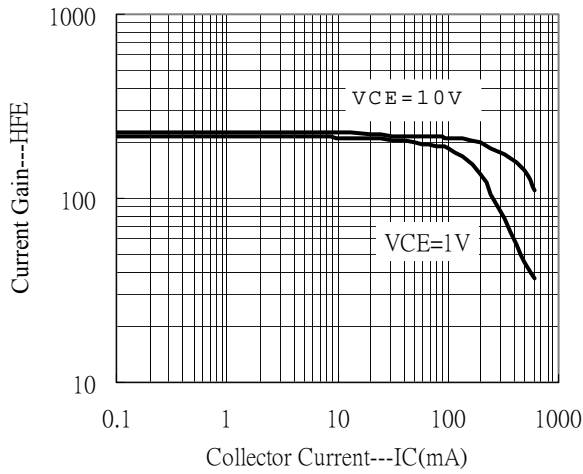

Saturation Voltage vs Collector Current

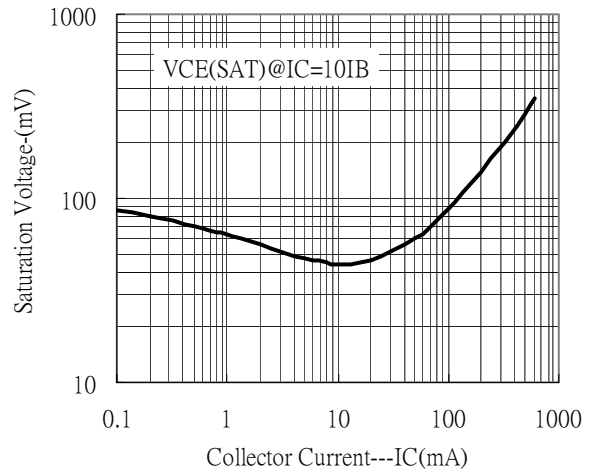

Saturation Voltage vs Collector Current

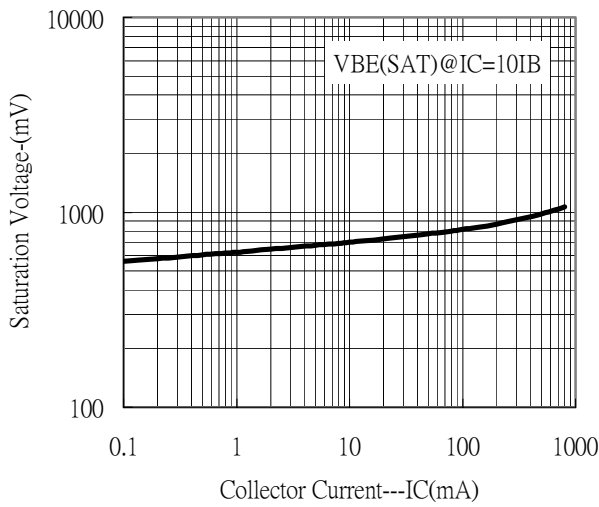

Power Derating Curve

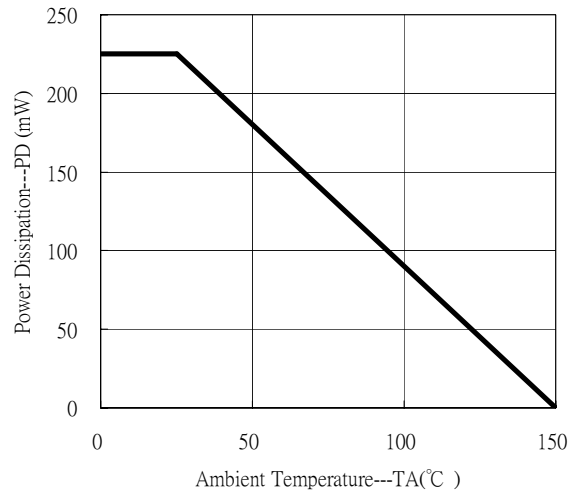

**SOT-23 Dimension**

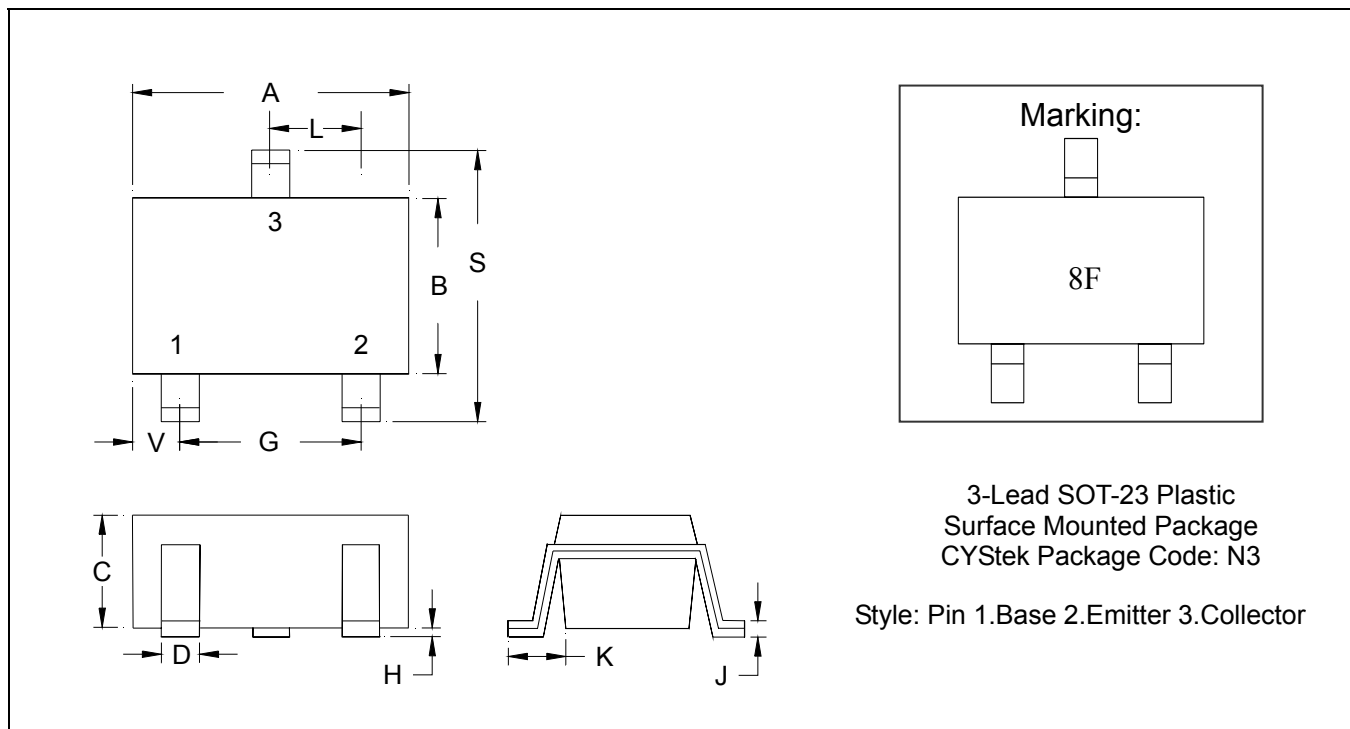

3-Lead SOT-23 Plastic  
 Surface Mounted Package  
 CYStek Package Code: N3  
 Style: Pin 1.Base 2.Emitter 3.Collector

\*: Typical

DIM	Inches		Millimeters		DIM	Inches		Millimeters	
	Min.	Max.	Min.	Max.		Min.	Max.	Min.	Max.
A	0.1102	0.1204	2.80	3.04	J	0.0034	0.0070	0.085	0.177
B	0.0472	0.0630	1.20	1.60	K	0.0128	0.0266	0.32	0.67
C	0.0335	0.0512	0.89	1.30	L	0.0335	0.0453	0.85	1.15
D	0.0118	0.0197	0.30	0.50	S	0.0830	0.1083	2.10	2.75
G	0.0669	0.0910	1.70	2.30	V	0.0098	0.0256	0.25	0.65
H	0.0005	0.0040	0.013	0.10					

Notes: 1.Controlling dimension: millimeters.  
 2.Maximum lead thickness includes lead finish thickness, and minimum lead thickness is the minimum thickness of base material.  
 3.If there is any question with packing specification or packing method, please contact your local CYStek sales office.

**Material:**

- Lead: 42 Alloy ; solder plating
- Mold Compound: Epoxy resin family, flammability solid burning class: UL94V-0

**Important Notice:**

- All rights are reserved. Reproduction in whole or in part is prohibited without the prior written approval of CYStek.
- CYStek reserves the right to make changes to its products without notice.
- CYStek **semiconductor products are not warranted to be suitable for use in Life-Support Applications, or systems.**
- CYStek assumes no liability for any consequence of customer product design, infringement of patents, or application assistance.