

### PNP Silicon AF Transistor

- For general AF applications
- High collector current
- High current gain
- Low collector-emitter saturation voltage
- Complementary types: BC817W, BC818W (NPN)

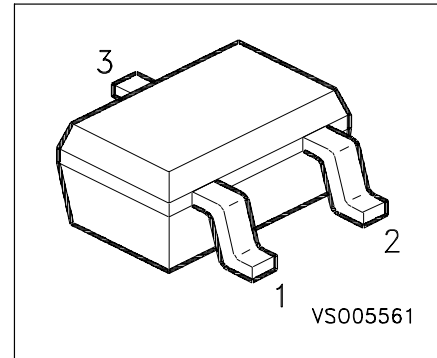

Type	Marking	Ordering Code	Pin Configuration			Package
BC 807-16W	5As	Q62702-C2325	1 = B	2 = E	3 = C	SOT-323
BC 807-25W	5Bs	Q62702-C2326	1 = B	2 = E	3 = C	SOT-323
BC 807-40W	5Cs	Q62702-C2327	1 = B	2 = E	3 = C	SOT-323
BC 808-16W	5Es	Q62702-C2328	1 = B	2 = E	3 = C	SOT-323
BC 808-25W	5Fs	Q62702-C2329	1 = B	2 = E	3 = C	SOT-323
BC 808-40W	5Gs	Q62702-C2330	1 = B	2 = E	3 = C	SOT-323

### Maximum Ratings

Parameter	Symbol	Values	Unit
Collector-emitter voltage	$V_{CEO}$		V
BC 807 W		45	
BC 808 W		25	
Collector-base voltage	$V_{CBO}$		
BC 807 W		50	
BC 808 W		30	
Emitter-base voltage	$V_{EBO}$	5	
DC collector current	$I_C$	500	mA
Peak collector current	$I_{CM}$	1	A
Base current	$I_B$	100	mA
Total power dissipation, $T_S = 130^\circ\text{C}$	$P_{tot}$	250	mW
Junction temperature	$T_j$	150	$^\circ\text{C}$
Storage temperature	$T_{stg}$	- 65 ... + 150	

### Thermal Resistance

Junction ambient <sup>1)</sup>	$R_{thJA}$	$\leq 215$	K/W
Junction - soldering point	$R_{thJS}$	$\leq 80$	

1) Package mounted on pcb 40mm x 40mm x 1.5mm / 0.5cm<sup>2</sup> Cu

### Electrical Characteristics at $T_A=25^\circ\text{C}$ , unless otherwise specified

Parameter	Symbol	Values			Unit
		min.	typ.	max.	
<b>DC Characteristics</b>					
Collector-emitter breakdown voltage $I_C = 10\text{ mA}$ , $I_B = 0$ , BC 807 W $I_C = 10\text{ mA}$ , $I_B = 0$ , BC 808 W	$V_{(BR)CEO}$	45 25	- -	- -	V
Collector-base breakdown voltage $I_C = 10\text{ }\mu\text{A}$ , $I_B = 0$ , BC 807 W $I_C = 10\text{ }\mu\text{A}$ , $I_B = 0$ , BC 808 W	$V_{(BR)CBO}$	50 30	- -	- -	
Base-emitter breakdown voltage $I_E = 10\text{ }\mu\text{A}$ , $I_C = 0$	$V_{(BR)EBO}$	5	-	-	
Collector-base cutoff current $V_{CB} = 25\text{ V}$ , $T_A = 25\text{ }^\circ\text{C}$ $V_{CB} = 25\text{ V}$ , $T_A = 150\text{ }^\circ\text{C}$	$I_{CBO}$	- -	- -	100 50	nA $\mu\text{A}$
Emitter cutoff current $V_{EB} = 4\text{ V}$ , $I_C = 0$	$I_{EBO}$	-	-	100	nA
DC current gain $I_C = 100\text{ mA}$ , $V_{CE} = 1\text{ V}$ , BC ... 16 W $I_C = 100\text{ mA}$ , $V_{CE} = 1\text{ V}$ , BC ... 25 W $I_C = 100\text{ mA}$ , $V_{CE} = 1\text{ V}$ , BC ... 40 W $I_C = 300\text{ mA}$ , $V_{CE} = 1\text{ V}$ , BC ... 16 W $I_C = 300\text{ mA}$ , $V_{CE} = 1\text{ V}$ , BC ... 25 W $I_C = 300\text{ mA}$ , $V_{CE} = 1\text{ V}$ , BC ... 40 W	$h_{FE}$	100 160 250 60 100 170	160 250 350 - - -	250 400 630 - - -	-
Collector-emitter saturation voltage 1) $I_C = 500\text{ mA}$ , $I_B = 50\text{ mA}$	$V_{CEsat}$	-	-	0.7	V
Base-emitter saturation voltage 1) $I_C = 500\text{ mA}$ , $I_B = 50\text{ mA}$	$V_{BEsat}$	-	-	1.2	

1) Pulse test:  $t < 300\mu\text{s}$ ;  $D < 2\%$

**PNP Silicon AF Transistor**
**Electrical Characteristics** at  $T_A=25^\circ\text{C}$ , unless otherwise specified

Parameter	Symbol	Values			Unit
		min.	typ.	max.	

**AC Characteristics**

Transition frequency $I_C = 50 \text{ mA}$ , $V_{CE} = 5 \text{ V}$ , $f = 100 \text{ MHz}$	$f_T$	-	200	-	MHz
Collector-base capacitance $V_{CB} = 10 \text{ V}$ , $f = 1 \text{ MHz}$	$C_{cb}$	-	10	-	pF
Emitter-base capacitance $V_{EB} = 0.5 \text{ V}$ , $f = 1 \text{ MHz}$	$C_{eb}$	-	60	-	

**Total power dissipation**  $P_{tot} = f(T_A^*; T_S)$

\* Package mounted on epoxy

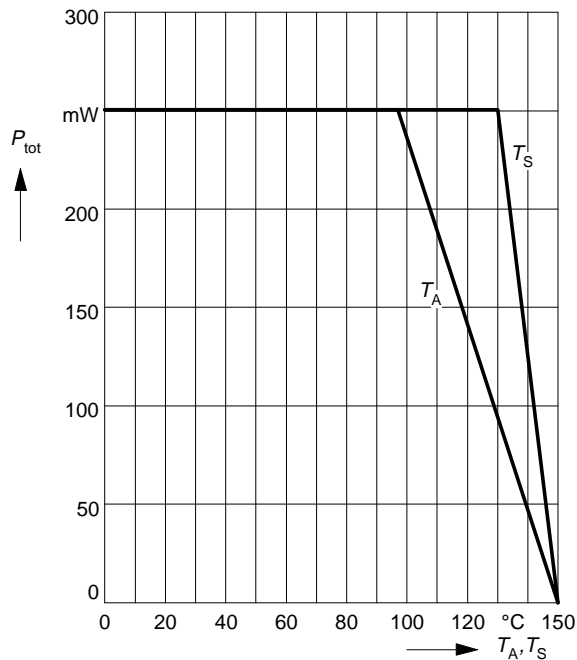

**Permissible Pulse Load**  $R_{thJS} = f(t_p)$

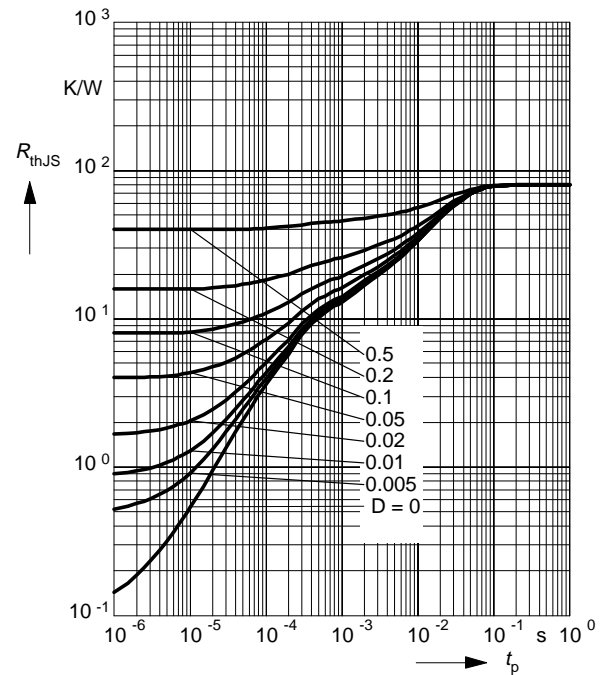

**Permissible Pulse Load**  $P_{totmax} / P_{totDC} = f(t_p)$

**Collector cutoff current**  $I_{CBO} = f(T_A)$

$V_{CB} = 60V$

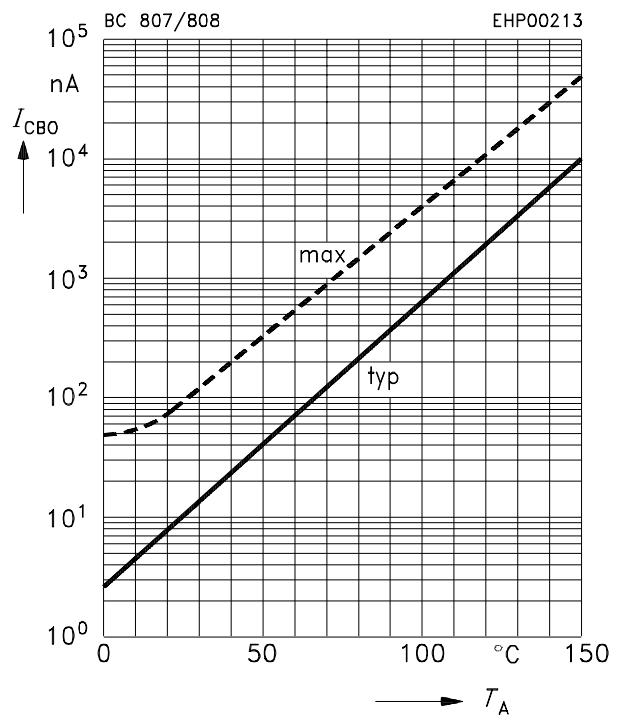
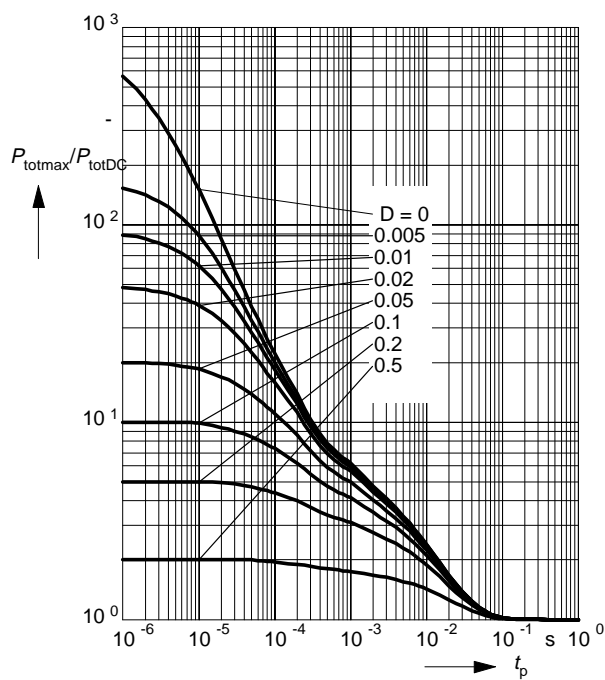

### DC current gain $h_{FE} = f(I_C)$

$V_{CE} = 1V$

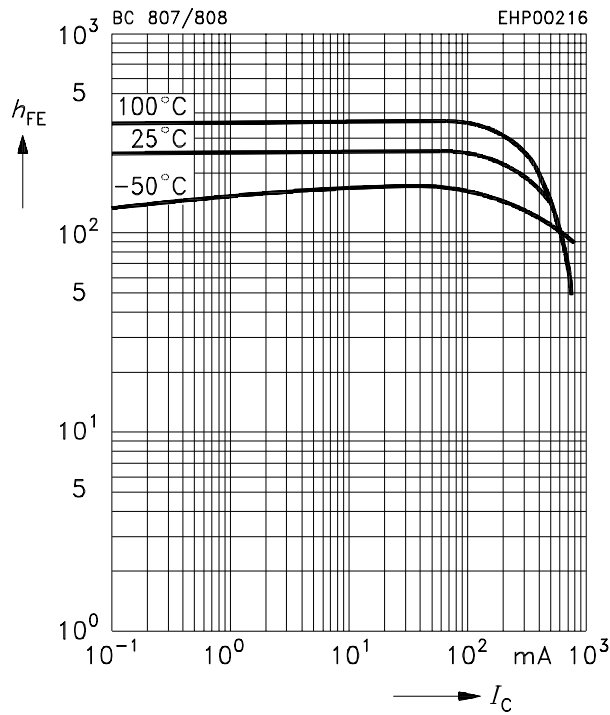

### Transition frequency $f_T = f(I_C)$

$V_{CE} = 5V$

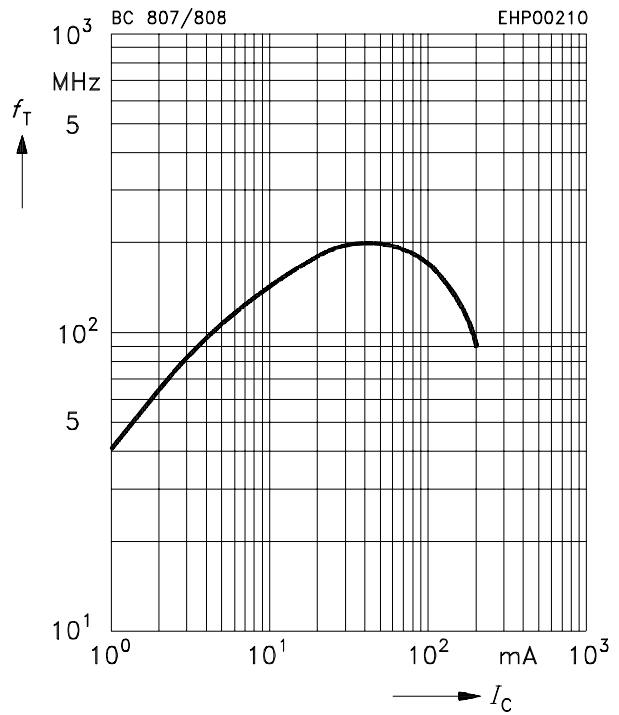

### Base-emitter saturation voltage

$I_C = f(V_{BEsat}), h_{FE} = 10$

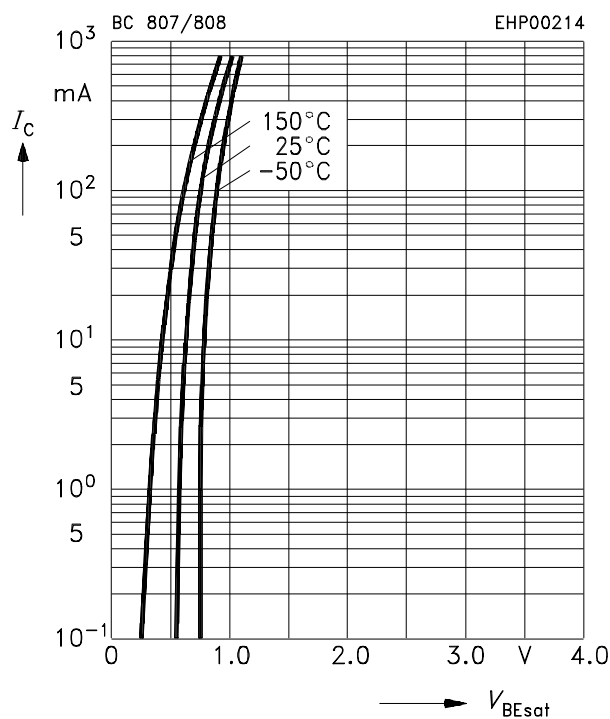

### Collector-emitter saturation voltage

$I_C = f(V_{CEsat}), h_{FE} = 10$

