

JRC SAW FILTER

NSVA352

Application

1575.42MHz GPS

Electrical Specification: (Table 1)

The device characteristics are measured in the circuit shown in Fig.1.

Table 1. Electrical Specifications

Item	Spec.	
Input and Output Impedance	50Ω	
Nominal Center Frequency (f0)	1575.42MHz	
Insertion Loss	1574.42~1576.42MHz	3.5dB max.
Response Variation	1574.42~1576.42MHz	1.5dB max.
Input and Output VSWR	1574.42~1576.42MHz	2.5 max.
Out of Band Rejection (Relative to Through Level)	1475.42MHz	40dB min.
	1535.42MHz	30dB min.
	1615.42MHz	20dB min.
	1675.42MHz	40dB min.

(Operating Temperature Range: -40~+85°C)

Maximum Rating: (Table 2)

Table 2. Maximum Ratings

Item	Rating
Maximum Input Power	+20dBm
Maximum DC Voltage	7.5V
Operating Temperature Range	-40~+85°C
Storage Temperature	-50~+100°C

Mechanical Specifications: (Fig.2)

Package is designed as small as 3.5x3.5x1.0[mm³] for SMD (Surface Mount Device) type.

Notice:

This part is electrostatic discharge sensitive and may be damaged by improper handling.

Communications Equipment Division
Communications Equipment Marketing Department

Japan Radio Co., Ltd.

17-22 Akasaka 2-chome minato-ku,

Tokyo. 107-0052 Japan

Tel. +81 3-3584-8811

Fax. +81 3-3584-8876

http://www.jrc.co.jp/product/comm/deveice/saw/saw_top.html (Japanese)

http://www.jrc.co.jp/product/comm/device/saw/saw_top_e.html (English)

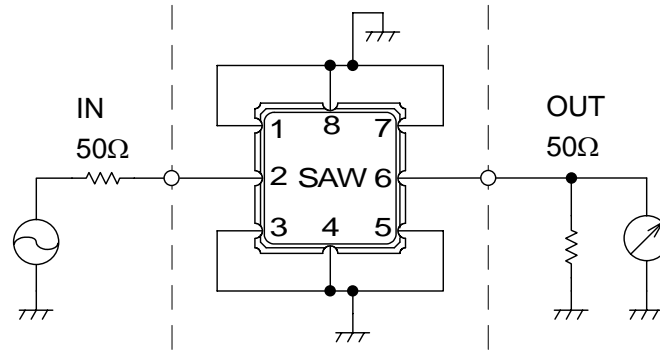
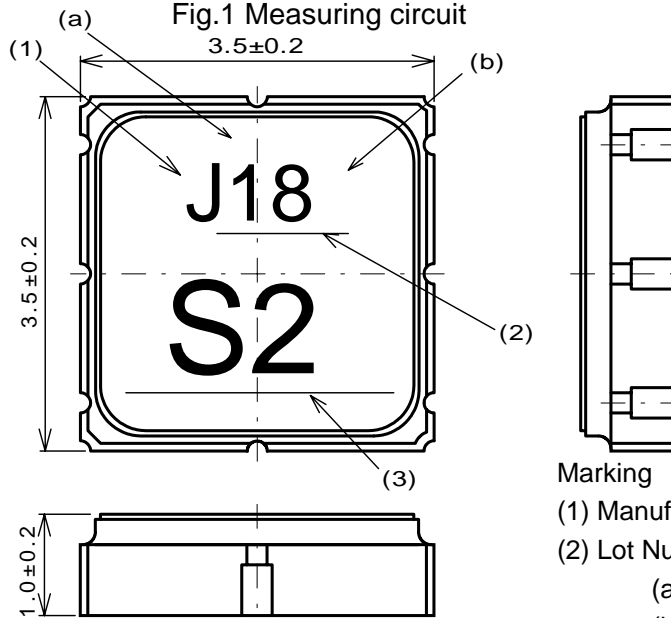

Fig.1 Measuring circuit



Marking

(1) Manufacturer's Mark

(2) Lot Number

(a) Year

(b) Month

*Oct.--- X

Nov.--- Y

Dec.--- Z

(3) Part number Mark

Pin no.	Connection
1	GND
2	IN/OUT
3	GND
4	GND
5	GND
6	OUT/IN
7	GND
8	GND

Fig.2 Package dimensions (in mm)

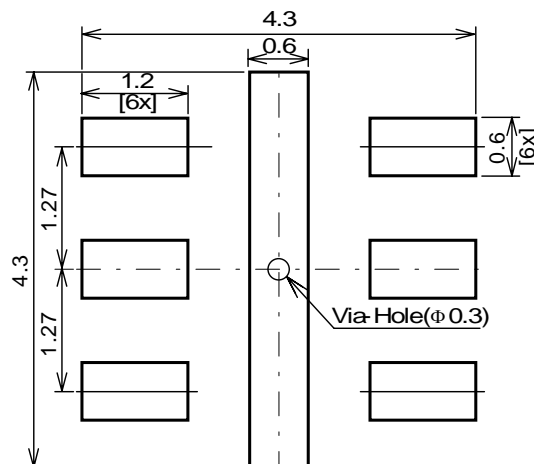

Fig.3 Desirable land area (in mm)

Notice

1. Use this component within operating temperature range. It might not be satisfied with electrical specification without operating temperature range. When it is used less than -40°C or more than $+85^{\circ}\text{C}$, it might be a cause of degradation or destruction of the component. Even if it endures during a short time, it causes degradation of qualification.
2. When soldering iron is used, solder with the temperature at the tip of soldering iron: 350°C max., the time of soldering: 10 seconds max., the power of soldering iron: 30W max..
3. Notice that the allowed time of soldering with soldering iron is accumulated time, when soldering is repeated.
4. As rapid temperature change for cleaning after reflow soldering might be a cause of destruction clean this component after confirming that temperature of this component goes down to room temperature.
5. Confirm that there are not any influence for qualification to this component in mounting on PCB when this component is cleaned.
6. As it might be a cause of degradation or destruction to apply static electricity to this component, do not apply static electricity or excessive voltage while assembling and measuring. And do not transport this component with bare hand.
7. As it might be a cause of degradation or destruction to apply D.C. voltage between each terminal, apply D.C. voltage 7.5V max. in actual circuit.

Note

1. This specification specifies the quality of this component as a single unit. Make sure that this component is evaluated and confirmed against this specification when it is mounted to your products.

CH1 S₂₁ log MAG 1 dB/ REF 0 dB 1: -2.6179 dB
 CH2 S₂₁ log MAG 10 dB/ REF 0 dB 1: -2.6179 dB

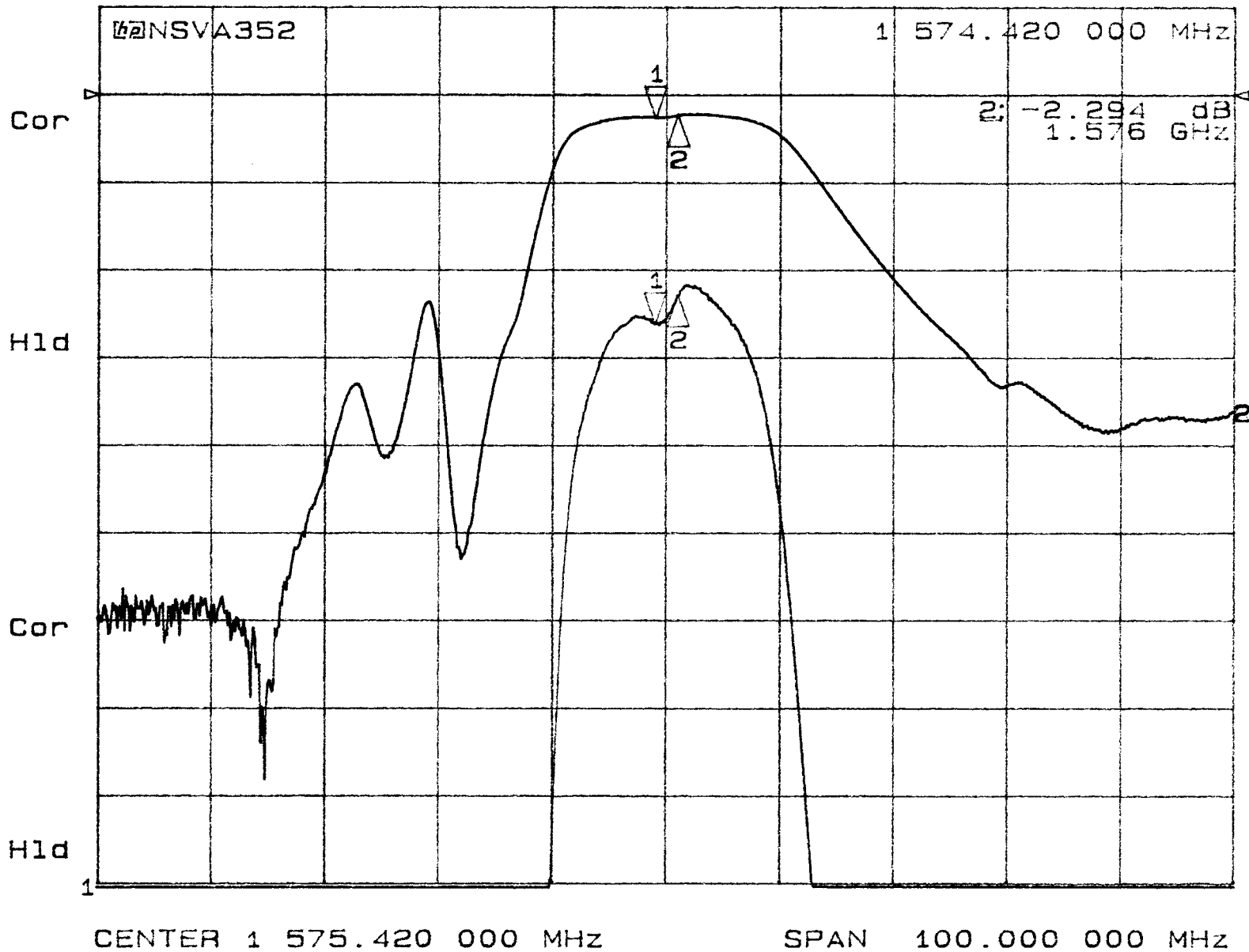

CH1 S₁₁ 1 U FS 1: 60.152 Ω 1.0254 Ω 103.65 pF
 SENSVA352 1 574.420 000 MHz

Cor

H1d

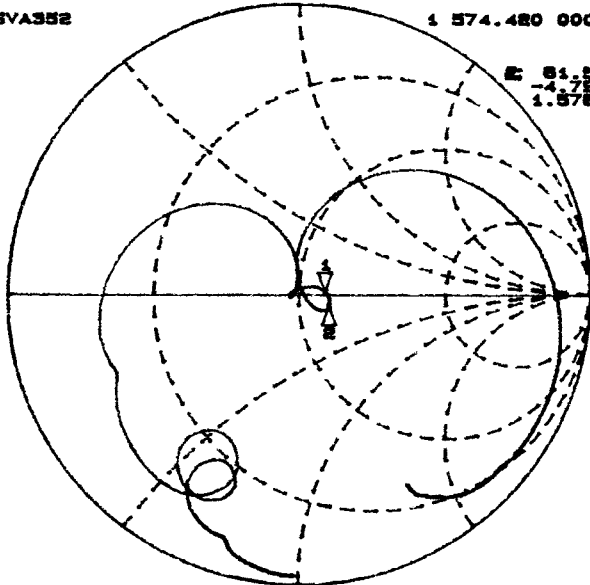

CENTER 1 575.420 000 MHz SPAN 100.000 000 MHz

CH1 S₁₁ SWR 1 / REF 1 1: 1.2042

Cor

H1d

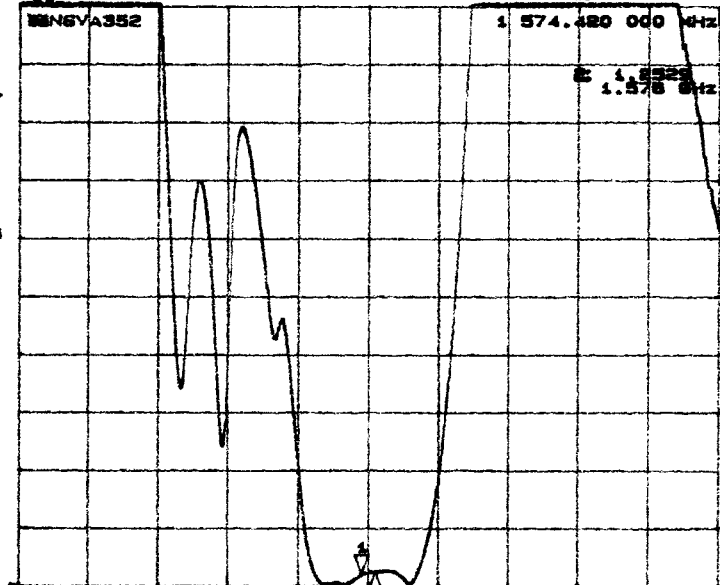

CENTER 1 575.420 000 MHz SPAN 100.000 000 MHz

CH1 S₂₂ 1 U FS 1: 63.166 Ω -3.9063 Ω 25.678 pF
 SENSVA352 1 574.420 000 MHz

Cor

H1d

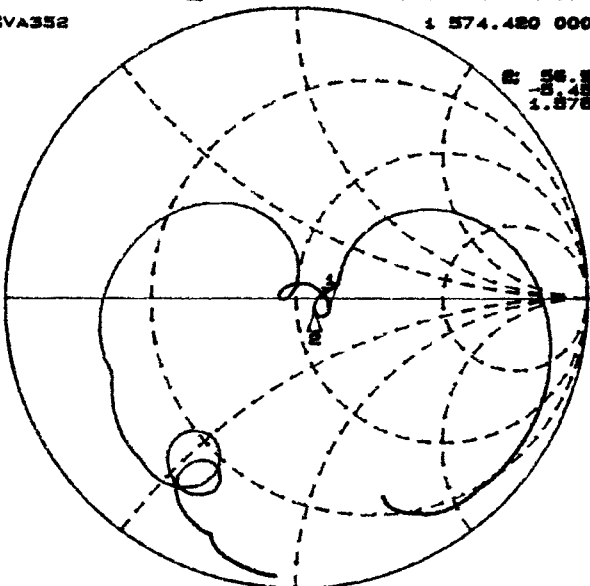

CENTER 1 575.420 000 MHz SPAN 100.000 000 MHz

CH1 S₂₂ SWR 1 / REF 1 1: 1.2781

Cor

H1d

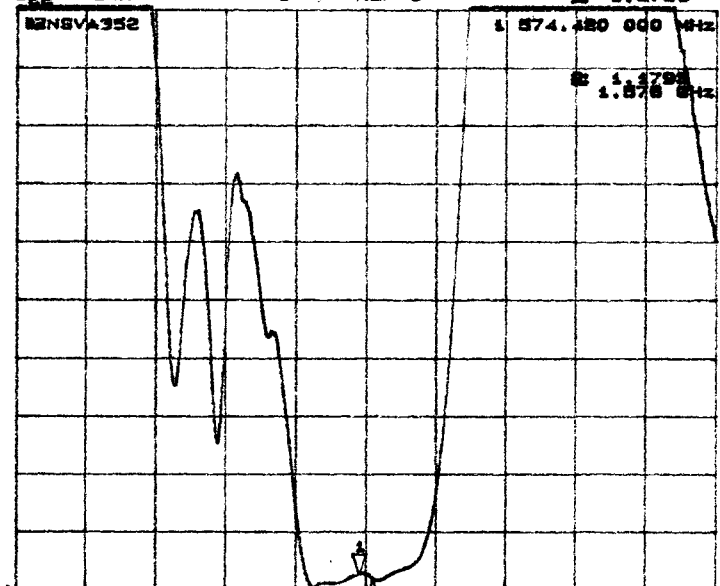

CENTER 1 575.420 000 MHz SPAN 100.000 000 MHz

CH1 S₂₁ log MAG 10 dB/ REF 0 dB

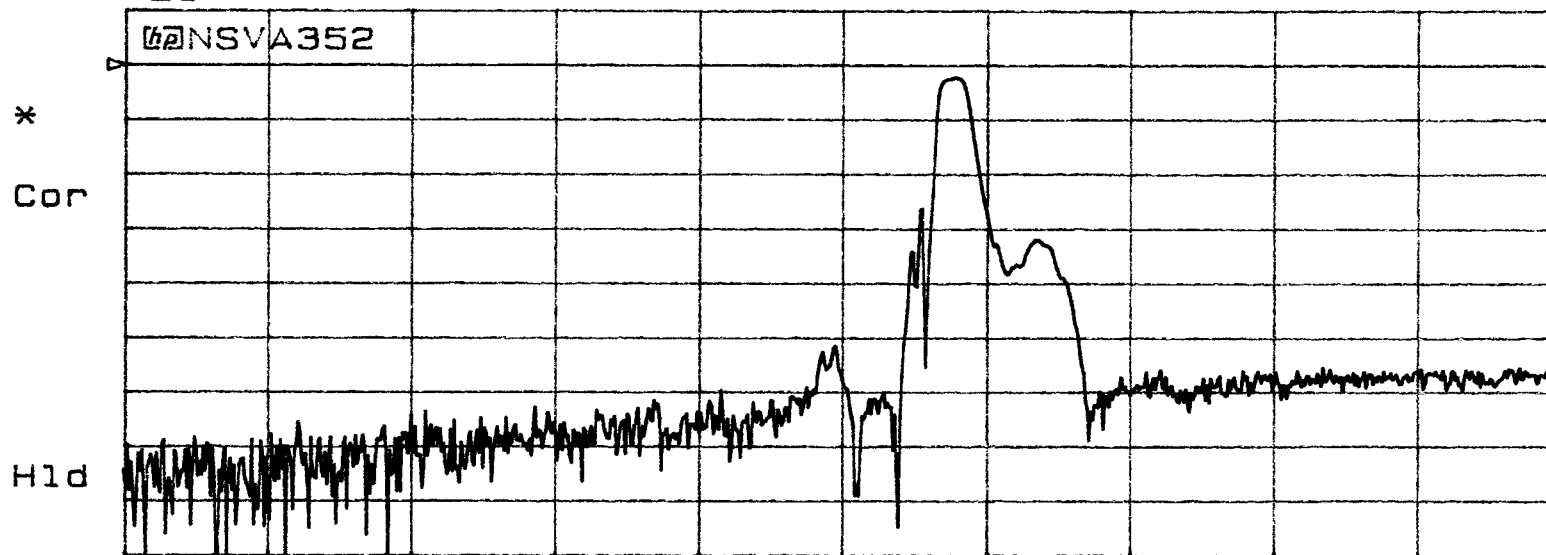

CH1 START 1 000.000 000 MHz STOP 2 000.000 000 MHz

CH2 S₂₁ log MAG 10 dB/ REF 0 dB

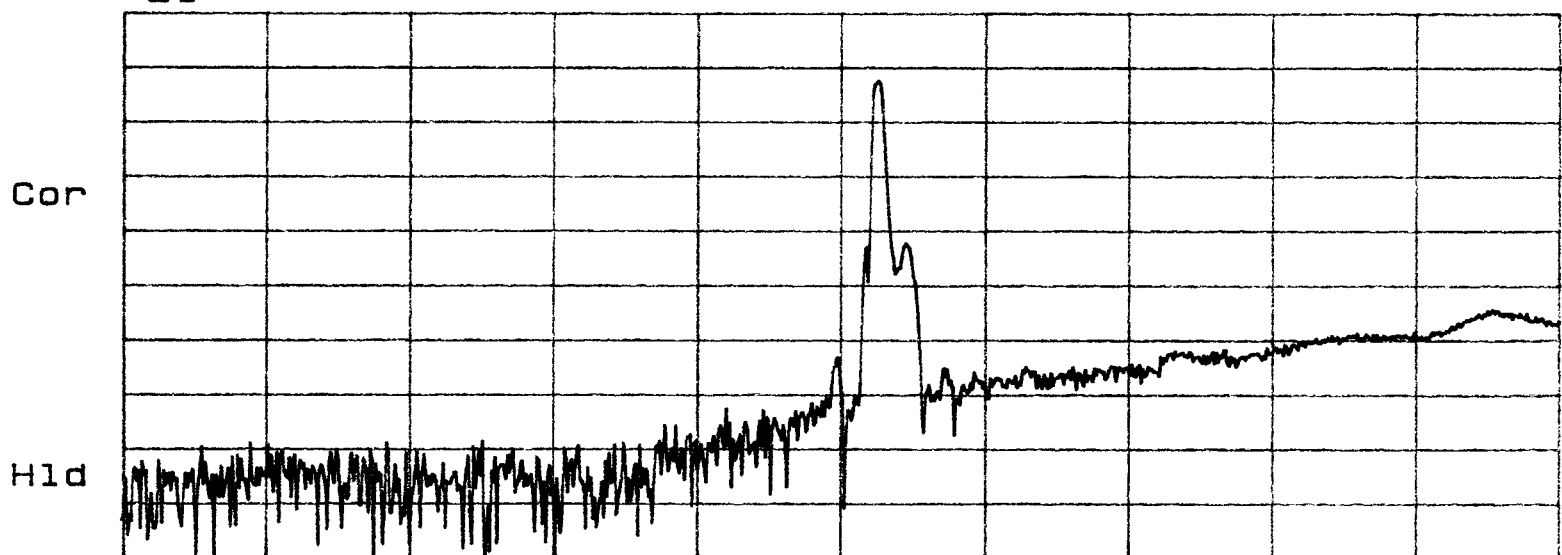

CH2 START .300 000 MHz STOP 3 000.000 000 MHz

CH1 S₂₁ delay 50 ns/ REF 0 s 1: 40.405 ns

