

JRC SAW FILTER

NSVS676

Application

463MHz Low-Loss Type

Electrical Specification: (Table 1)

The device characteristics are measured in the circuit shown in Fig.1.

Table 1. Electrical Specifications

Item		Spec.	Typical
Input and Output Impedance		-	50Ω
Nominal Center Frequency (f0)		-	463MHz
Insertion Loss	453~473MHz	4.0dB max.	2.8dB
Response Variation	453~473MHz	2.0dB max.	0.9dB
Input and Output VSWR	453~473MHz	2.5 max.	1.5
Out of Band Rejection (Relative to Through Level)	423MHz	40dB min.	45dB
	553MHz	40dB min.	45dB

(Operating Temperature Range: -10+60°C)

Maximum Rating: (Table 2)

Table 2. Maximum Ratings

Item	Rating
Maximum Input Power	+20dBm
Maximum DC Voltage	7.5V
Operating Temperature Range	-10~+60°C
Storage Temperature	-30~+85°C

Mechanical Specifications: (Fig.2)

Package is designed as small as 5.2x4.5x1.5[mm³] for SMD (Surface Mount Device) type.

Notice:

This part is electrostatic discharge sensitive and may be damaged by improper handling.

Communications Equipment Division
Communications Equipment Marketing Department

Japan Radio Co., Ltd.

17-22 Akasaka 2-chome minato-ku,

Tokyo. 107-0052 Japan

Tel. +81 3-3584-8811

Fax. +81 3-3584-8876

http://www.jrc.co.jp/product/comm/device/saw/saw_top.html (Japanese)

http://www.jrc.co.jp/product/comm/device/saw/saw_top_e.html (English)

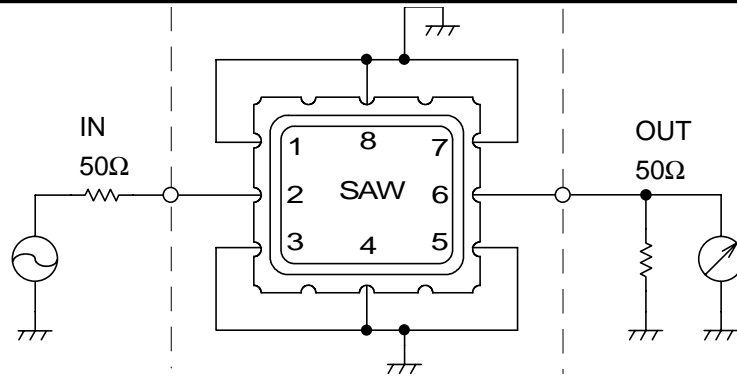
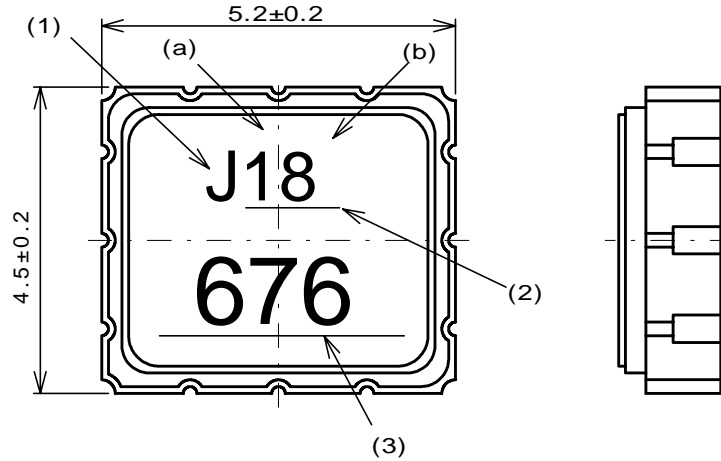

Fig.1 Measuring circuit



Marking

- (1) Manufacturer's Mark
- (2) Lot Number
 - (a) Year
 - (b) Month

*Oct.--- X
 Nov.--- Y
 Dec.--- Z

- (3) Part number Mark

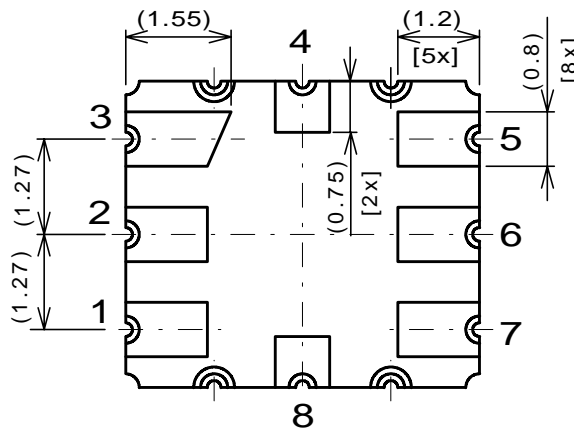

Fig.2 Package dimensions (in mm)

Pin no.	Connection
1	GND
2	IN/OUT
3	GND
4	GND
5	GND
6	OUT/IN
7	GND
8	GND

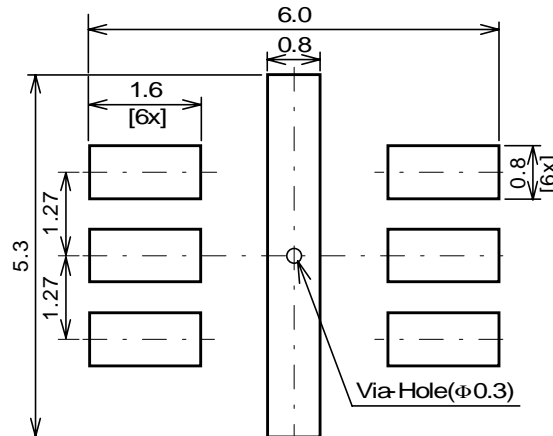

Fig.3 Desirable land area (in mm)

Notice

1. Use this component within operating temperature range. It might not be satisfied with electrical specification without operating temperature range. When it is used less than -10°C or more than +60°C, it might be a cause of degradation or destruction of the component. Even if it endures during a short time, it causes degradation of qualification.
2. When soldering iron is used, solder with the temperature at the tip of soldering iron: 350°C max., the time of soldering: 10 seconds max., the power of soldering iron: 30W max..
3. Notice that the allowed time of soldering with soldering iron is accumulated time, when soldering is repeated.
4. As rapid temperature change for cleaning after reflow soldering might be a cause of destruction clean this component after confirming that temperature of this component goes down to room temperature.
5. Confirm that there are not any influence for qualification to this component in mounting on PCB when this component is cleaned.
6. As it might be a cause of degradation or destruction to apply static electricity to this component, do not apply static electricity or excessive voltage while assembling and measuring. And do not transport this component with bare hand.
7. As it might be a cause of degradation or destruction to apply D.C. voltage between each terminal, apply D.C. voltage 7.5V max. in actual circuit.

Note

1. This specification specifies the quality of this component as a single unit. Make sure that this component is evaluated and confirmed against this specification when it is mounted to your products.

463MHz Low-LossType
FREQUENCY CHARACTERISTICS

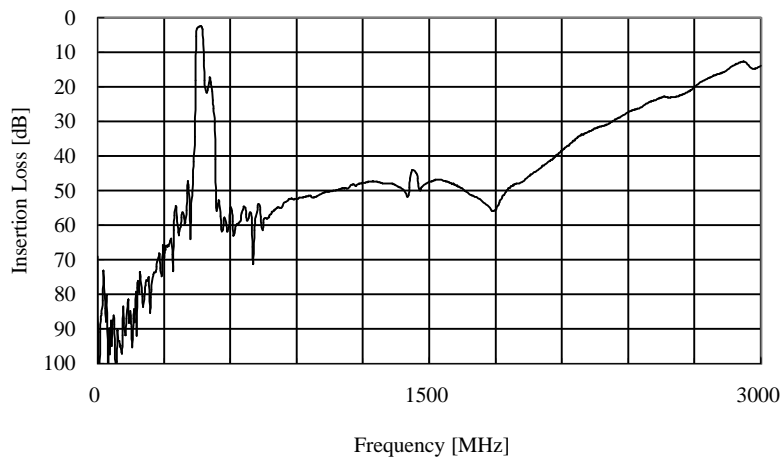
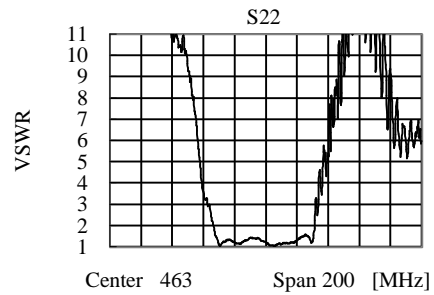
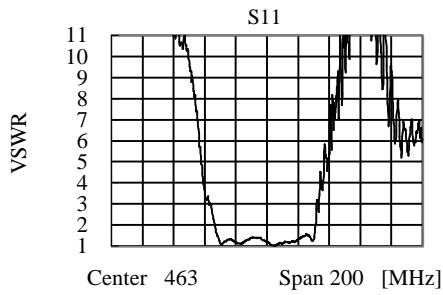
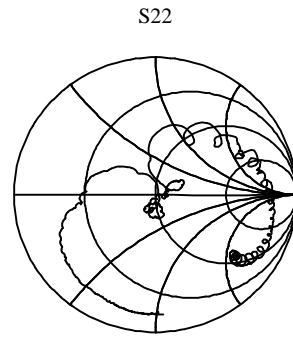
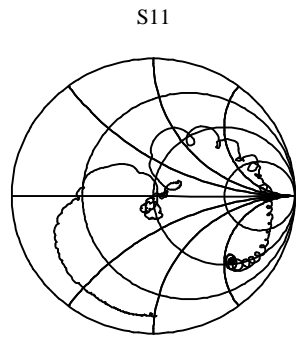
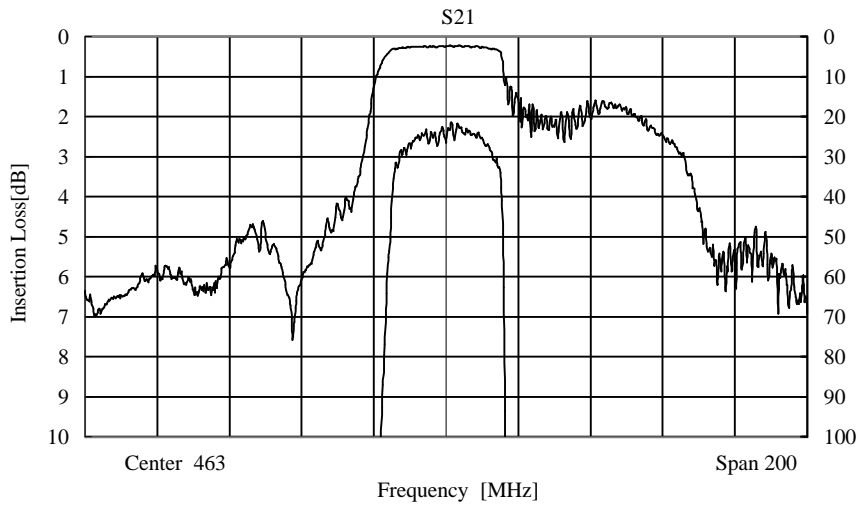

Japan Radio Co., Ltd.