

# FMM5823X

## K-Band Power Amplifier MMIC

### FEATURES

- High Output Power: P1dB = 27~29 dBm (Typ.)
- High Linear Gain: GL = 19 dB(Typ.)
- Frequency Band: 17.7 - 27.0 GHz
- High Linearity: OIP3 = 36.5dBm(typ.)
- Impedance Matched Zin/Zout = 50Ω

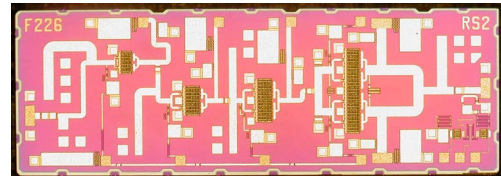

### DESCRIPTION

The FMM5823X is a power amplifier MMIC that contains a four stage amplifier, internally matched, for standard communications band in 17.7 to 27.0GHz frequency range. This product is well suited for point-to-point radio applications.

Eudyna's stringent Quality Assurance Program assures the highest reliability and consistent performance.

### ABSOLUTE MAXIMUM RATING

Item	Symbol	Rating	Unit
Drain-Source Voltage	VDD	10	V
Gate-Source Voltage	VGG	-3	V
Input Power	Pin	22	dBm
Storage Temperature	Tstg	-55 to +125	°C

### RECOMMENDED OPERATING CONDITIONS

Item	Symbol	Condition	Unit
Drain-Source Voltage	VDD	≤7	V
Input Power	Pin	14	dBm
Operating Backside Temperature	Top	-40 to +85	°C

This product should be hermetically packaged.

### ELECTRICAL CHARACTERISTICS (Ambient Temperature Ta=25°C)

Item	Symbol	Test Conditions	Limits			Unit
			Min.	Typ.	Max.	
Frequency Range	f	VDD=6.0V	17.7	-	19.7	GHz
Output Power at 1dB G.C.P.	P1dB	IDD(DC)=700mA typ.	25.0	27.0	-	dBm
Power Gain at 1dB G.C.P.	G1dB	Zs=Zl=50ohm	16	18	-	dB
Power Added Efficiency at 1dB G.C.P.	Nadd		-	12	-	%
Third Order Intermodulation	IM3*	*df=10MHz, Po=19dBm	-32	-35	-	dBc
Drain Current at 1dB G.C.P.	Iddrf	(S.C.L.)	-	700	1200	mA
Input Return Loss at Pin=-20dBm	RLin		-	-7	-	dB
Output Return Loss at Pin=-20dBm	RLout		-	-8	-	dB
Frequency Range	f	VDD=6.0V	21.2	-	27	GHz
Output Power at 1dB G.C.P.	P1dB	IDD(DC)=700mA typ.	27.0	29.0	-	dBm
Power Gain at 1dB G.C.P.	G1dB	Zs=Zl=50ohm	16	18	-	dB
Power Added Efficiency at 1dB G.C.P.	Nadd		-	15	-	%
Third Order Intermodulation	IM3**	**df=10MHz, Po=19dBm	-32	-35	-	dBc
Drain Current at 1dB G.C.P.	Iddrf	(S.C.L.)	-	900	1500	mA
Input Return Loss at Pin=-20dBm	RLin		-	-7	-	dB
Output Return Loss at Pin=-20dBm	RLout		-	-10	-	dB

Note : RF parameter sample size 10ps. Criteria (accept/reject)=(0/1)

G.C.P. : Gain Compression Point

S.C.L. : Single Carrier Level

<b>ESD</b>	<b>Class 0</b>	<b>~ 199V</b>
------------	----------------	---------------

Note : Based on EIAJ ED-4701 C-111A(C=100pF, R=1.5kΩ)

# FMM5823X

## K-Band Power Amplifier MMIC

### Output Power vs. Frequency

VDD=6V, IDD(DC)=700mA

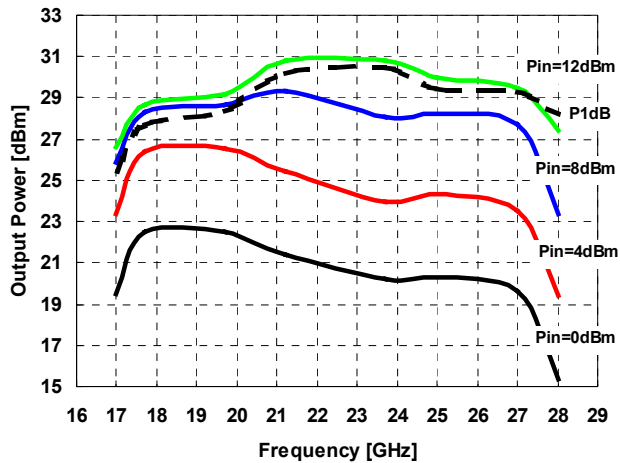

### Output Power, Drain Current vs. Input Power

VDD=6V, IDD(DC)=700mA

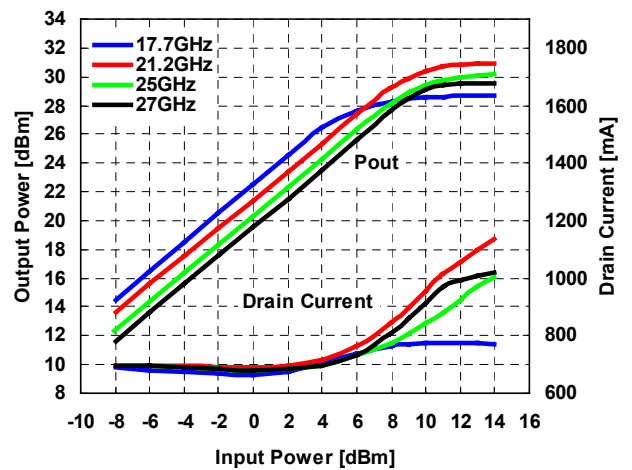

### Power Added Efficiency vs. Frequency

VDD=6V, IDD(DC)=700mA

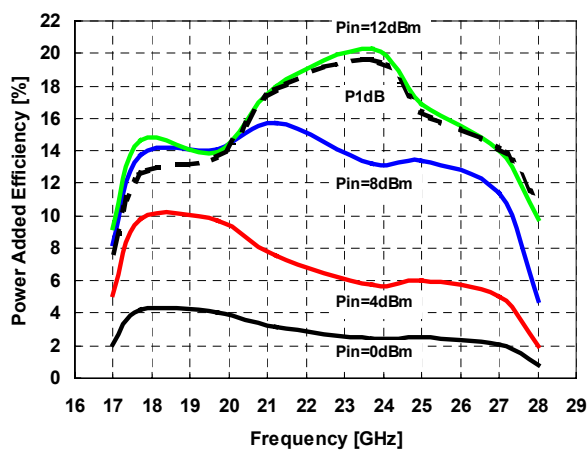

# FMM5823X

## K-Band Power Amplifier MMIC

IMD vs. Frequency

VDD=6V, IDD(DC)=700mA, Pout=19dBm S.C.L.

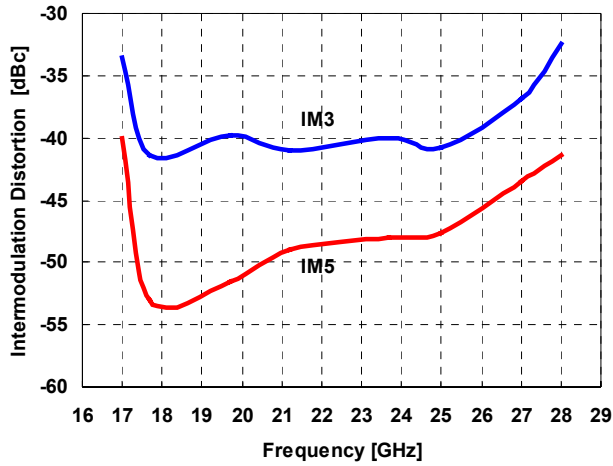

IMD vs. Output Power

VDD=6V, IDD(DC)=700mA

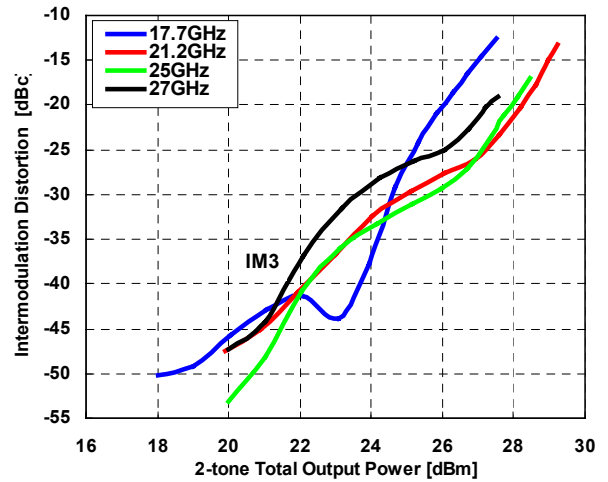

Output Power, Gain vs. Drain Voltage

IDD(DC)=700mA

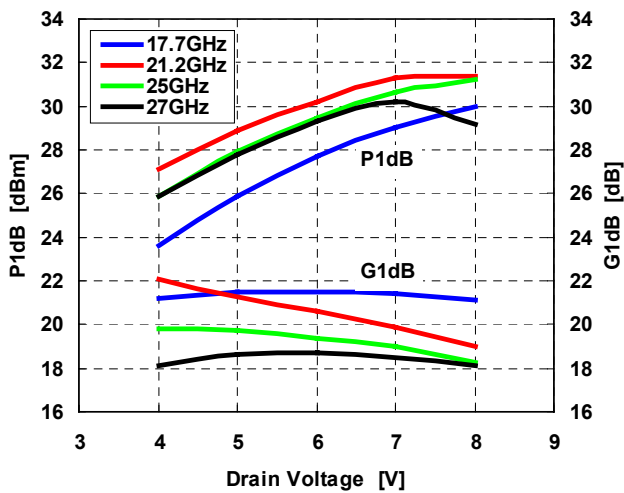

Output Power, Gain vs. Drain Current

VDD=6V

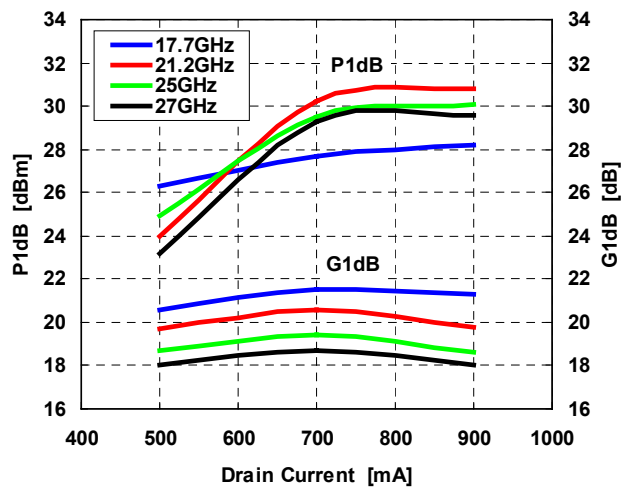

# FMM5823X

## K-Band Power Amplifier MMIC

Output Power, Drain Current vs. Input Power by Drain Voltage

IDD(DC)=700mA, f=17.7GHz

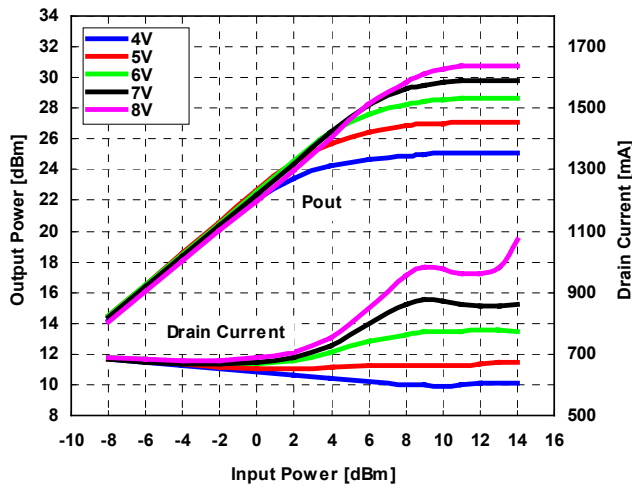

Output Power, Drain Current vs. Input Power by Drain Voltage

IDD(DC)=700mA, f=21.2GHz

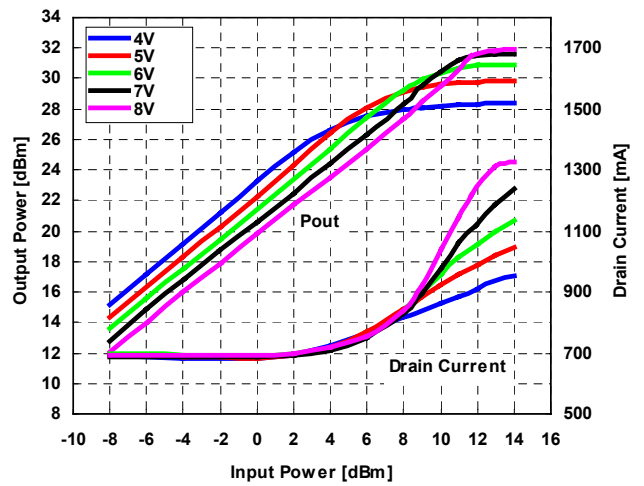

Output Power, Drain Current vs. Input Power by Drain Voltage

IDD(DC)=700mA, f=25GHz

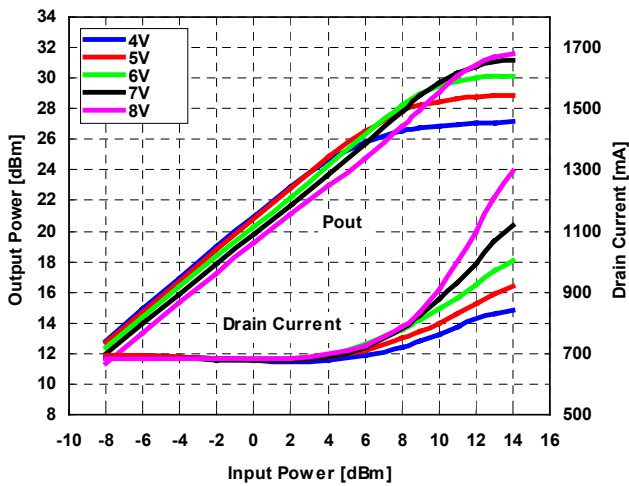

Output Power, Drain Current vs. Input Power by Drain Voltage

IDD(DC)=700mA, f=27GHz

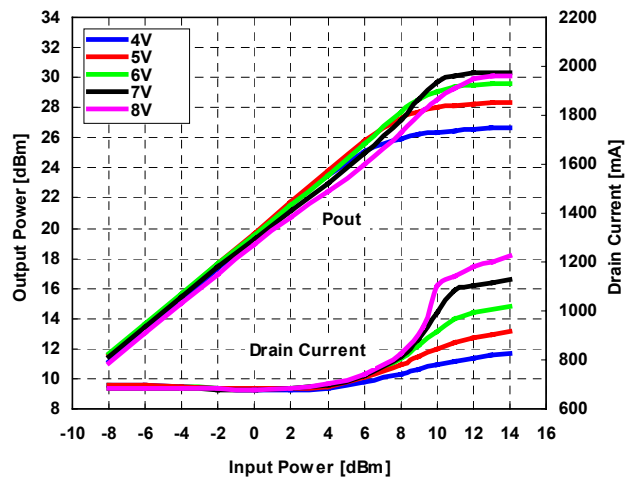

# FMM5823X

## K-Band Power Amplifier MMIC

Output Power, Drain Current  
vs. Input Power by Drain Current

VDD=6V, f=17.7GHz

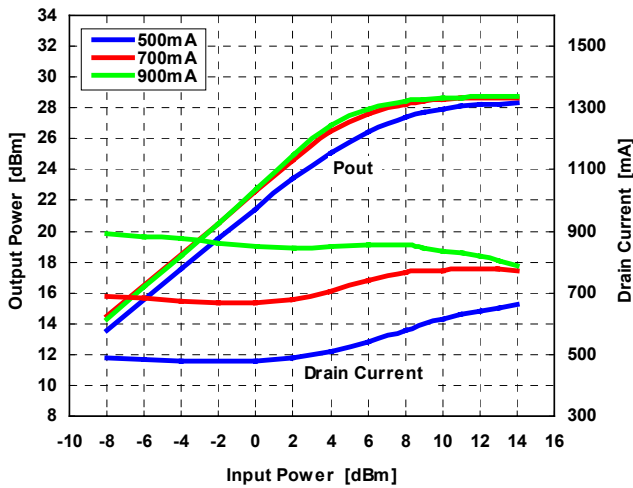

Output Power, Drain Current  
vs. Input Power by Drain Current

VDD=6V, f=21.2GHz

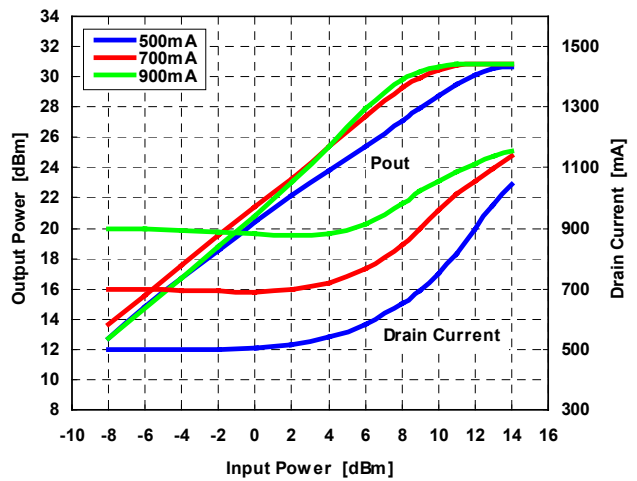

Output Power, Drain Current  
vs. Input Power by Drain Current

VDD=6V, f=25GHz

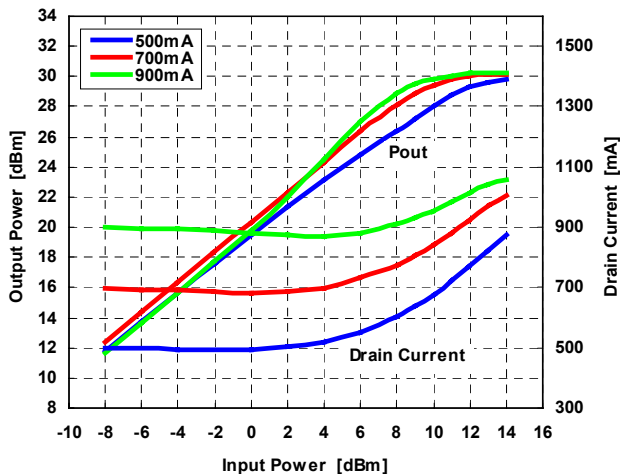

Output Power, Drain Current  
vs. Input Power by Drain Current

VDD=6V, f=27GHz

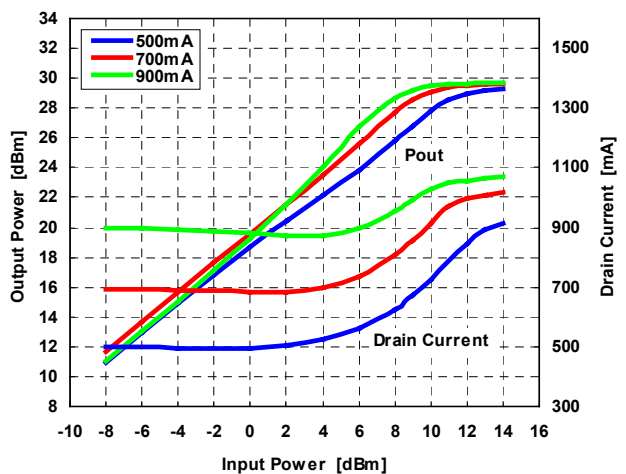

# FMM5823X

## K-Band Power Amplifier MMIC

IMD vs. Output Power  
by Drain Voltage

IDD(DC)=700mA, f=17.7GHz

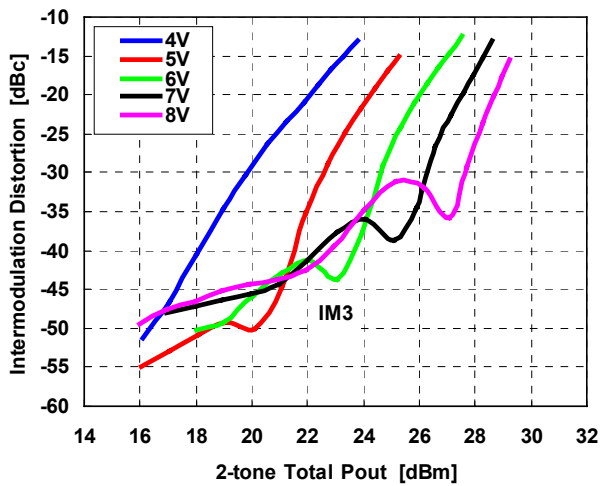

IMD vs. Output Power  
by Drain Voltage

IDD(DC)=700mA, f=21.2GHz

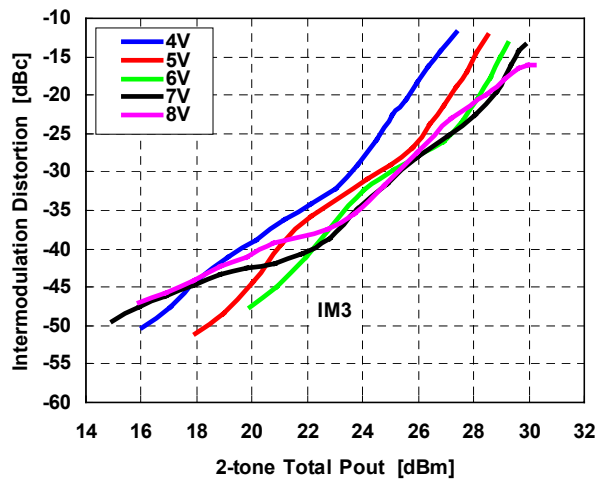

IMD vs. Output Power  
by Drain Voltage

IDD(DC)=700mA, f=25GHz

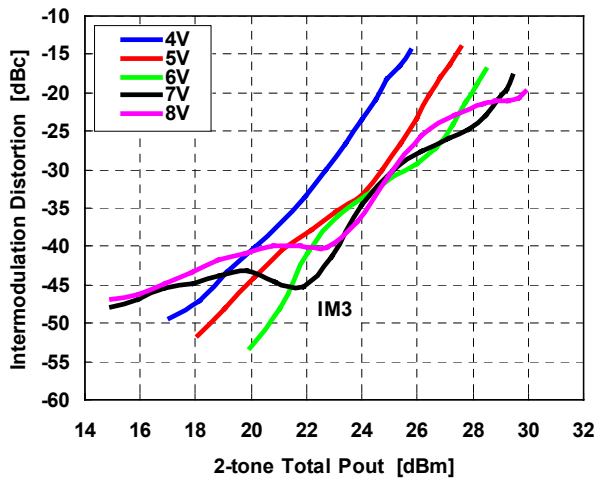

IMD vs. Output Power  
by Drain Voltage

IDD(DC)=700mA, f=27GHz

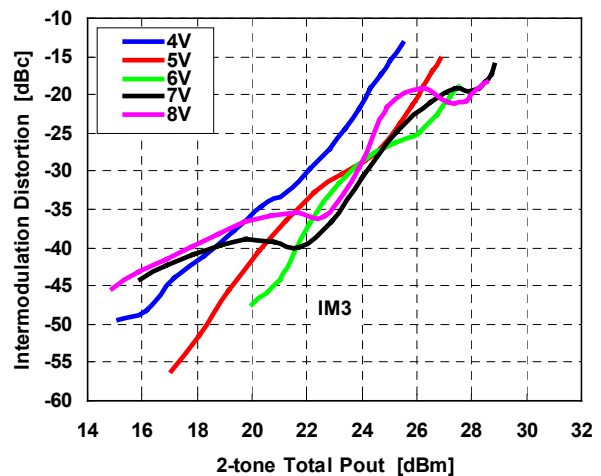

---

---

---

# FMM5823X

## K-Band Power Amplifier MMIC

IMD vs. Output Power  
by Drain Current

VDD=6V, f=17.7GHz

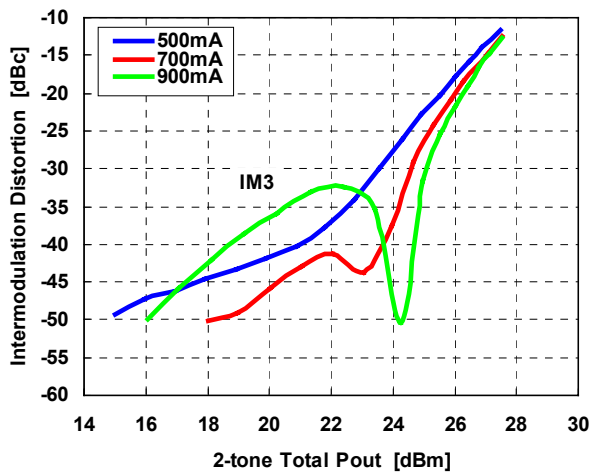

IMD vs. Output Power  
by Drain Current

VDD=6V, f=21.2GHz

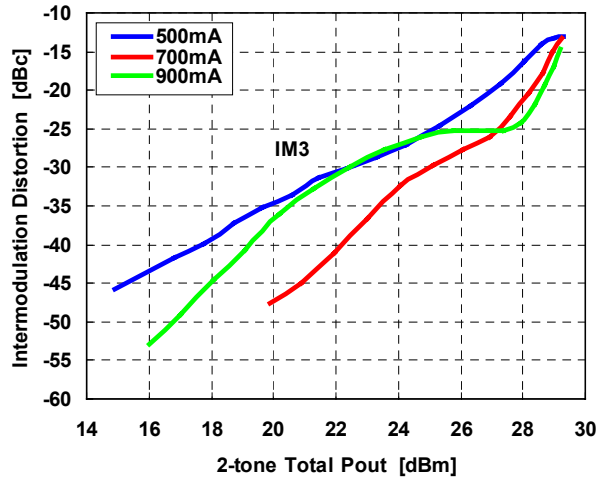

IMD vs. Output Power  
by Drain Current

VDD=6V, f=25GHz

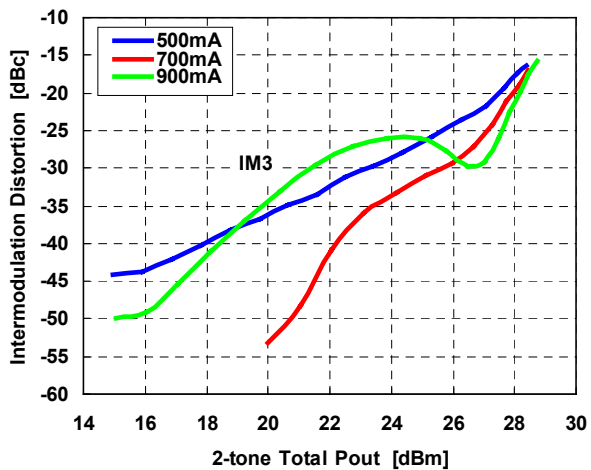

IMD vs. Output Power  
by Drain Current

VDD=6V, f=27GHz

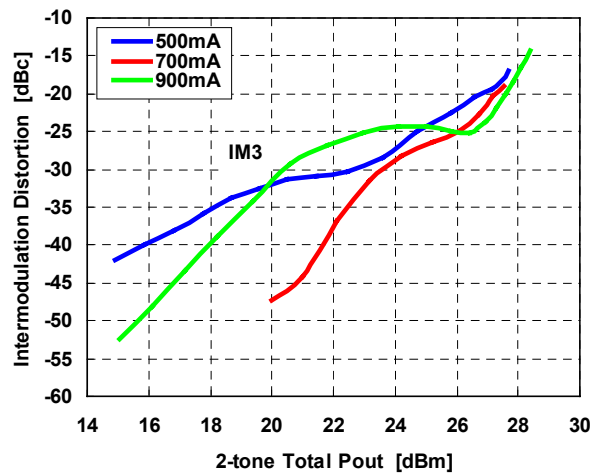

# FMM5823X

## K-Band Power Amplifier MMIC

### TUNING PERFORMANCE

FMM5823X can be improved lower band performance by wire-bonding on MMIC chip.

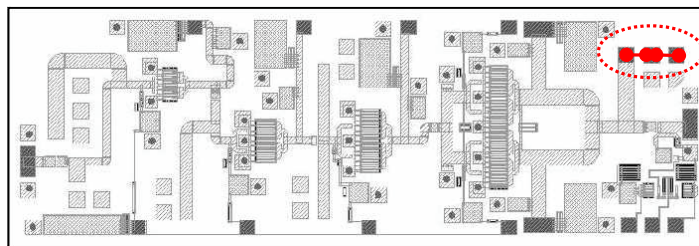

Tuning Position

#### Output Power vs. Frequency

VDD=6V, IDD(DC)=700mA, with-Tuning

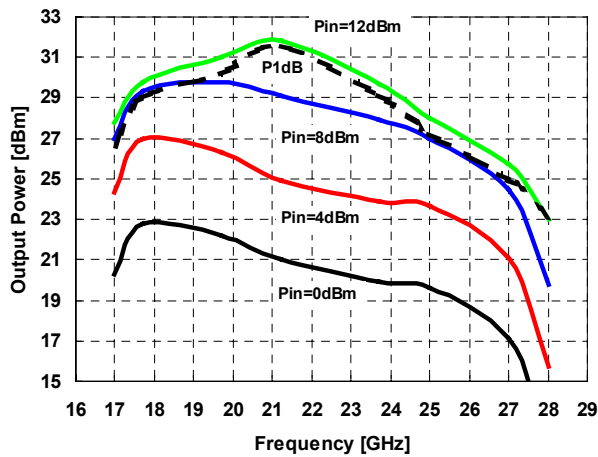

#### IMD vs. Output Power

VDD=6V, IDD(DC)=700mA, with-Tuning

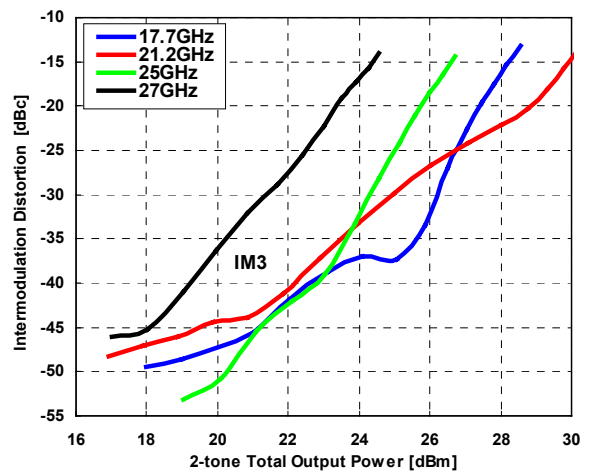



---

---

---

# FMM5823X

K-Band Power Amplifier MMIC

## ■ S-PARAMETER

@VDD=6V, IDD=700mA

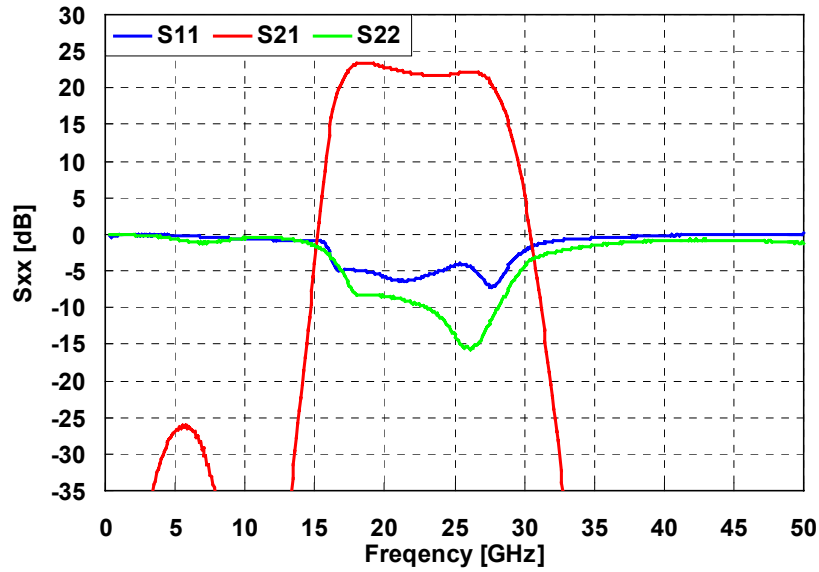

@VDD=6V, IDD=700mA

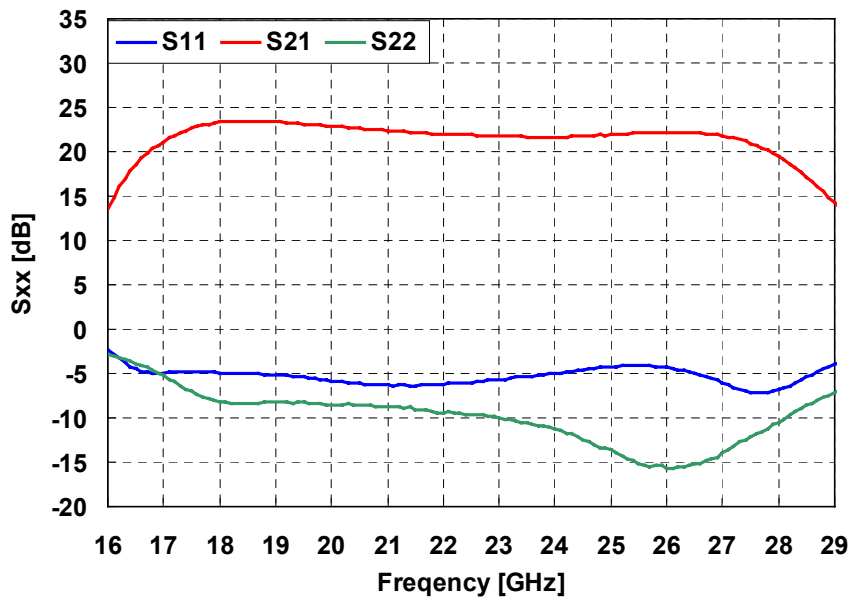

# FMM5823X

## K-Band Power Amplifier MMIC

### ■ S-PARAMETER

@VDD=6V, IDD=700mA

Frequency [GHz]	S11		S21		S12		S22		Frequency [GHz]	S11		S21		S12		S22	
	Mag	Ang	Mag	Ang	Mag	Ang	Mag	Ang		Mag	Ang	Mag	Ang	Mag	Ang	Mag	Ang
1.0	0.99	-14.89	0.01	120.39	0.0001	-24.51	0.99	-31.61	25.2	0.62	-92.87	12.56	-165.09	0.0014	53.53	0.19	66.92
2.0	0.99	-28.80	0.01	-35.01	0.0001	-20.61	0.99	-60.61	25.4	0.63	-100.40	12.67	179.93	0.0017	-16.31	0.18	58.31
3.0	0.99	-42.81	0.01	-136.89	0.0001	-116.82	0.98	-83.84	25.6	0.62	-107.94	12.70	165.03	0.0011	47.68	0.17	50.35
4.0	0.99	-56.16	0.03	119.67	0.0001	83.19	0.95	-104.08	25.8	0.62	-115.84	12.77	149.62	0.0009	6.78	0.17	42.17
5.0	0.98	-69.22	0.05	22.00	0.0002	38.40	0.93	-119.04	26.0	0.61	-124.47	12.79	134.08	0.0007	-32.21	0.17	30.69
6.0	0.98	-81.91	0.05	-65.62	0.0001	-68.77	0.89	-130.59	26.2	0.59	-133.52	12.83	117.98	0.0006	67.94	0.17	19.14
7.0	0.96	-93.46	0.03	-148.65	0.0000	-10.30	0.88	-138.69	26.4	0.58	-144.20	12.81	101.33	0.0006	10.84	0.17	10.91
8.0	0.95	-104.22	0.01	141.72	0.0002	-135.47	0.89	-145.43	26.6	0.55	-155.39	12.72	84.19	0.0011	-68.05	0.18	0.06
9.0	0.94	-114.42	0.00	105.72	0.0003	-146.04	0.92	-153.48	26.8	0.53	-168.60	12.54	66.62	0.0010	30.33	0.18	-8.37
10.0	0.93	-124.79	0.00	151.63	0.0004	-146.06	0.94	-161.52	27.0	0.50	176.92	12.29	48.60	0.0005	-13.77	0.20	-14.64
11.0	0.93	-135.00	0.00	-155.34	0.0007	140.78	0.95	-170.05	28.0	0.45	81.72	9.37	-47.86	0.0002	19.37	0.30	-46.15
12.0	0.92	-145.63	0.00	-0.28	0.0006	132.62	0.95	-178.90	29.0	0.63	8.95	5.15	-147.70	0.0014	65.92	0.44	-65.59
13.0	0.91	-156.86	0.01	29.34	0.0007	83.44	0.93	171.82	30.0	0.77	-28.92	1.85	112.99	0.0024	-31.00	0.61	-85.92
14.0	0.91	-169.48	0.08	18.06	0.0009	69.99	0.90	161.87	31.0	0.86	-51.81	0.42	33.39	0.0012	-77.14	0.71	-105.06
15.0	0.91	173.95	0.63	-27.32	0.0009	11.68	0.84	150.68	32.0	0.89	-67.39	0.08	-22.65	0.0013	164.14	0.76	-118.37
16.0	0.77	147.12	4.75	-124.06	0.0005	-70.94	0.73	138.43	33.0	0.92	-78.92	0.01	-49.31	0.0006	-154.17	0.79	-128.63
17.0	0.57	145.60	11.41	104.34	0.0004	-124.07	0.55	128.21	34.0	0.93	-87.89	0.00	60.73	0.0014	-72.50	0.82	-137.00
17.6	0.57	138.71	13.82	36.89	0.0004	-179.59	0.43	130.09	35.0	0.94	-95.09	0.01	4.98	0.0010	76.56	0.84	-144.78
17.8	0.57	135.34	14.31	15.89	0.0005	-150.78	0.41	132.36	36.0	0.95	-101.06	0.00	-11.36	0.0003	-44.58	0.86	-150.87
18.0	0.57	132.14	14.68	-4.55	0.0006	-121.06	0.39	135.70	37.0	0.95	-106.85	0.00	-32.17	0.0007	109.01	0.87	-157.63
18.2	0.57	128.11	14.86	-24.36	0.0006	137.19	0.38	138.23	38.0	0.96	-111.46	0.00	-54.54	0.0009	150.06	0.89	-163.05
18.4	0.56	123.95	14.87	-43.04	0.0005	175.38	0.38	140.47	39.0	0.97	-115.56	0.00	-124.10	0.0008	70.69	0.89	-169.09
18.6	0.56	119.48	14.93	-61.37	0.0008	142.55	0.38	141.92	40.0	0.98	-119.44	0.00	-38.24	0.0006	-29.58	0.91	-174.46
18.8	0.56	114.55	14.88	-79.11	0.0008	146.79	0.39	142.82	41.0	0.99	-123.57	0.00	-54.25	0.0017	11.94	0.91	179.80
19.0	0.55	109.29	14.77	-96.03	0.0007	46.06	0.39	142.87	42.0	0.99	-126.88	0.00	125.84	0.0011	-130.60	0.91	174.11
19.2	0.55	103.58	14.58	-112.64	0.0007	98.08	0.39	142.53	43.0	0.99	-130.10	0.00	-123.75	0.0008	-123.02	0.91	168.69
19.4	0.54	97.46	14.37	-128.45	0.0010	79.04	0.38	142.66	44.0	0.99	-133.53	0.00	-125.78	0.0011	-57.23	0.92	162.96
19.6	0.53	91.69	14.22	-143.85	0.0003	-66.43	0.38	141.81	45.0	0.99	-136.46	0.00	-62.92	0.0012	-117.37	0.91	156.61
19.8	0.52	85.09	14.06	-159.26	0.0012	81.95	0.38	141.51	46.0	0.99	-139.06	0.00	148.78	0.0010	-47.81	0.91	150.46
20.0	0.51	78.45	13.85	-173.97	0.0012	-152.89	0.38	141.88	47.0	0.99	-142.33	0.00	36.80	0.0011	1.62	0.90	143.76
20.2	0.50	72.00	13.76	171.54	0.0006	125.81	0.37	141.06	48.0	0.99	-145.09	0.01	92.45	0.0012	45.14	0.89	136.62
20.4	0.50	65.01	13.59	157.09	0.0005	66.98	0.37	140.49	49.0	0.99	-147.79	0.01	143.09	0.0006	-70.26	0.88	129.61
20.6	0.49	57.96	13.46	142.88	0.0008	31.23	0.37	140.33	50.0	0.99	-167.68	0.00	173.49	0.0016	-164.23	0.87	120.93
20.8	0.49	50.49	13.31	128.92	0.0005	14.65	0.37	139.43									
21.0	0.48	43.17	13.12	115.45	0.0007	97.87	0.37	138.36									
21.2	0.48	36.08	13.01	101.92	0.0006	10.28	0.36	137.88									
21.4	0.48	28.64	12.90	88.18	0.0001	-75.66	0.36	135.98									
21.6	0.48	21.49	12.77	74.87	0.0010	129.71	0.35	134.13									
21.8	0.49	14.15	12.66	61.77	0.0004	-19.85	0.35	132.70									
22.0	0.49	7.08	12.57	48.62	0.0005	-151.98	0.34	132.29									
22.2	0.50	-0.27	12.59	35.35	0.0009	176.30	0.34	130.29									
22.4	0.50	-7.81	12.46	22.01	0.0011	97.15	0.33	129.02									
22.6	0.50	-14.02	12.38	8.99	0.0008	154.43	0.33	126.66									
22.8	0.51	-20.69	12.32	-4.17	0.0012	100.80	0.32	124.52									
23.0	0.52	-26.94	12.26	-17.27	0.0003	161.09	0.31	121.83									
23.2	0.53	-33.23	12.24	-30.17	0.0002	-42.29	0.31	118.88									
23.4	0.54	-39.57	12.21	-43.52	0.0019	119.96	0.30	115.17									
23.6	0.54	-45.35	12.15	-56.53	0.0004	38.82	0.29	111.49									
23.8	0.55	-51.03	12.14	-69.76	0.0011	80.63	0.29	108.23									
24.0	0.56	-56.68	12.09	-82.88	0.0012	113.39	0.27	103.21									
24.2	0.57	-61.71	12.10	-95.92	0.0015	49.10	0.26	98.37									
24.4	0.58	-67.71	12.19	-109.46	0.0009	70.06	0.25	92.23									
24.6	0.59	-73.01	12.23	-122.86	0.0023	43.01	0.23	86.73									
24.8	0.61	-79.81	12.41	-136.65	0.0013	-18.87	0.21	81.93									
25.0	0.62	-86.39	12.48	-150.90	0.0010	85.71	0.21	75.12									

---

---

---

# FMM5823X

K-Band Power Amplifier MMIC

$\Delta T_{ch}$  vs. Drain Voltage  
(Reference)

IDD(DC)=700mA

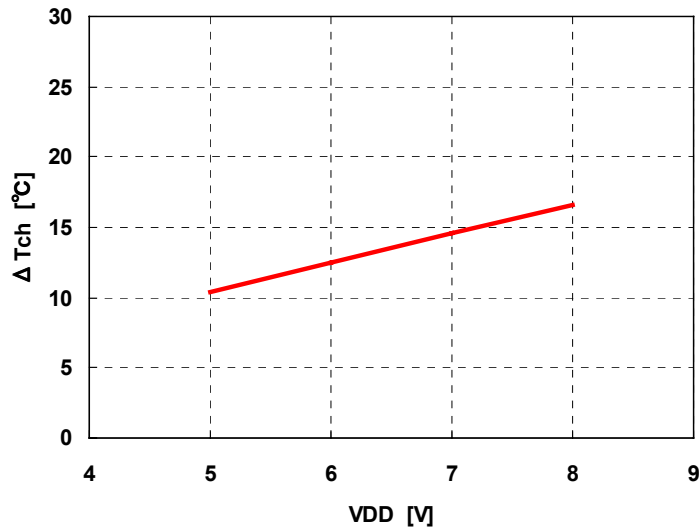

MTTF vs.  $T_{ch}$

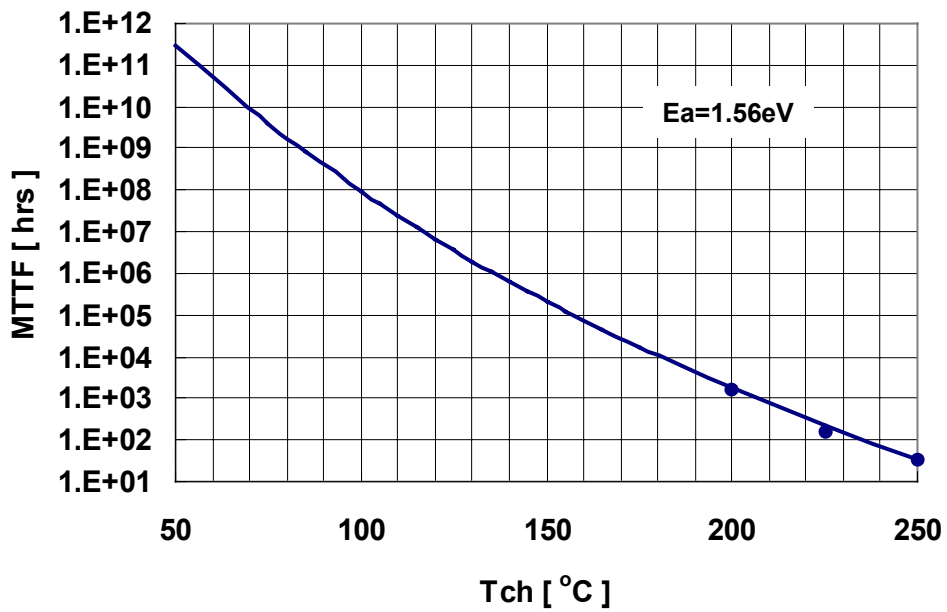

# FMM5823X

## K-Band Power Amplifier MMIC

### ■ Chip Outline and Bonding Pad Locations (Dimension in Micro-Meters)

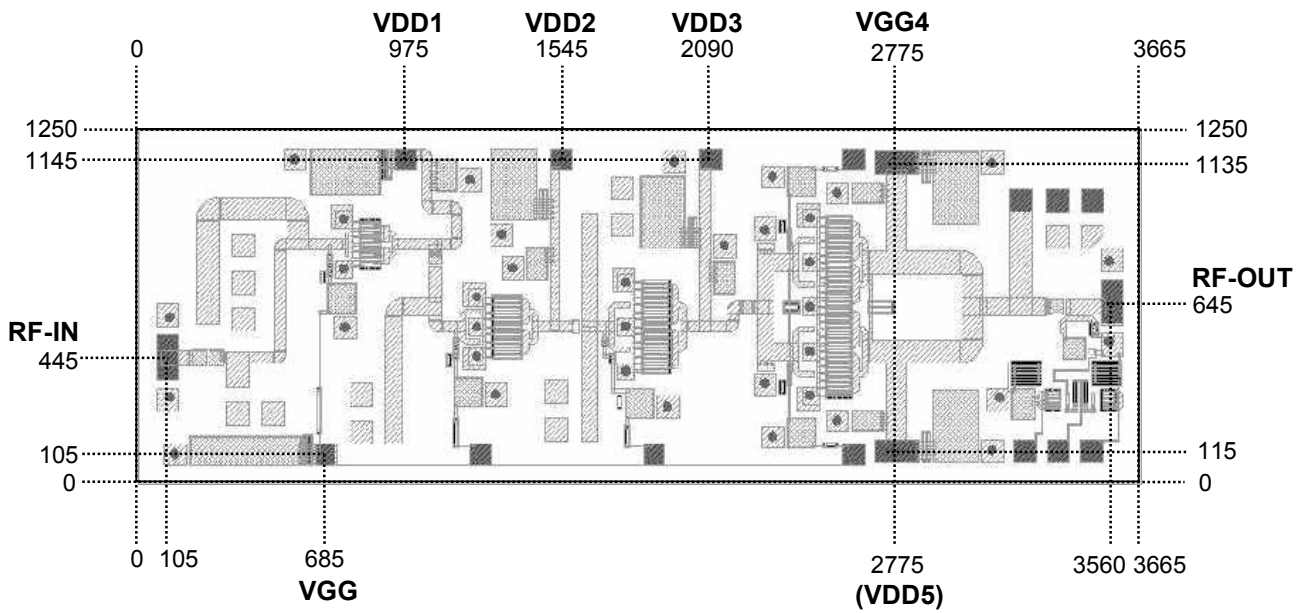

Chip Size :  $3665 \pm 30 \mu\text{m} \times 1250 \pm 30 \mu\text{m}$

Chip Thickness :  $60 \pm 20 \mu\text{m}$

Bonding Pad Size :

RF-Pad :  $80 \mu\text{m} \times 160 \mu\text{m}$

VGG, VDD1~3 Pad :  $80 \mu\text{m} \times 80 \mu\text{m}$

VDD4, VDD5 Pad :  $160 \mu\text{m} \times 80 \mu\text{m}$

Note : Drain voltage is required from either or both bonding pad( VDD4 or/and VDD5).

---

---

---

# FMM5823X

K-Band Power Amplifier MMIC

## ■ Assembly Diagrams

### Recommended assembly

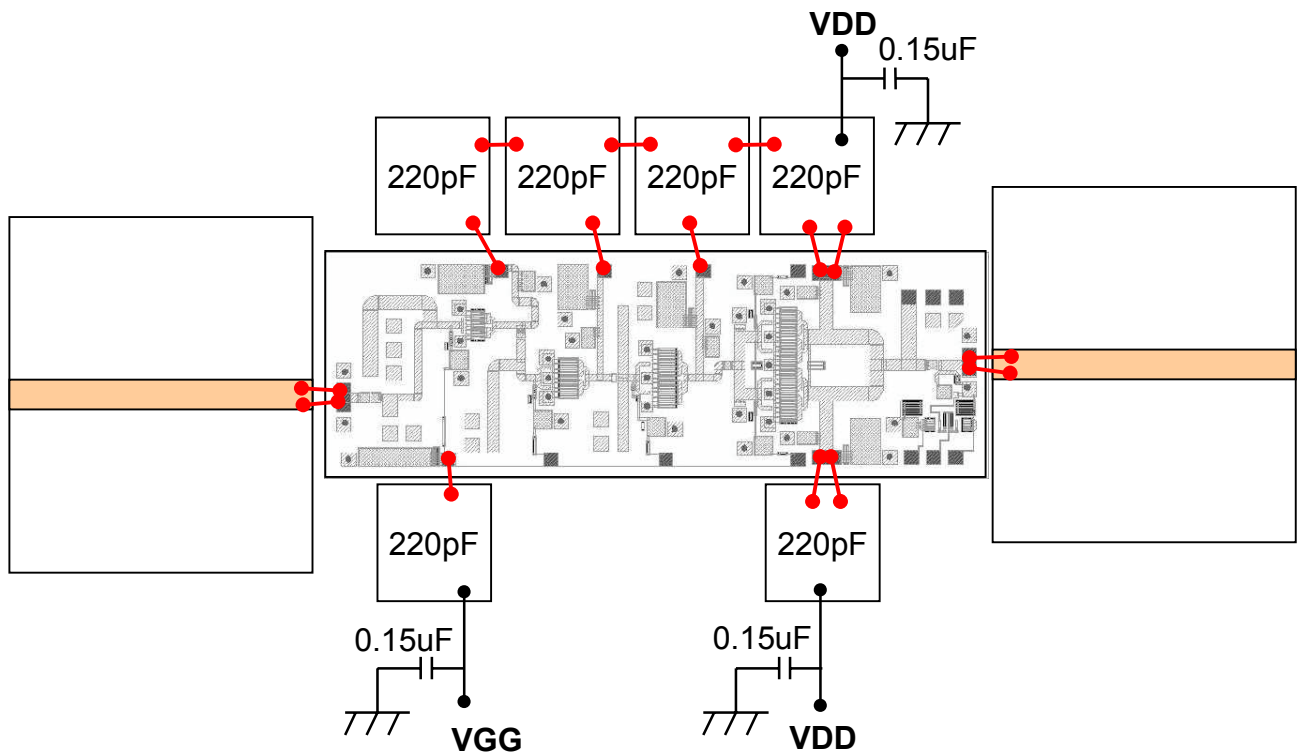

“Copper” is the recommended material for the package or carrier.

# FMM5823X

## K-Band Power Amplifier MMIC

### ■ DIE ATTACH

- 1) The die-attach station must have accurate temperature control and an inert forming gas should be used.
- 2) Chips should be kept at room temperature except during die-attach.
- 3) Place package or carrier on the heated stage.
- 4) Lightly grasp the chip edges by the longer side using tweezers.

#### Die attach conditions

Stage Temperature : 300 to 310 deg.C

Time : less than 15 seconds

AuSn Preform Volume : per next Figure

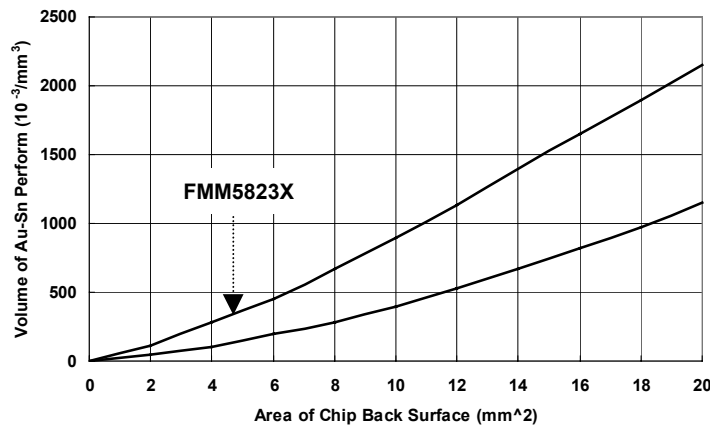

### ■ WIRE BONDING

The bonding equipment must be properly grounded. The following or equivalent equipment, tools, materials, and conditions are recommended.

- 1) Bonding Equipment and Bonding Tool.

Bonding Equipment : West Bond Model 7400 (Manual Bonder)

Bonding Tool : CCOD-1/16-S-437-60-F-2010-MP (Deweyl)

- 2) Bonding Wire

Material : Hard or Half hard gold

Diameter : 0.7 to 1.0 mil

- 3) Bonding Conditions

Method : Thermal Compression Bonding with Ultrasonic Power

Tool Force : 0.196 N  $\pm$  0.0196 N

Stage Temperature : 215 deg.C  $\pm$  5 deg.C

Tool Heater : None

Ultrasonic Power Transmitter : West Bond Model 1400

Duration : 150 mS/Bond

---

# FMM5823X

## K-Band Power Amplifier MMIC

For further information please contact :

**Eudyna Devices USA Inc.**  
2355 Zanker Rd.  
San Jose, CA 95131-1138, U.S.A.  
TEL: +1 408 232-9500  
FAX: +1 408 428-9111

**Eudyna Devices Europe Ltd.**  
Network House  
Norreys Drive  
Maidenhead, Berkshire SL6 4FJ  
United Kingdom  
TEL: +44 (0) 1628 504800  
FAX: +44 (0) 1628 504888

**Eudyna Devices International Srl**  
Via Teglio 8/2 - 20158  
Milano, Italy  
TEL: +39-02-8738-1695

**Eudyna Devices Asia Pte. Ltd.**  
Hong Kong Branch  
Suite 1906B, Tower 6, China Hong Kong City  
33 Canton Road, Tsimshatsui, Kowloon  
Hong Kong  
TEL: +852-2377-0227  
FAX: +852-2377-3921

**Eudyna Devices Inc.**  
1000 Kamisukiahara, showa-cho  
Nakakomagun, Yamanashi  
409-3883, Japan  
(Kokubo Industrial Park)  
TEL +81-55-275-4411  
FAX +81-55-275-9461

**Sales Division**  
1, Kanai-cho, Sakae-ku  
Yokohama, 244-0845, Japan  
TEL +81-45-853-8156  
FAX +81-45-853-8170

### CAUTION

Eudyna Devices Inc. products contain **gallium arsenide (GaAs)** which can be hazardous to the human body and the environment. For safety, observe the following procedures:

- Do not put these products into the mouth.
- Do not alter the form of this product into a gas, powder, or liquid through burning, crushing, or chemical processing as these by-products are dangerous to the human body if inhaled, ingested, or swallowed.
- Observe government laws and company regulations when discarding this product. This product must be discarded in accordance with methods specified by applicable hazardous waste procedures.

Eudyna Devices Inc. reserves the right to change products and specifications without notice. The information does not convey any license under rights of Eudyna Devices Inc. or others.

© 2006 Eudyna Devices Inc.