

FMM5822X

K-Band Power Amplifier MMIC

FEATURES

- High Output Power; P1dB = 32.5 dBm (Typ.)
- High Linear Gain; GL = 22 dB(Typ.)
- Frequency Band ; 17.5 - 20.0 GHz
- High Linearity ; OIP3 = 41dBm
- Impedance Matched Zin/Zout = 50Ω

DESCRIPTION

The FMM5822X is a power amplifier MMIC that contains a three stage amplifier, internally matched, for standard communications band in 17.5 to 20.0GHz frequency range. This product is well suited for point-to-point radio applications.

Eudyna's stringent Quality Assurance Program assures the highest reliability and consistent performance.

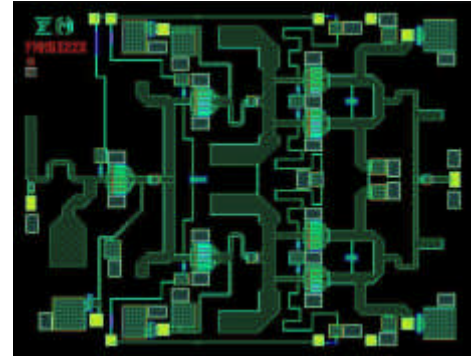

ABSOLUTE MAXIMUM RATING

Item	Symbol	Condition	Rating	Unit
Drain-Source Voltage	VDD		10	V
Gate-Source Voltage	VGG		-3	V
Input Power	Pin		25	dBm
Storage Temperature	Tstg		-55 to +125	

RECOMMENDED OPERATING CONDITIONS

Item	Symbol	Condition	Recommended	Unit
Drain-Source Voltage	VDD		7*	V
Input Power	Pin		15	dBm
Operating Backside Temperature	Top		-40 to +85	

* : FMM5822X/001 Recommended Drain-Source Voltage VDD = 8V

This Product should be hermetically packaged.

ELECTRICAL CHARACTERISTICS (Ambient Temperature Ta=25 °C)

Item	Symbol	Test Conditions	Limits			Unit
			Min.	Typ.	Max.	
Frequency Range	f	VDD=6.0V	17.5	-	20	GHz
Output Power at 1dB G.C.P.	P1dB	IDD(DC)=850mA typ.	30.5	32.5	-	dBm
Power Gain at 1dB G.C.P.	G1dB	Zs=Zl=50ohm	19	21	25	dB
Power Added Efficiency at 1dB G.C.P.	Nadd		-	30	-	%
Third Order Intermodulation	IM3*	*df=10MHz,Po=20.5dBm	-38	-41	-	dBc
Drain Current at 1dB G.C.P.	Iddrf	(S.C.L.)	-	1000	1500	mA
Input Return Loss at Pin=-20dBm	RLin		-	-8	-	dB
Output Return Loss at Pin=-20dBm	RLout		-	-12	-	dB

Note : RF parameter sample size 10ps. Criteria (accept/reject)=(0/1)

G.C.P. : Gain Compression Point

S.C.L. : Single Carrier Level

ESD	Class 0	~ 199V
------------	----------------	---------------

Note : Based on EIAJ ED-4701 C-111A(C=100pF, R=1.5k Ω)

FMM5822X

K-Band Power Amplifier MMIC

Output Power vs. Frequency

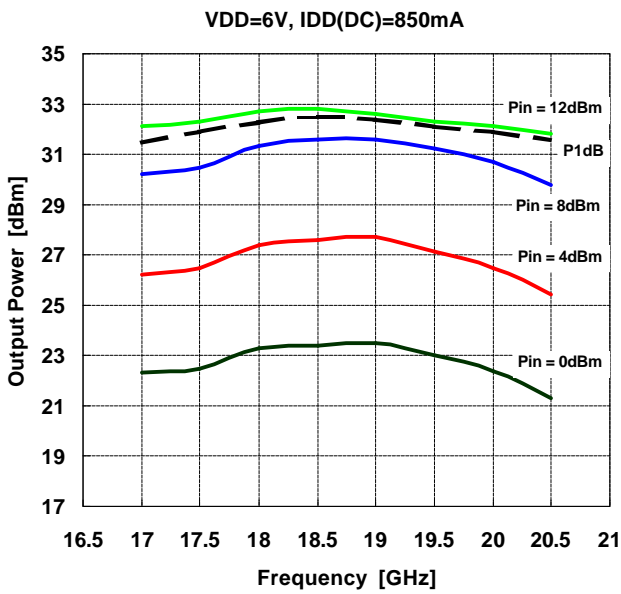

Output Power, Drain Current vs. Input Power

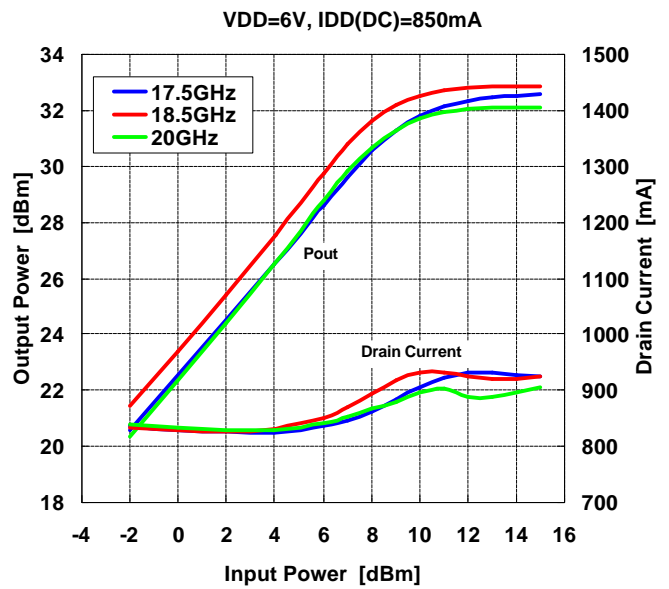

Power Added Efficiency vs. Frequency

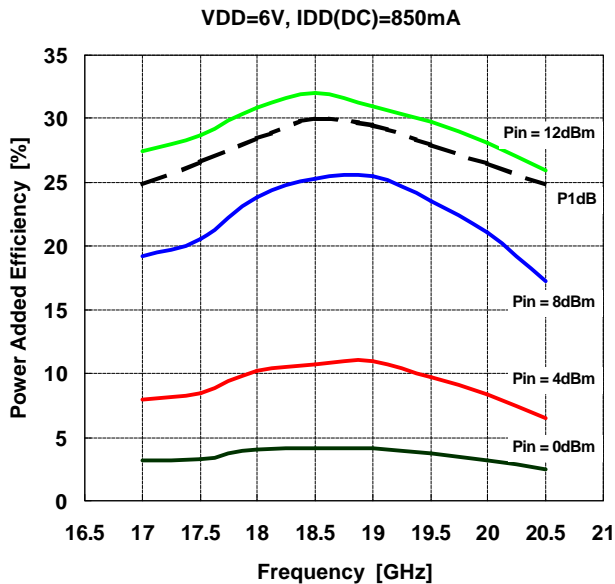

FMM5822X

K-Band Power Amplifier MMIC

IMD vs. Frequency

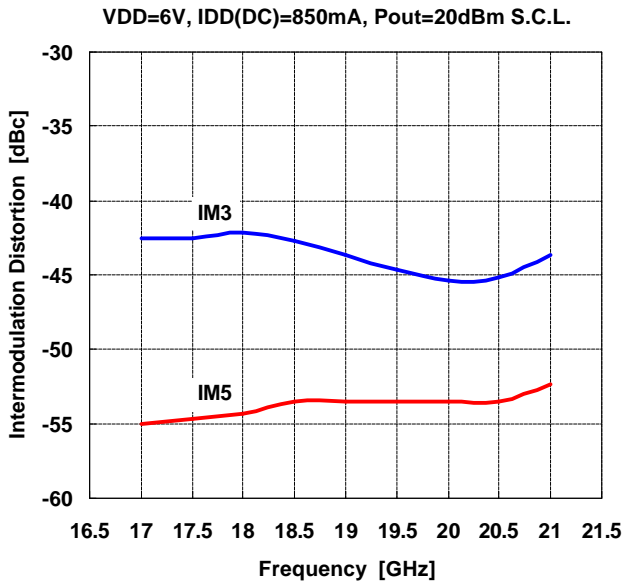

IMD vs. Output Power

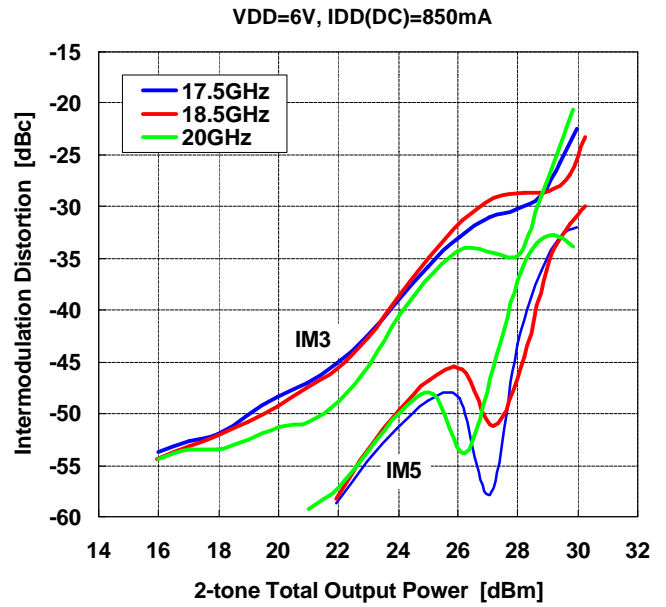

FMM5822X

K-Band Power Amplifier MMIC

Output Power, Drain Current vs. Input Power by Drain Voltage

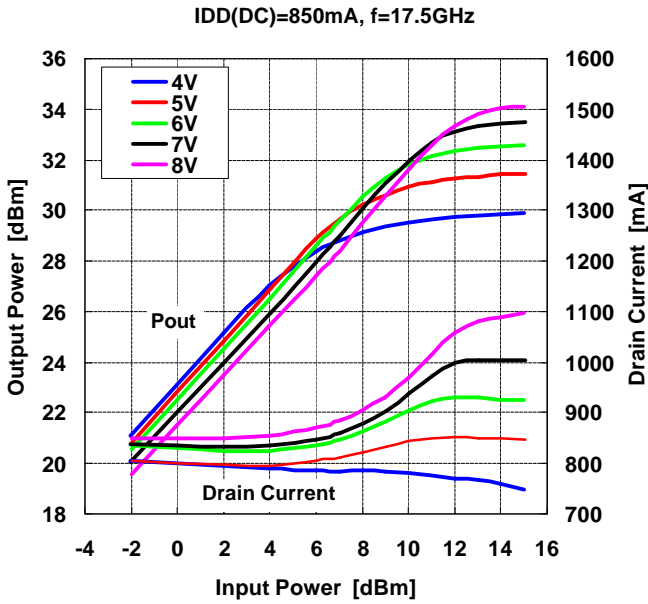

Output Power, Drain Current vs. Input Power by Drain Voltage

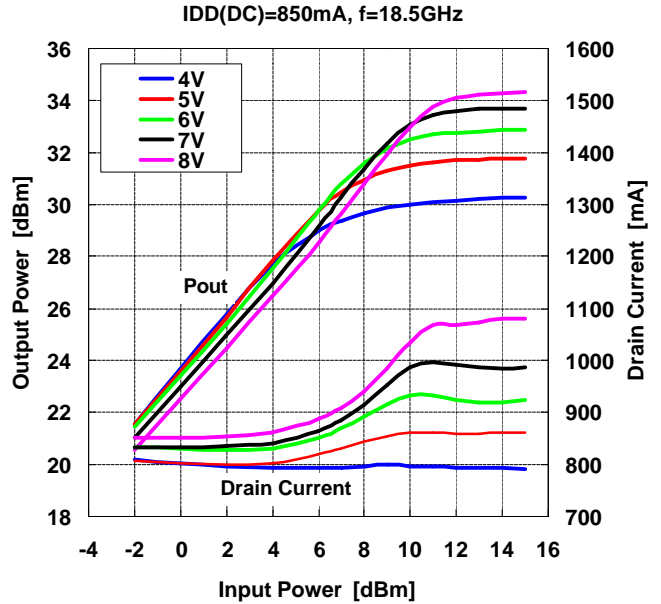

Output Power, Drain Current vs. Input Power by Drain Voltage

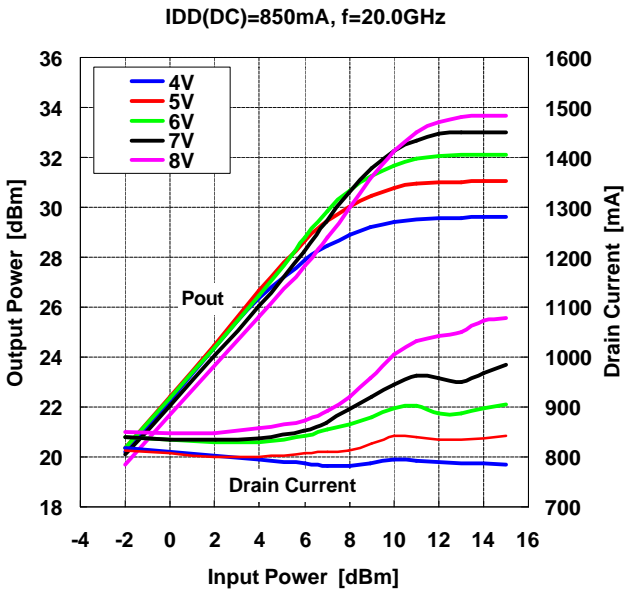

Output Power, Gain vs. Drain Voltage

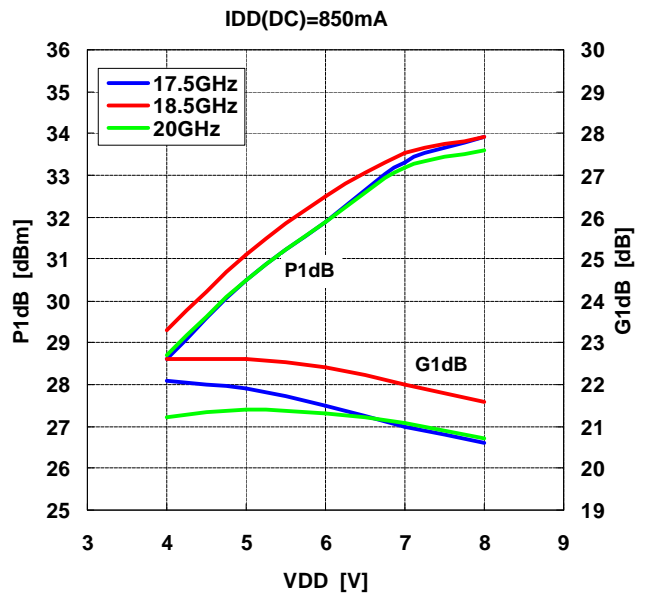

FMM5822X

K-Band Power Amplifier MMIC

Output Power, Drain Current vs. Input Power by Drain Current

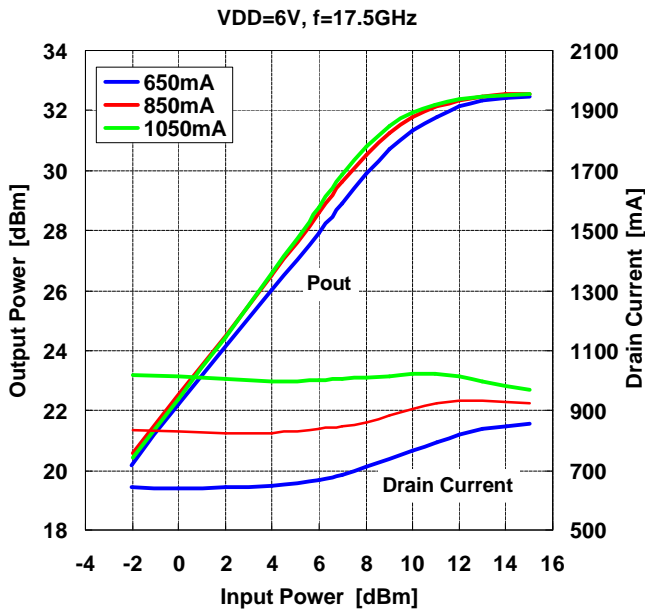

Output Power, Drain Current vs. Input Power by Drain Current

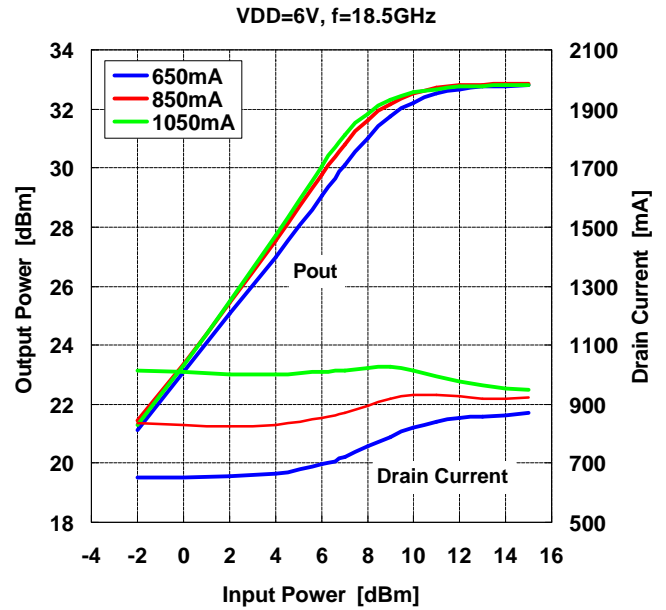

Output Power, Drain Current vs. Input Power by Drain Current

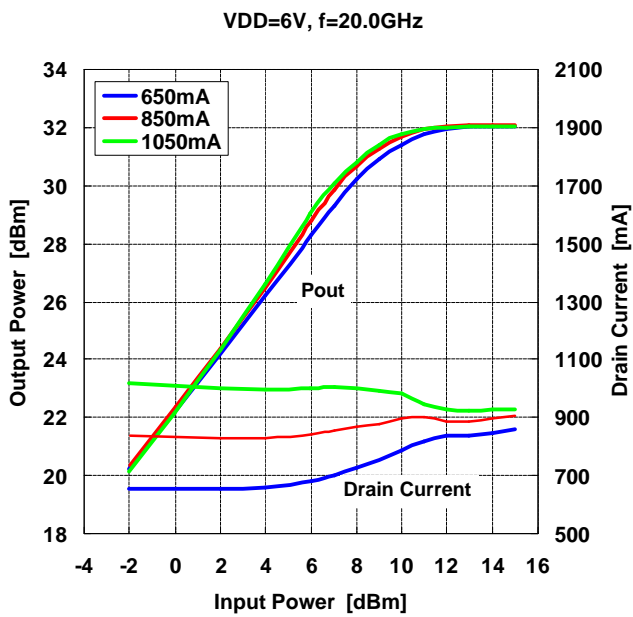

Output Power, Gain vs. Drain Current

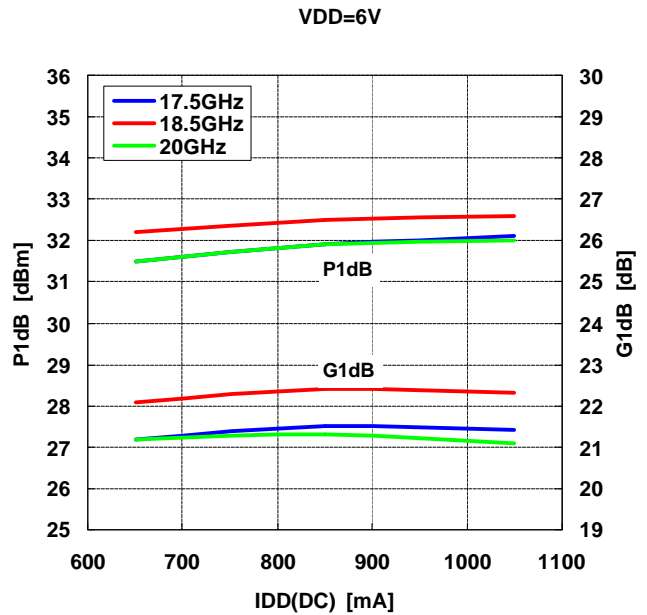

Eudyna

FMM5822X

K-Band Power Amplifier MMIC

IMD vs. Output Power
by Drain Voltage

IDD(DC)=850mA, f=17.5GHz

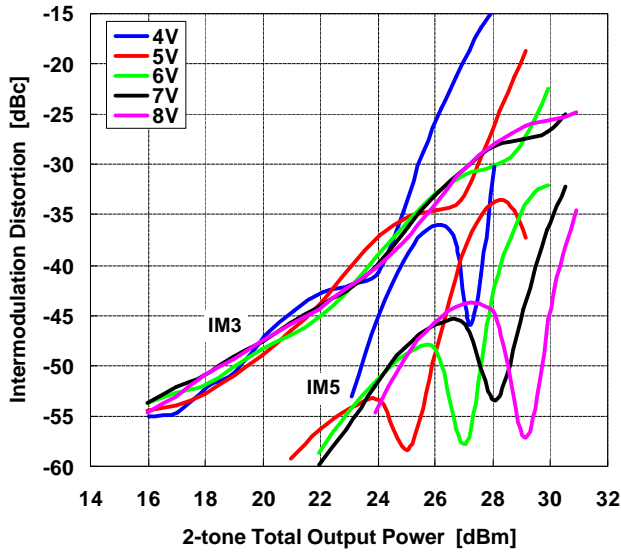

IMD vs. Output Power
by Drain Voltage

IDD(DC)=850mA, f=18.5GHz

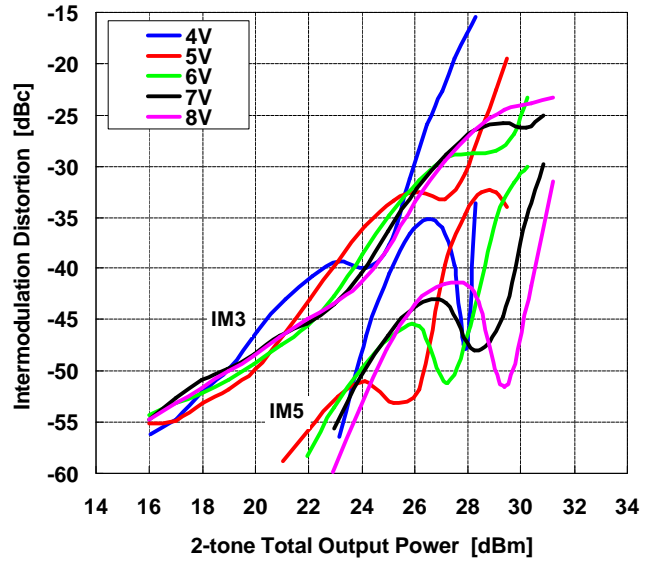

IMD vs. Output Power
by Drain Voltage

IDD(DC)=850mA, f=20.0GHz

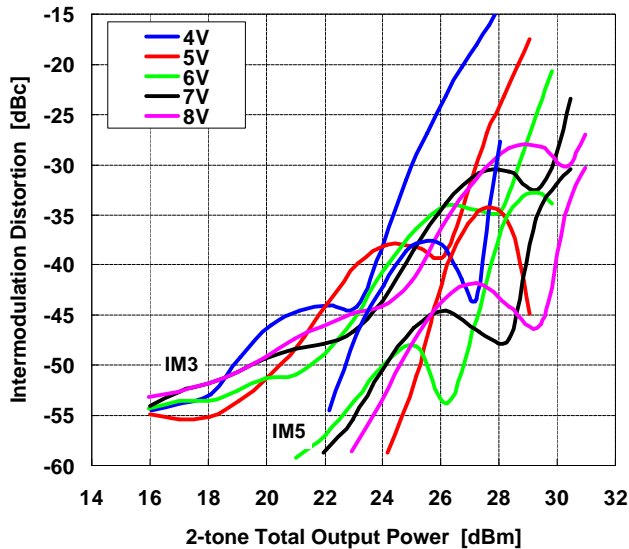

FMM5822X

K-Band Power Amplifier MMIC

IMD vs. Output Power
by Drain Current

VDD=6V, f=17.5GHz

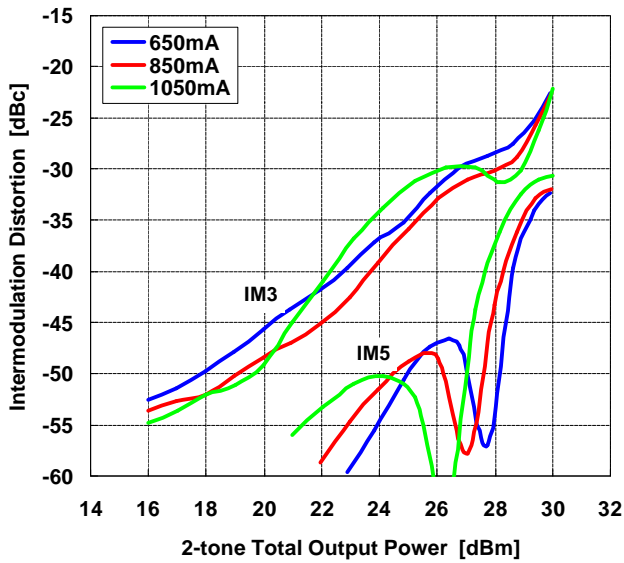

IMD vs. Output Power
by Drain Current

VDD=6V, f=18.5GHz

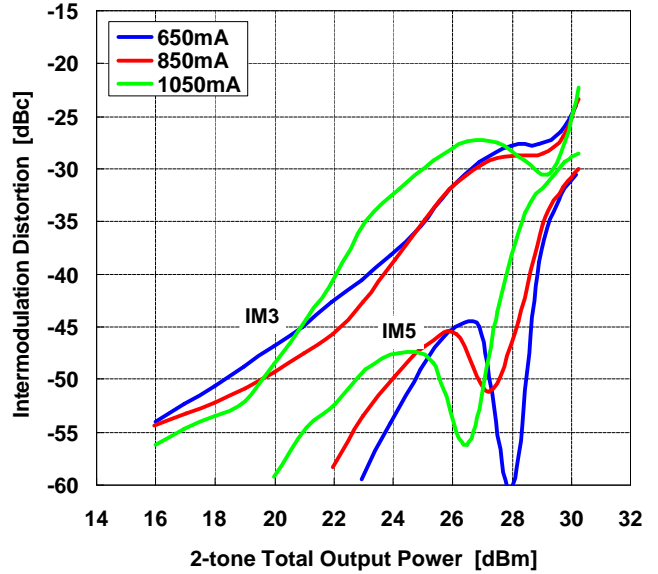

IMD vs. Output Power
by Drain Current

VDD=6V, f=20.0GHz

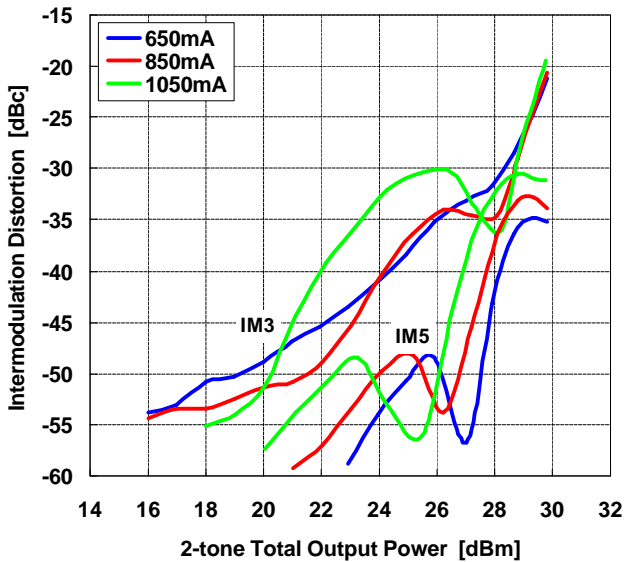

FMM5822X

K-Band Power Amplifier MMIC

S-PARAMETER

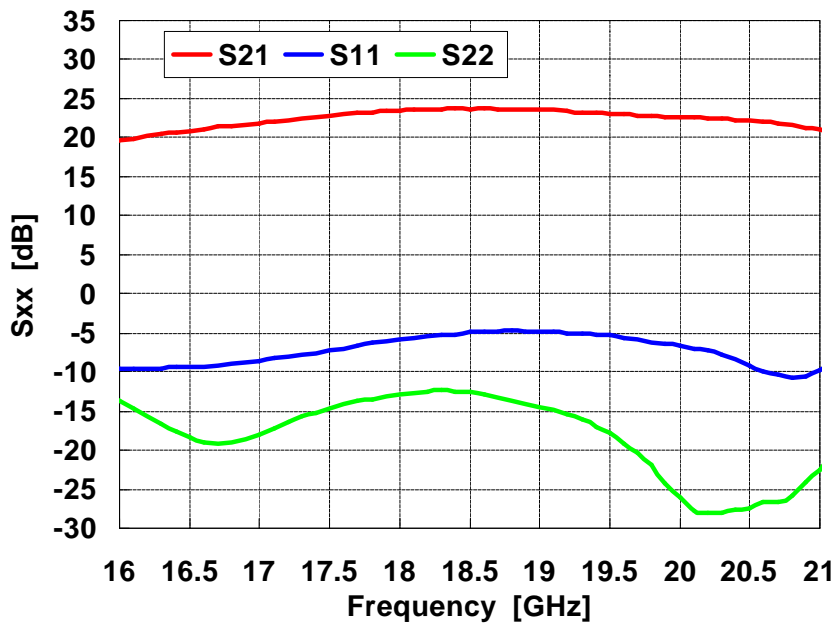
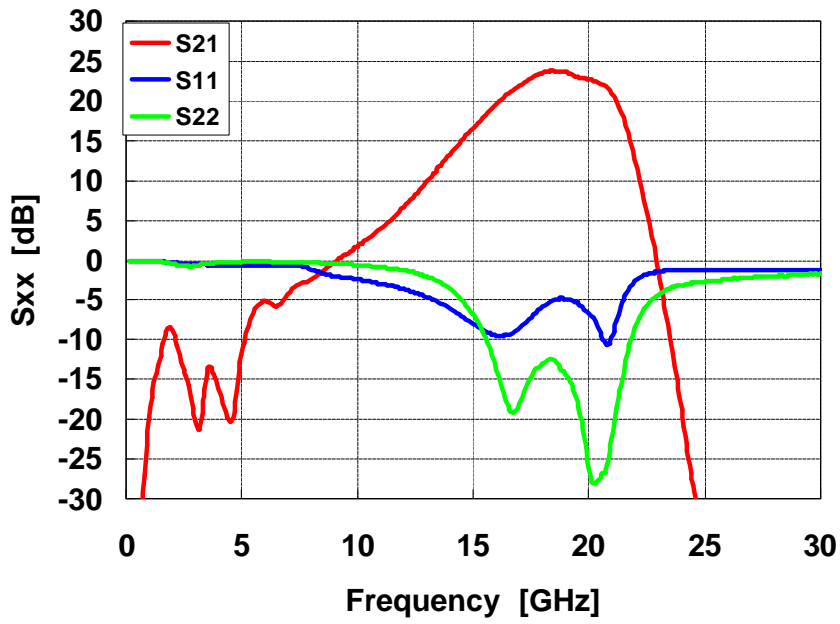

FMM5822X

K-Band Power Amplifier MMIC

S-PARAMETER

VDD=6V, IDD=850mA

Frequency [GHz]	S11		S21		S12		S22	
	MAG	ANG	MAG	ANG	MAG	ANG	MAG	ANG
1.0	0.98	-27.0	0.10	43.4	0.00	-106.0	0.99	-44.1
2.0	0.97	-52.2	0.36	-145.5	0.00	-128.4	0.94	-80.3
3.0	0.94	-73.4	0.10	145.9	0.00	-87.5	0.92	-102.7
4.0	0.93	-91.8	0.16	123.0	0.00	-108.9	0.96	-121.7
5.0	0.93	-108.1	0.26	163.1	0.00	-111.3	0.98	-137.4
6.0	0.93	-122.9	0.55	83.8	0.00	-95.4	0.98	-150.8
7.0	0.93	-137.6	0.61	45.3	0.00	-81.8	0.97	-162.1
8.0	0.87	-153.7	0.76	0.4	0.00	-62.2	0.96	-172.0
9.0	0.79	-163.6	0.97	-38.0	0.00	-80.7	0.95	177.9
10.0	0.75	-173.6	1.22	-78.6	0.00	-104.3	0.93	167.5
11.0	0.71	175.2	1.58	-117.2	0.00	-131.4	0.90	156.2
12.0	0.66	162.3	2.16	-157.4	0.00	173.8	0.86	142.7
13.0	0.59	147.3	3.11	158.4	0.00	-42.1	0.79	125.8
14.0	0.50	128.4	4.60	108.1	0.00	-25.2	0.66	103.2
15.0	0.40	103.9	6.75	51.6	0.00	-39.4	0.45	72.4
16.0	0.33	70.4	9.61	-11.8	0.00	-40.1	0.20	25.0
17.0	0.37	16.9	12.43	-82.7	0.01	-48.2	0.13	-93.4
17.1	0.39	11.1	12.66	-89.6	0.01	-47.9	0.14	-104.1
17.2	0.39	4.6	13.01	-97.0	0.01	-53.1	0.15	-112.5
17.3	0.41	-1.2	13.24	-104.4	0.01	-53.3	0.16	-119.7
17.4	0.42	-7.4	13.56	-111.8	0.01	-53.6	0.17	-126.9
17.5	0.43	-12.8	13.78	-119.8	0.01	-59.5	0.19	-132.7
17.6	0.45	-18.9	14.07	-127.1	0.01	-57.0	0.20	-140.4
17.7	0.46	-24.9	14.38	-135.3	0.00	-70.9	0.21	-146.6
17.8	0.48	-30.1	14.50	-143.1	0.01	-67.3	0.21	-153.6
17.9	0.49	-36.5	14.90	-151.0	0.01	-72.1	0.22	-159.3
18.0	0.51	-41.6	14.96	-159.6	0.01	-84.9	0.22	-164.7
18.1	0.52	-47.4	15.18	-167.5	0.01	-78.6	0.23	-170.8
18.2	0.53	-52.5	15.31	-176.4	0.01	-80.5	0.23	-176.3
18.3	0.55	-57.9	15.27	175.8	0.01	-77.5	0.24	178.5
18.4	0.55	-63.4	15.43	166.9	0.01	-83.1	0.24	172.8
18.5	0.57	-68.9	15.25	158.8	0.01	-97.7	0.23	166.8
18.6	0.57	-74.4	15.34	150.6	0.01	-97.8	0.23	160.6
18.7	0.57	-79.3	15.23	141.9	0.01	-101.9	0.22	154.6
18.8	0.58	-85.3	15.22	134.1	0.01	-112.6	0.21	151.1
18.9	0.57	-89.9	15.19	125.4	0.01	-110.9	0.20	144.4
19.0	0.57	-94.9	15.03	116.9	0.01	-114.1	0.19	138.4
19.1	0.57	-100.3	15.02	108.4	0.01	-127.0	0.18	132.5
19.2	0.56	-104.8	14.75	99.5	0.01	-121.8	0.17	126.5
19.3	0.56	-110.0	14.55	91.4	0.00	-141.5	0.16	119.3
19.4	0.54	-115.1	14.36	82.9	0.00	-148.2	0.14	114.1
19.5	0.54	-120.1	14.07	75.0	0.01	-138.9	0.13	109.6
19.6	0.52	-125.2	14.01	66.9	0.00	-158.6	0.11	100.4
19.7	0.51	-130.1	13.78	58.4	0.00	-174.6	0.10	92.9
19.8	0.49	-136.3	13.76	50.5	0.00	155.8	0.08	80.4
19.9	0.47	-141.0	13.64	41.4	0.00	133.3	0.06	70.4
20.0	0.46	-147.8	13.54	33.1	0.00	104.2	0.05	63.2
21.0	0.33	70.0	11.17	-70.5	0.01	-1.2	0.08	15.6
22.0	0.73	-36.9	4.27	174.8	0.01	-60.8	0.37	-24.4
23.0	0.85	-75.1	0.84	90.0	0.00	-81.5	0.61	-68.8
24.0	0.87	-94.6	0.11	45.9	0.00	49.0	0.70	-95.2
25.0	0.87	-107.0	0.02	88.6	0.01	-11.8	0.73	-111.2
26.0	0.87	-115.5	0.02	91.1	0.01	-41.2	0.76	-122.1
27.0	0.87	-122.5	0.02	57.6	0.01	-21.4	0.78	-130.6
28.0	0.86	-127.7	0.02	36.7	0.01	-1.4	0.79	-137.9
29.0	0.86	-131.8	0.02	0.2	0.02	-13.2	0.81	-143.8
30.0	0.87	-135.6	0.02	-20.5	0.02	-30.0	0.83	-149.6

FMM5822X

K-Band Power Amplifier MMIC

Tch vs. Drain Voltage
(Reference)

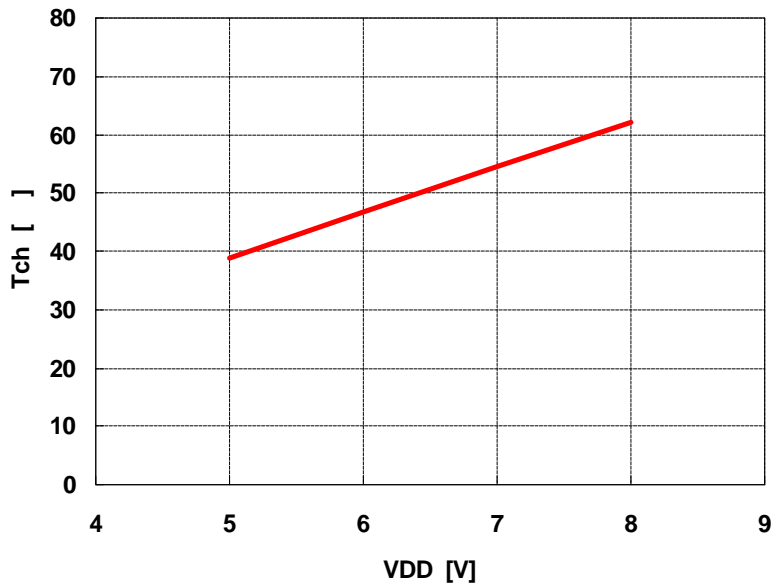

MTTF vs. Tch

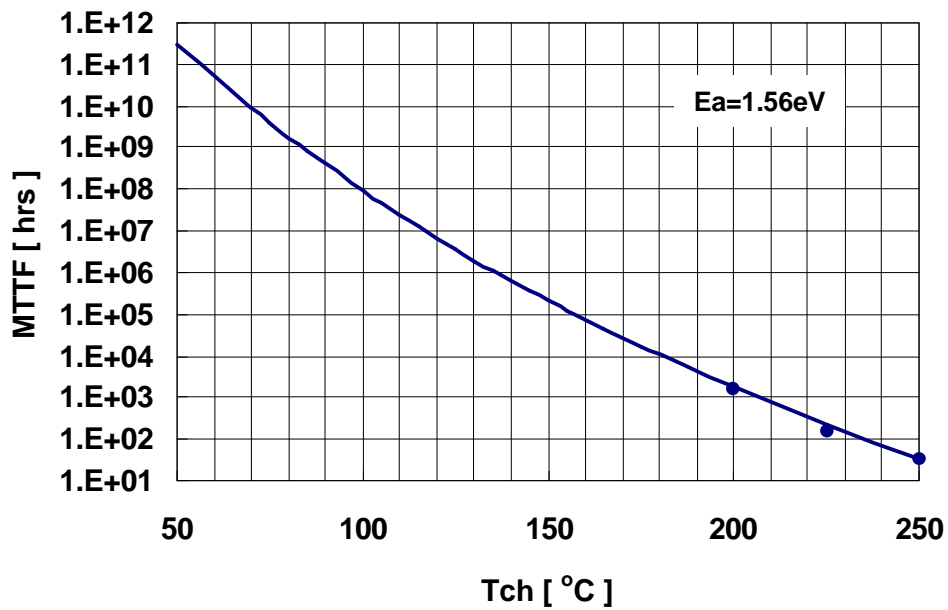

FMM5822X

K-Band Power Amplifier MMIC

Chip Outline and Bonding Pad Locations (Dimension in Micro-Meters)

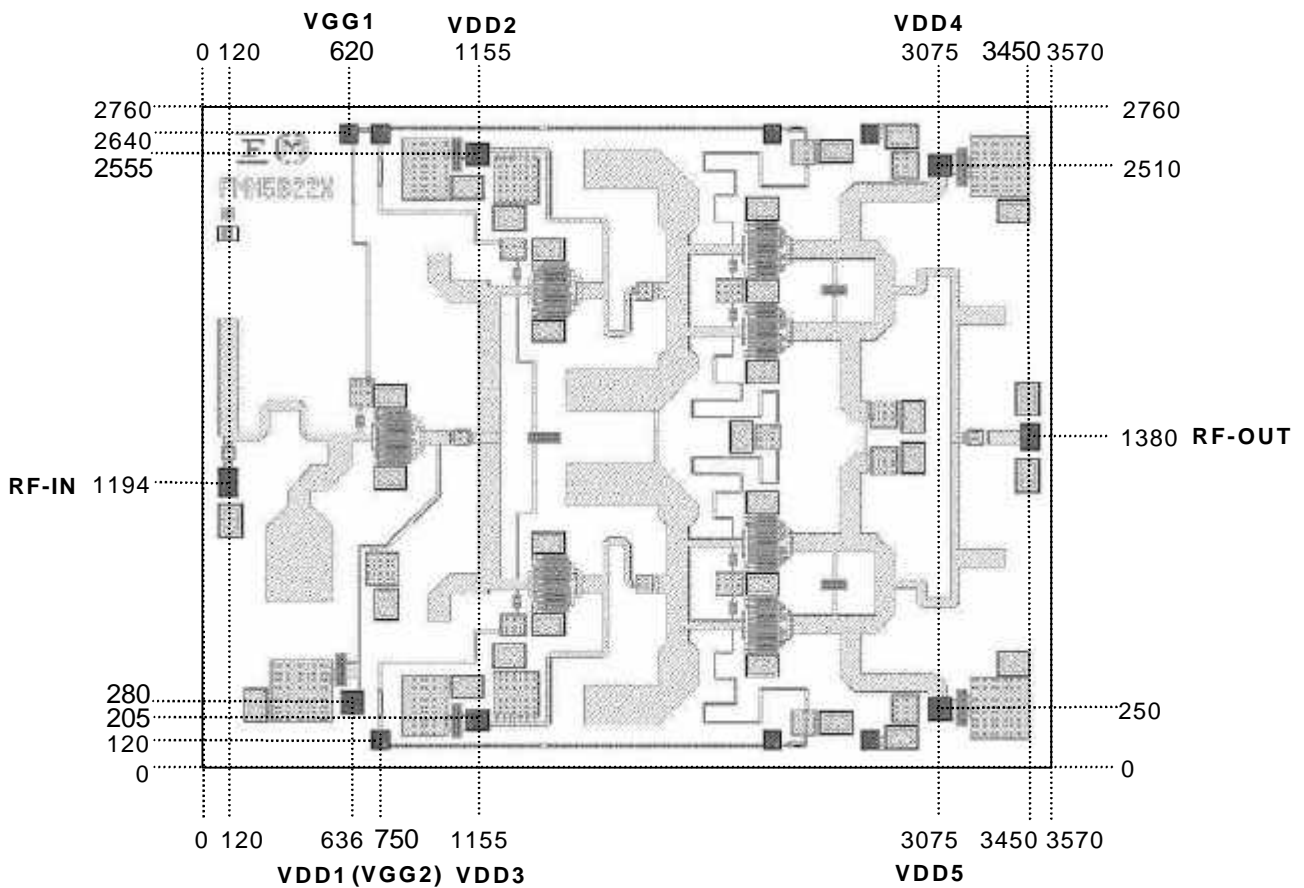

Chip Size : $3570 \pm 30\mu\text{m} \times 2760 \pm 30\mu\text{m}$

Chip Thickness : $70 \pm 20\mu\text{m}$

Bonding Pad Size :

RF-Pad : $120\mu\text{m} \times 80\mu\text{m}$

VGG-Pad : $80\mu\text{m} \times 80\mu\text{m}$

VDD-Pad : $100\mu\text{m} \times 100\mu\text{m}$

Note: Gate voltage is required from either or both bonding pad(VGG1 or/and VGG2).

FMM5822X

K-Band Power Amplifier MMIC

Assembly Diagrams

Recommended assembly

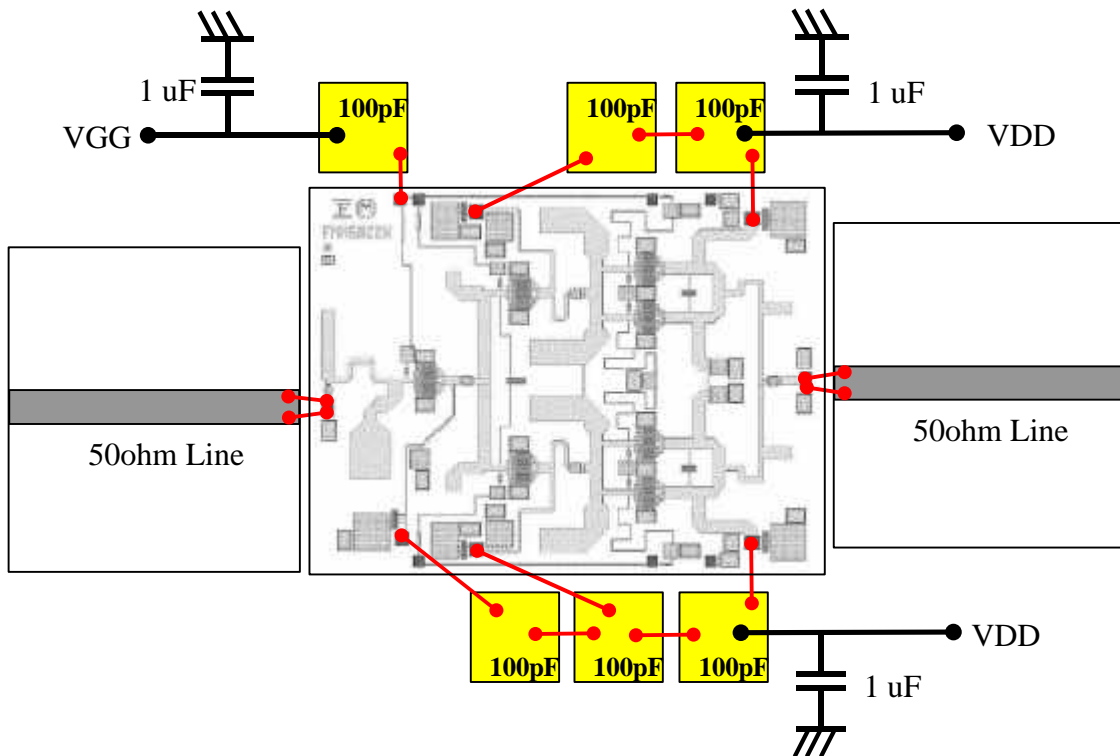

“Copper” is the recommended material for the package or carrier.

FMM5822X

K-Band Power Amplifier MMIC

DIE ATTACH

- 1) The die-attach station must have accurate temperature control and an inert forming gas should be used.
- 2) Chips should be kept at room temperature except during die-attach.
- 3) Place package or carrier on the heated stage.
- 4) Lightly grasp the chip edges by the longer side using tweezers.

Die attach conditions

Stage Temperature : 300 to 310 deg.C

Time : less than 15 seconds

AuSn Preform Volume : per next Figure

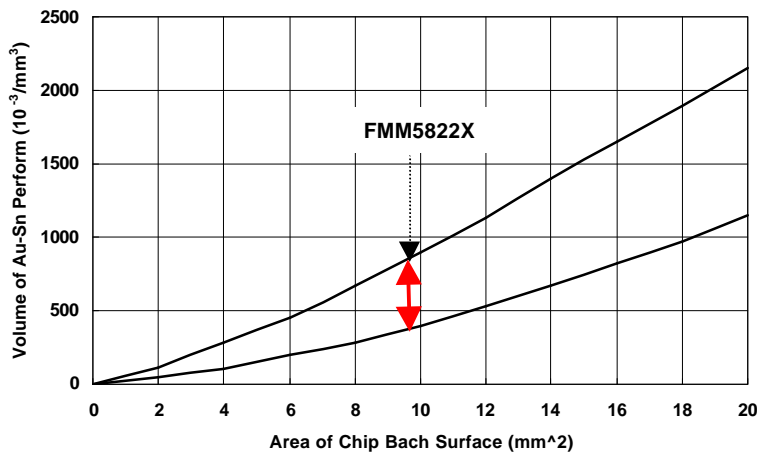

WIRE BONDING

The bonding equipment must be properly grounded. The following or equivalent equipment, tools, materials, and conditions are recommended.

1) Bonding Equipment and Bonding Tool.

Bonding Equipment : West Bond Model 7400 (Manual Bonder)

Bonding Tool : CCOD-1/16-S-437-60-F-2010-MP (Deweyl)

2) Bonding Wire

Material : Hard or Half hard gold

Diameter : 0.7 to 1.0 mil

3) Bonding Conditions

Method : Thermal Compression Bonding with Ultrasonic Power

Tool Force : $0.196 \text{ N} \pm 0.0196 \text{ N}$

Stage Temperature : $215 \text{ deg.C} \pm 5 \text{ deg.C}$

Tool Heater : None

Ultrasonic Power Transmitter : West Bond Model 1400

Duration : 150 mS/Bond

FMM5822X

K-Band Power Amplifier MMIC

For further information please contact :

Eudyna Devices USA Inc.
2355 Zanker Rd.
San Jose, CA 95131-1138, U.S.A.
TEL: (408) 232-9500
FAX: (408) 428-9111
www.us.eudyna.com

Eudyna Devices Europe Ltd.
Network House
Norreys Drive
Maidenhead, Berkshire SL6 4FJ
United Kingdom
TEL: +44 (0) 1628 504800
FAX: +44 (0) 1628 504888

Eudyna Devices Asia Pte. Ltd.
Hong Kong Branch
Rm.1101,Ocean Centre, 5 Canton Road
Tsim Sha Tsui, Kowloon, Hong Kong
TEL: +852-2377-0227
FAX: +852-2377-3921

Eudyna Devices Inc.
1000 Kamisukiahara, showa-cho
Nakakomagun, Yamanashi
409-3883, Japan
(Kokubo Industrial Park)
TEL +81-55-275-4411
FAX +81-55-275-9461
Sales Division
1, Kanai-cho, Sakae-ku
Yokohama, 244-0845, Japan
TEL +81-45-853-8156
FAX +81-45-853-8170

CAUTION

Eudyna Devices Inc. products contain **gallium arsenide (GaAs)** which can be hazardous to the human body and the environment. For safety, observe the following procedures:

Do not put these products into the mouth.

Do not alter the form of this product into a gas, powder, or liquid through burning, crushing, or chemical processing as these by-products are dangerous to the human body if inhaled, ingested, or swallowed.

Observe government laws and company regulations when discarding this product. This product must be discarded in accordance with methods specified by applicable hazardous waste procedures.

Eudyna Devices Inc. reserves the right to change products and specifications without notice. The information does not convey any license under rights of Eudyna Devices Inc. or others.

© 2004 Eudyna Devices USA Inc.
Printed in U.S.A.

Eudyna