

High Speed Translator Buffers: Single ended to PECL or LVDS

FEATURES

- Differential PECL (PLL130-68) or LVDS (PLL130-69) output.
- Accepts any single-ended REFIN input (with as low as 100mV swing).
- Internal AC coupling of REFIN
- Input range from 1.0MHz to 1.0 GHz.
- No Vref required.
- No external current source required.
- 2.5 to 3.3V operation.
- Available in 3x3mm QFN.

PIN CONFIGURATION

(TOP VIEW)

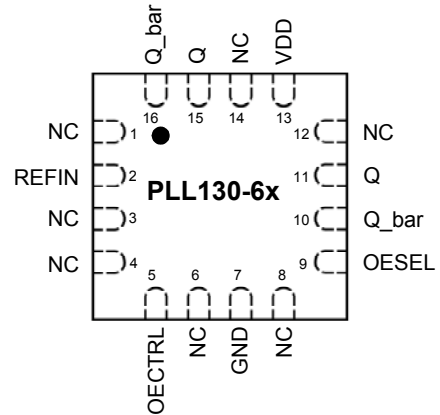

DESCRIPTION

The PLL130-68 and PLL130-69 are low cost, high performance, high speed, translator buffers that reproduce any input frequency from DC to 1.0GHz. They provide a pair of differential outputs (PECL for PLL130-68 or LVDS for PLL130-69). Thanks to an internal AC coupling of the reference input (REFIN), any input signal with at least 100mV swing can be used as reference signal, regardless of its DC value. These chips are ideal for conversion from clipped sine wave, TTL, CMOS, or differential signal to LVDS or PECL.

OUTPUT ENABLE LOGICAL LEVELS

PLL130-68

OESEL	OECTRL	OUTPUT STATE
0 (Default)	0 (Default)	Output enabled
	1	Tri-state
1	0	Tri-state
	1 (Default)	Output enabled

OECTRL input: Logical states defined by PECL levels.

PLL130-69

OESEL	OECTRL	OUTPUT STATE
0 (Default)	0	Tri-state
	1 (Default)	Output enabled
1	0 (Default)	Output enabled
	1	Tri-state

OECTRL input: Logical states defined by CMOS levels.

BLOCK DIAGRAM

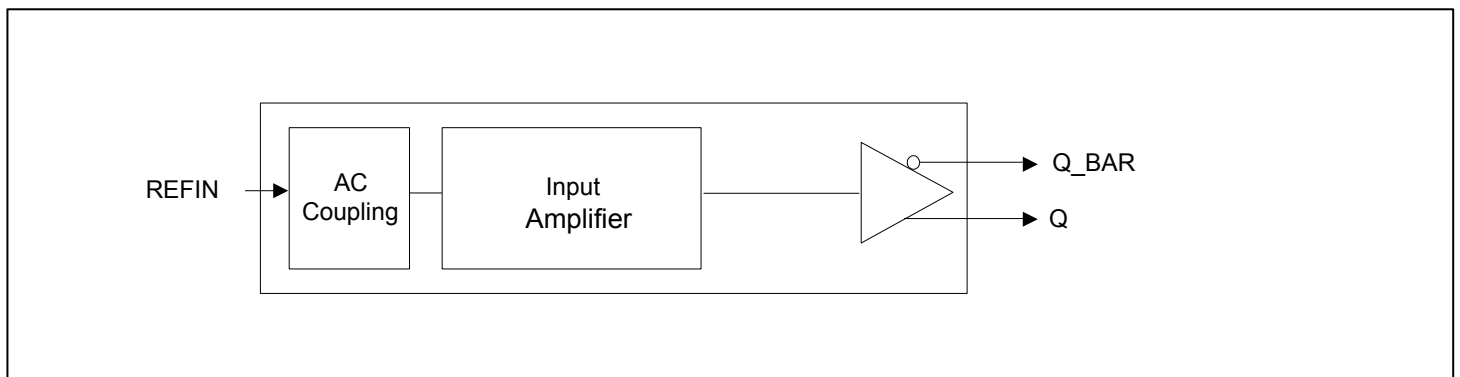

High Speed Translator Buffers: Single ended to PECL or LVDS

PIN DESCRIPTION

Name	Pin number	Type	Description
NC	1, 3, 4, 6, 8, 12, 14	-	No connection.
REFIN	2	I	Reference input signal. The frequency of this signal will be reproduced at the output (after translation to PECL or LVDS level).
OCTRL	5	I	Output enable input (See OE Logic Table on page 1).
GND	7	P	Ground connector.
OESSEL	9	I	Output enable logic selector (See OE Logic Table on page 1).
Q_BAR	10	O	Complementary output. PECL_bar on PLL130-68, LVDS_bar on PLL130-69.
Q	11	O	True output. PECL on PLL130-68, LVDS on PLL130-69.
VDD	13	P	3.3V Power supply.
Q	15	O	Additional true output. PECL on PLL130-68, LVDS on PLL130-69. This output is the same as pin 11.
Q_BAR	16	O	Additional complementary output. PECL_bar on PLL130-68, LVDS_bar on PLL130-69. This output is the same as pin 10.

ELECTRICAL SPECIFICATIONS

1. Absolute Maximum Ratings

PARAMETERS	SYMBOL	MIN.	MAX.	UNITS
Supply Voltage	V_{DD}		4.6	V
Input Voltage, dc	V_I	-0.5	$V_{DD}+0.5$	V
Output Voltage, dc	V_O	-0.5	$V_{DD}+0.5$	V
Storage Temperature	T_S	-65	150	°C
Ambient Operating Temperature*	T_A	-40	85	°C
Junction Temperature	T_J		125	°C
Lead Temperature (soldering, 10s)			260	°C
ESD Protection, Human Body Model			2	kV

Exposure of the device under conditions beyond the limits specified by Maximum Ratings for extended periods may cause permanent damage to the device and affect product reliability. These conditions represent a stress rating only, and functional operations of the device at these or any other conditions above the operational limits noted in this specification is not implied.

* **Note:** Operating Temperature is guaranteed by design for all parts (COMMERCIAL and INDUSTRIAL), but tested for COMMERCIAL grade only.

2. General Electrical Specifications

PARAMETERS	SYMBOL	CONDITIONS	MIN.	TYP.	MAX.	UNITS
Supply Current (both outputs loaded)	I_{DD}	$F_{out} = 156.25\text{MHz}$, PECL	45	48	51	mA
		$F_{out} = 156.25\text{MHz}$, LVDS	22	25	28	
Operating Voltage	V_{DD}		2.97		3.63	V
Output Clock Duty Cycle		@ $V_{dd} - 1.3\text{V}$ (PECL)	Same as input			%
		@ 1.25V (LVDS)	Same as input			
Short Circuit Current				±50		mA

High Speed Translator Buffers: Single ended to PECL or LVDS

3. AC Specifications

PARAMETERS	CONDITIONS	MIN.	TYP.	MAX.	UNITS
Input Frequency		0		1000	MHz
Input signal swing	REFIN input	100			mV
Output Frequency		0		1000	MHz

4. PECL Electrical Characteristics

PARAMETERS	SYMBOL	CONDITIONS	MIN.	MAX.	UNITS
Output High Voltage	V_{OH}	$R_L = 50 \Omega$ to $(V_{DD} - 2V)$ (see figure)	$V_{DD} - 1.025$	$V_{DD} - 0.880$	V
Output Low Voltage	V_{OL}		$V_{DD} - 1.810$	$V_{DD} - 1.620$	V

5. PECL Switching Characteristics

PARAMETERS	SYMBOL	CONDITIONS	MIN.	TYP.	MAX.	UNITS
Clock Rise Time	t_r	@20/80% - PECL		0.2	0.5	ns
Clock Fall Time	t_f	@80/20% - PECL		0.2	0.5	ns

PECL Levels Test Circuit

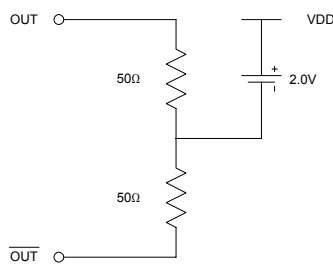

PECL Output Skew

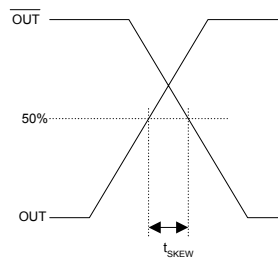

PECL Transistion Time Waveform

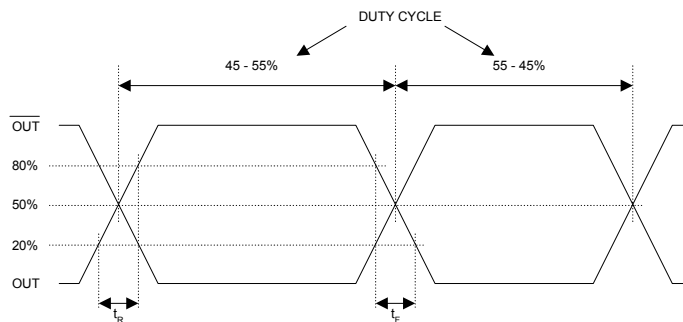

High Speed Translator Buffers: Single ended to PECL or LVDS

6. LVDS Electrical Characteristics

PARAMETERS	SYMBOL	CONDITIONS	MIN.	TYP.	MAX.	UNITS
Output Differential Voltage	V_{OD}	$R_L = 100 \Omega$ (see figure)	247	355	454	mV
V_{DD} Magnitude Change	ΔV_{OD}		-50		50	mV
Output High Voltage	V_{OH}		1.4	1.6	V	
Output Low Voltage	V_{OL}		0.9	1.1	V	
Offset Voltage	V_{OS}		1.125	1.2	1.375	V
Offset Magnitude Change	ΔV_{OS}		0	3	25	mV
Power-off Leakage	I_{OXD}	$V_{out} = V_{DD}$ or GND $V_{DD} = 0V$		± 1	± 10	μA
Output Short Circuit Current	I_{OSD}			-5.7	-8	mA

7. LVDS Switching Characteristics

PARAMETERS	SYMBOL	CONDITIONS	MIN.	TYP.	MAX.	UNITS
Differential Clock Rise Time	t_r	$R_L = 100 \Omega$ $C_L = 10 \text{ pF}$ (see figure)	0.2	0.5	1.0	ns
Differential Clock Fall Time	t_f		0.2	0.5	1.0	ns

LVDS Levels Test Circuit

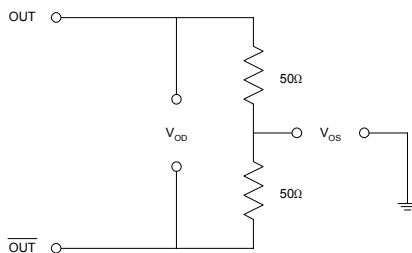

LVDS Switching Test Circuit

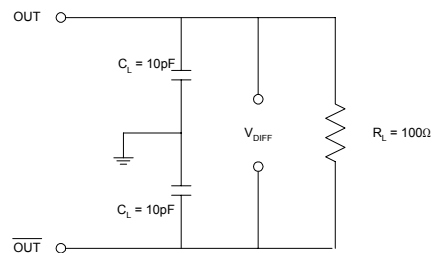

LVDS Transition Time Waveform

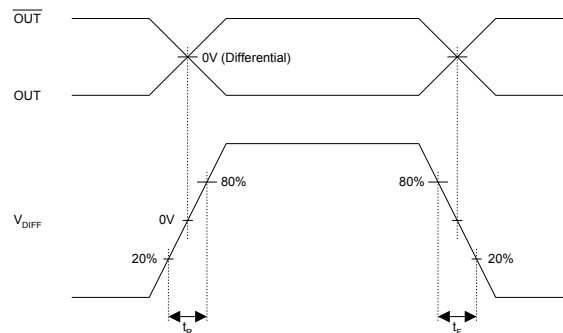

High Speed Translator Buffers: Single ended to PECL or LVDS

PACKAGE INFORMATION

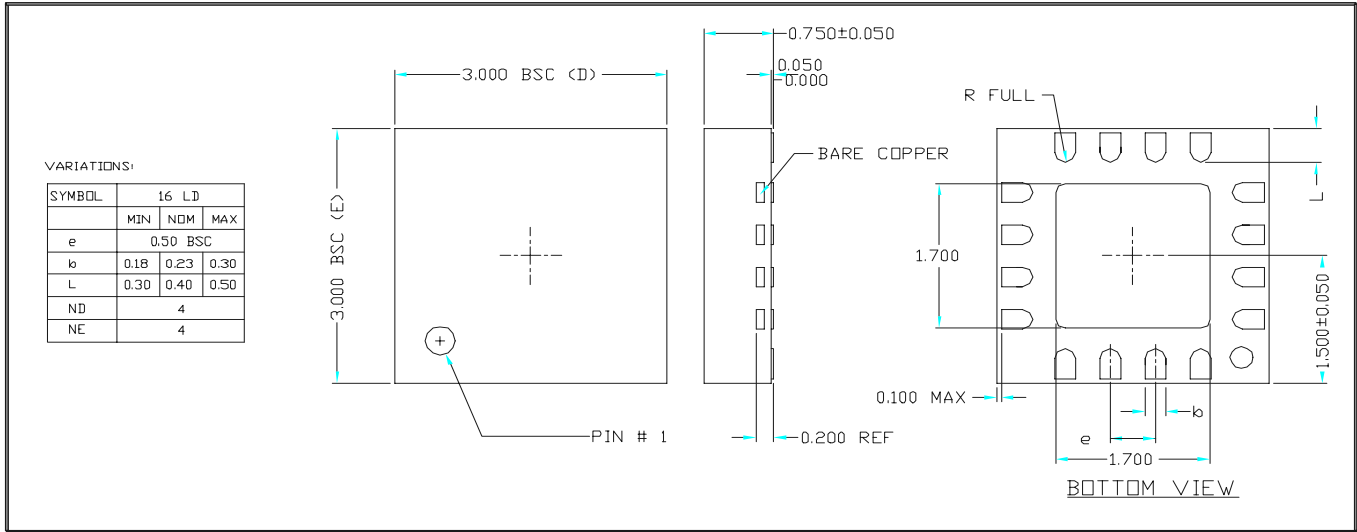

Important note: pin 1 indicator (bottom side) is metallized and connected to GND through the leadframe. Traces in contact with the pin 1 indicator may result in short circuit to GND.

ORDERING INFORMATION

For part ordering, please contact our Sales Department:
 47745 Fremont Blvd., Fremont, CA 94538, USA
 Tel: (510) 492-0990 Fax: (510) 492-0991

PART NUMBER

The order number for this device is a combination of the following:
 Device number, Package type and Operating temperature range

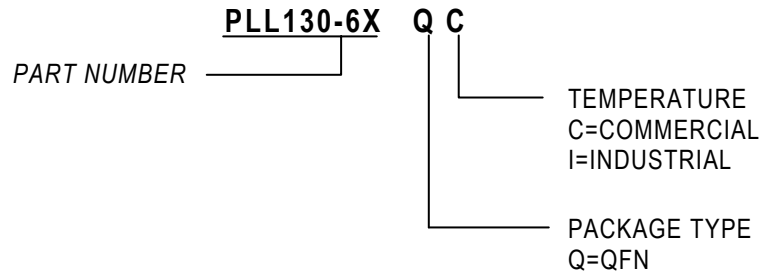

<u>Order Number</u>	<u>Marking</u>	<u>Package Option</u>
PLL130-68QC-R	P130-68	QFN - Tape and Reel
PLL130-68QC	P130-68	QFN - Tube
PLL130-69QC-R	P130-69	QFN - Tape and Reel
PLL130-69QC	P130-69	QFN - Tube

PhaseLink Corporation, reserves the right to make changes in its products or specifications, or both at any time without notice. The information furnished by Phaselink is believed to be accurate and reliable. However, PhaseLink makes no guarantee or warranty concerning the accuracy of said information and shall not be responsible for any loss or damage of whatever nature resulting from the use of, or reliance upon this product.

LIFE SUPPORT POLICY: PhaseLink's products are not authorized for use as critical components in life support devices or systems without the express written approval of the President of PhaseLink Corporation.