

## Step-Down Switching Regulator IC with Power Saving PWM/PFM control

### ■GENERAL DESCRIPTION

**NJU7631** is a high speed low voltage operation switching regulator control IC with power saving PWM/PFM control. Automatic PWM/PFM control improves power efficiency at light load. It features a totem pole driver that can directly drive an external MOS-FET.

Internal soft-start function, dead time control and timer latch function are included, requiring no external components. All parameters can be optimized by additional external components for design flexibility.

### ■FEATURES

- Automatic PWM/PFM Control
- Operating Voltage           2.2V to 8V
- Wide Oscillator Range       300kHz to 1MHz
- Maximum Duty Cycle        100%
- Quiescent Current           800μA typ.
- Soft-Start Function         Internal : 16ms typ. or adjustable
- Dead Time Control
- Timer Latch for Short Circuit Protection
- C-MOS Technology
- Package Outline             NJU7631RB1 : TVSP8

### ■PACKAGE OUTLINE



**NJU7631RB1**

### ■PRODUCT VARIATION

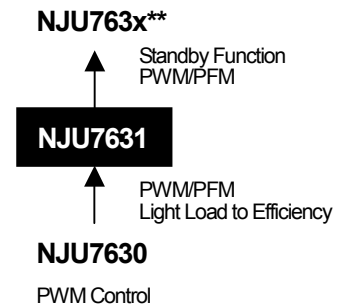

\*\* Planning

### ■PIN CONFIGURATION

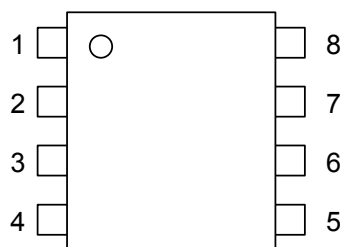

**NJU7631RB1**

#### PIN FUNCTION

1. OUT
2. V<sup>+</sup>
3. FB
4. IN-
5. SCP
6. DTC
7. RT
8. GND

# NJU7631

www.DataSheet4U.com

## ■BLOCK DIAGRAM

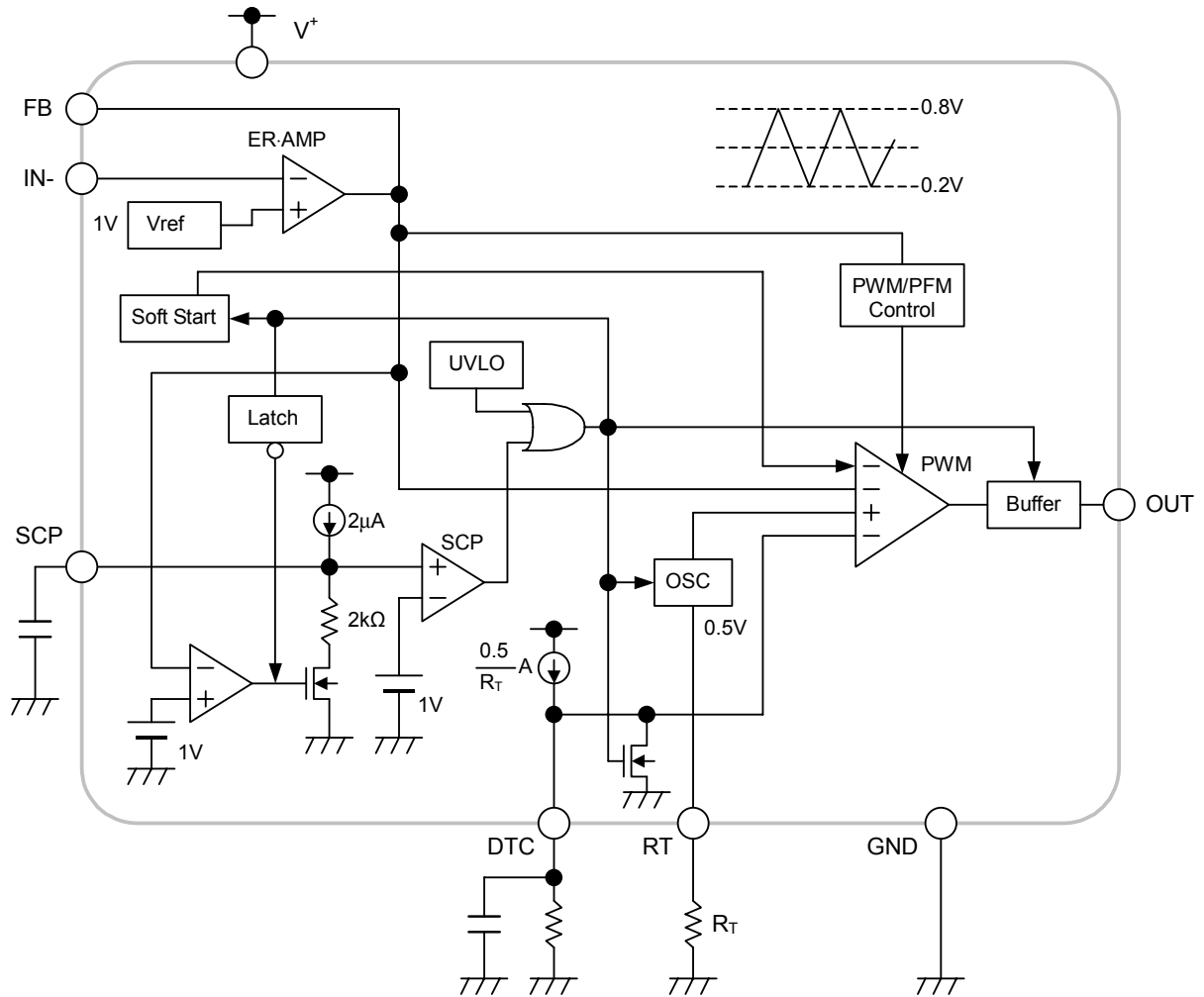

■ABSOLUTE MAXIMUM RATINGS (Ta=25°C)

PARAMETER	SYMBOL	MAXIMUM RATINGS	UNIT
Supply Voltage	V <sup>+</sup>	+9	V
Output Pin Current	I <sub>O</sub>	±50	mA
Power Dissipation	P <sub>D</sub>	TVSP8 :320	mW
Operating Temperature Range	T <sub>OPR</sub>	-40 ~ +85	°C
Storage Temperature Range	T <sub>STG</sub>	-40 ~ +125	°C

■RECOMMENDED OPERATING CONDITIONS (Ta=25°C)

PARAMETER	SYMBOL	MIN.	TYP.	MAX.	UNIT
Operating Voltage	V <sup>+</sup>	2.2	—	8	V
Oscillator Timing Resistor	R <sub>T</sub>	30	47	120	kΩ
Oscillation Frequency	f <sub>OSC</sub>	300	700	1,000	kHz

■ELECTRICAL CHARACTERISTICS (V<sup>+</sup>=3.3V, R<sub>T</sub>=47kΩ, Ta=25°C)

PARAMETER	SYMBOL	TEST CONDITION	MIN.	TYP.	MAX.	UNIT
<b>Under Voltage Lockout Block</b>						
ON Threshold Voltage	V <sub>T_ON</sub>	V <sup>+</sup> = L → H	1.9	2.0	2.1	V
OFF Threshold Voltage	V <sub>T_OFF</sub>	V <sup>+</sup> = H → L	1.8	1.9	2.0	V
Hysteresis Voltage	V <sub>HYS</sub>		60	100	—	mV
<b>Soft Start Block</b>						
Soft Start Time	T <sub>SS</sub>	V <sub>T_ON</sub> → Duty=80%	8	16	24	ms
<b>Short Circuit Protection Block</b>						
Input Threshold Voltage	V <sub>T_PC</sub>	FB Pin	0.95	1.00	1.05	V
Charge Current	I <sub>CHG</sub>	V <sub>SCP</sub> =0V	1.5	2	2.5	μA
Latch Mode ON Threshold Voltage	V <sub>T_LA</sub>	SCP Pin	0.95	1.00	1.05	V
Latch Mode OFF Threshold Voltage	V <sub>T_LAOFF</sub>	SCP Pin	0.2	0.45	0.7	V
<b>Oscillator Block</b>						
RT Pin Voltage	V <sub>RT</sub>		-5%	0.5	+5%	V
Oscillation Frequency	f <sub>OSC</sub>		630	700	770	kHz
Oscillate Supply Voltage Fluctuations	f <sub>DV</sub>	V <sup>+</sup> =2.2V ~ 8V	—	1	—	%
Oscillate Temperature Fluctuations	f <sub>DT</sub>	Ta=-40°C ~ +85°C	—	3	—	%

## ■ELECTRICAL CHARACTERISTICS ( $V^+=3.3V$ , $R_T=47k\Omega$ , $T_a=25^\circ C$ )

PARAMETER	SYMBOL	TEST CONDITION	MIN.	TYP.	MAX.	UNIT
-----------	--------	----------------	------	------	------	------

### Error Amplifier Block

Reference Voltage	$V_B$		-1.0%	1.00	+1.0%	V
Input Bias Current	$I_B$		-0.1	–	0.1	$\mu A$
Open Loop Gain	$A_V$		–	80	–	dB
Gain Bandwidth Product	$G_B$		–	1	–	MHz
Output Source Current	$I_{OM+1}$	$V_{FB}=1V$ , $V_{IN-}=0.9V$	25	55	95	mA
	$I_{OM+2}$	$V_{FB}=1V$ , $V_{IN-}=0.9V$ , $V^+=2.2V$	4	9	16	mA
Output Sink Current	$I_{OM-}$	$V_{FB}=1V$ , $V_{IN-}=1.1V$	0.10	0.16	0.22	mA

### PWM Compare Block

Input Threshold Voltage	$V_{T25}$	Duty= PFMD <sub>UTY</sub>	0.29	0.35	0.41	V
	$V_{T50}$	Duty=50%	0.44	0.5	0.56	V
Maximum Duty Cycle	$M_{AXD_{UTY1}}$	$V_{FB}=0.9V$	100	–	–	%
	$M_{AXD_{UTY2}}$	$V_{FB}=0.9V$ , $R_{DTC}=47k\Omega$	40	50	60	%
PWM/PFM Change Duty Cycle	PFMD <sub>UTY</sub>		17	25	33	%

### Output Block

Output High Level ON Resistance	$R_{OH}$	$I_O=-20mA$	–	10	20	$\Omega$
Output Low Level ON Resistance	$R_{OL}$	$I_O=+20mA$	–	5	10	$\Omega$

### General Characteristics

Quiescent Current	$I_{DD}$	$R_L=Non\ Load$	–	800	1200	$\mu A$
-------------------	----------	-----------------	---	-----	------	---------

## ■ TYPICAL APPLICATIONS

### Step-Down Converter

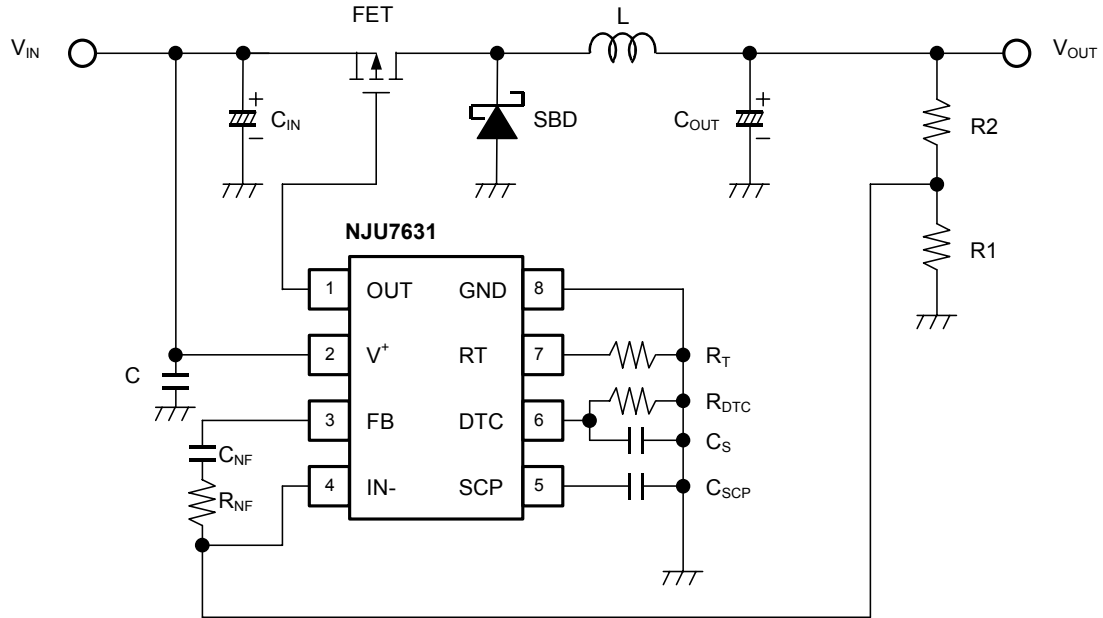

## ■ TYPICAL CHARACTERISTICS

Oscillation Frequency vs. Timing Resistance

( $V^+ = 3.3V$ ,  $T_a = 25^\circ C$ )

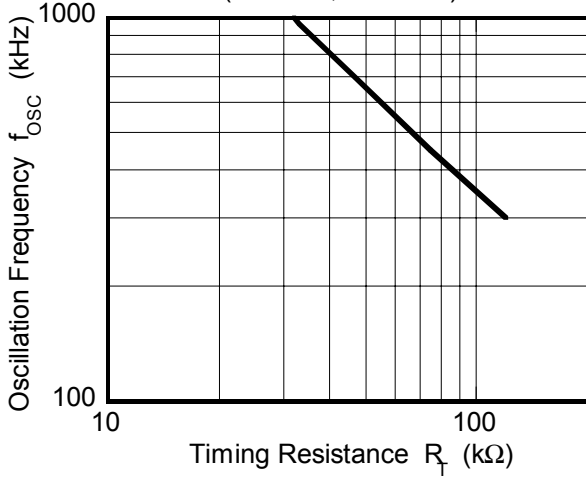

Oscillation Frequency vs. Operating Voltage

( $R_T = 47k\Omega$ ,  $T_a = 25^\circ C$ )

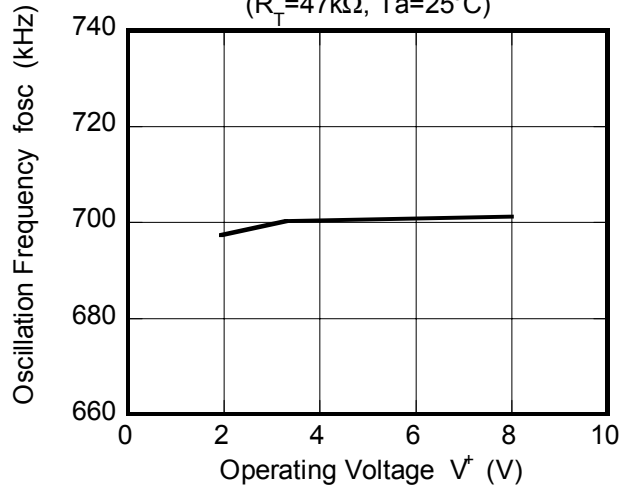

Duty Cycle vs.  $R_{DTC}$

( $V^+ = 3.3V$ ,  $R_T = 47k\Omega$ ,  $T_a = 25^\circ C$ )

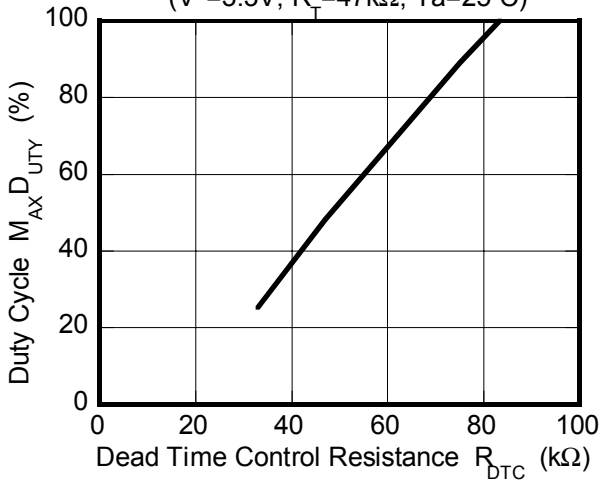

Reference Voltage vs. Operating Voltage

( $T_a = 25^\circ C$ )

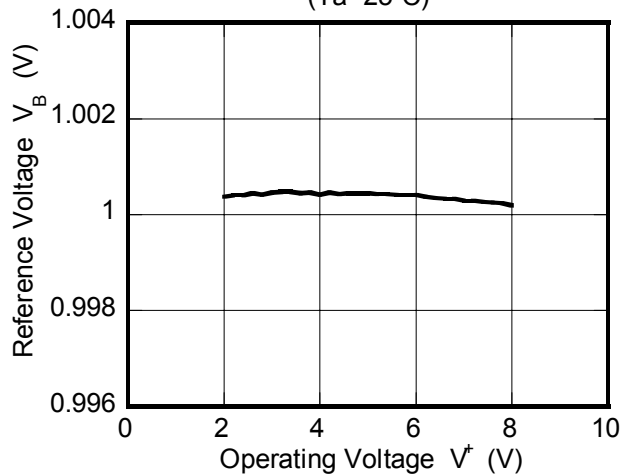

Quiescent Current vs. Operating Voltage

( $R_T = 47k\Omega$ ,  $R_L = \text{Non Load}$ ,  $T_a = 25^\circ C$ )

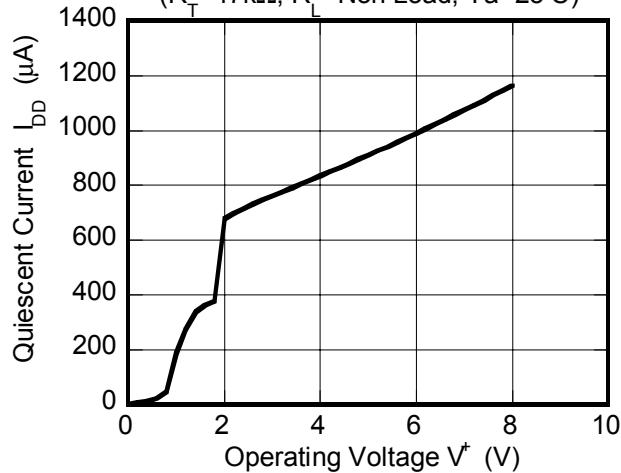

## ■ TYPICAL CHARACTERISTICS

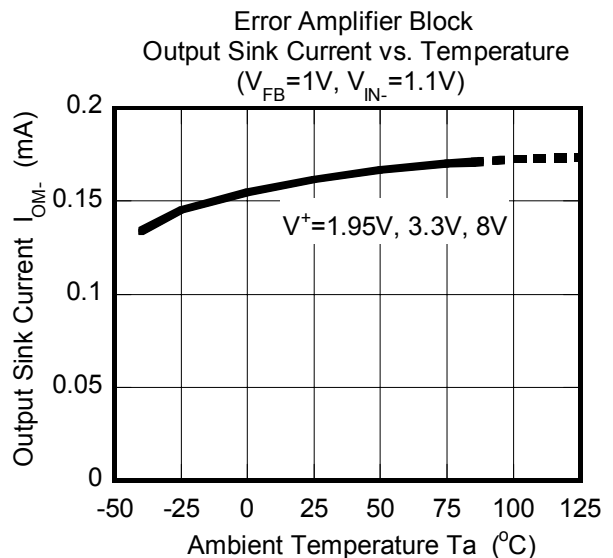
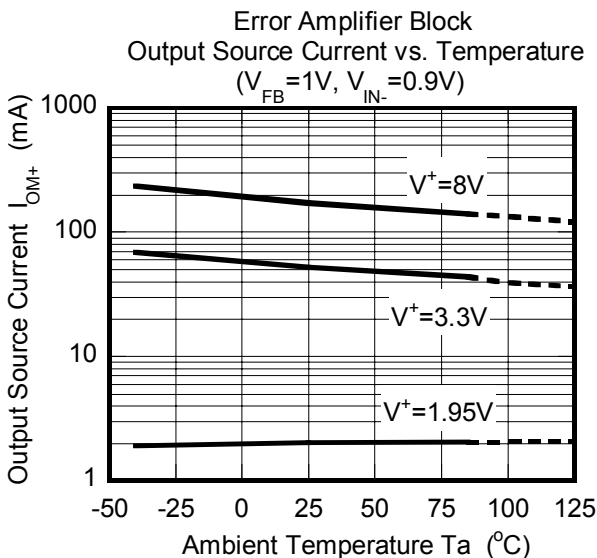
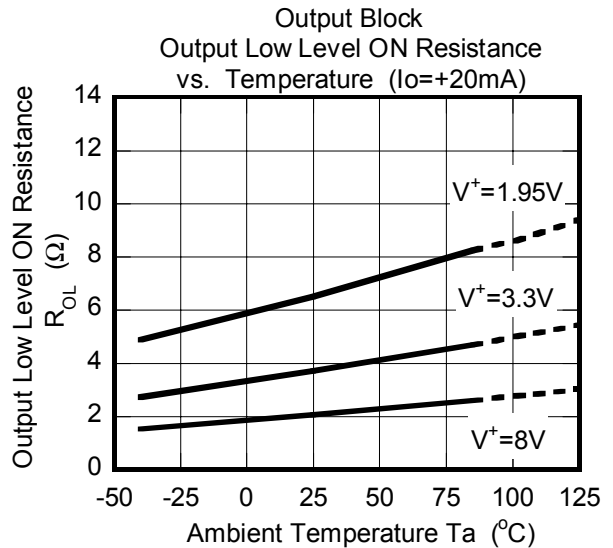
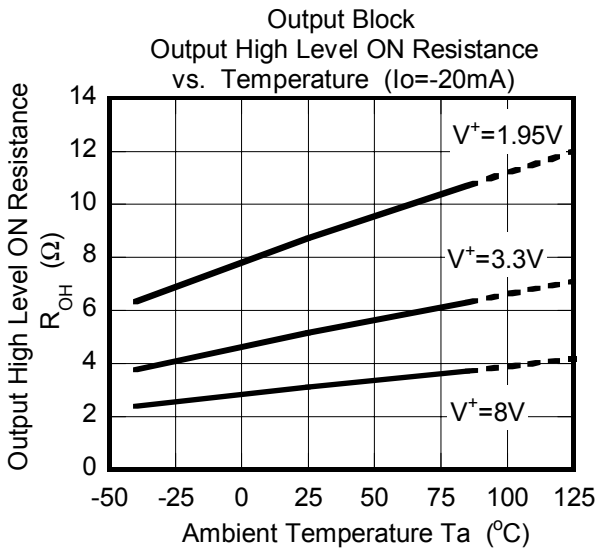
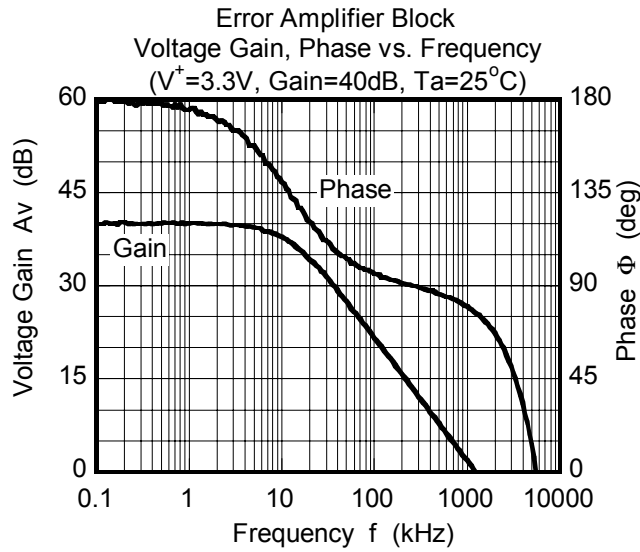

## ■ TYPICAL CHARACTERISTICS

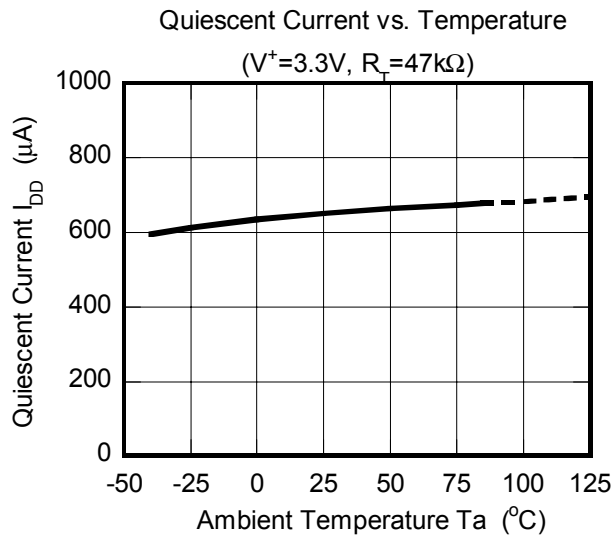
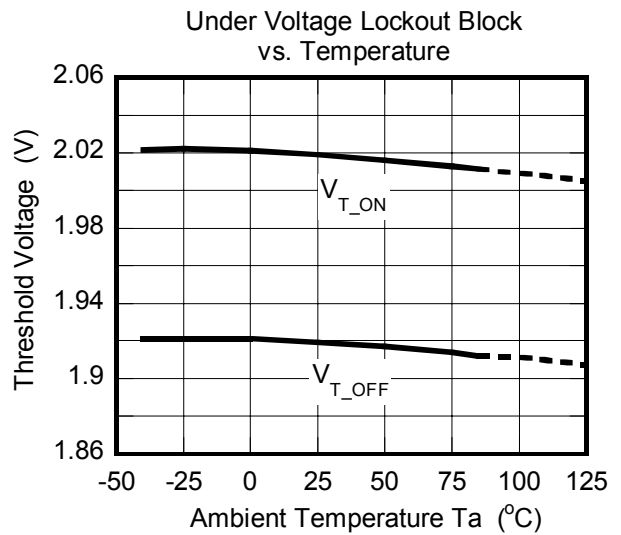
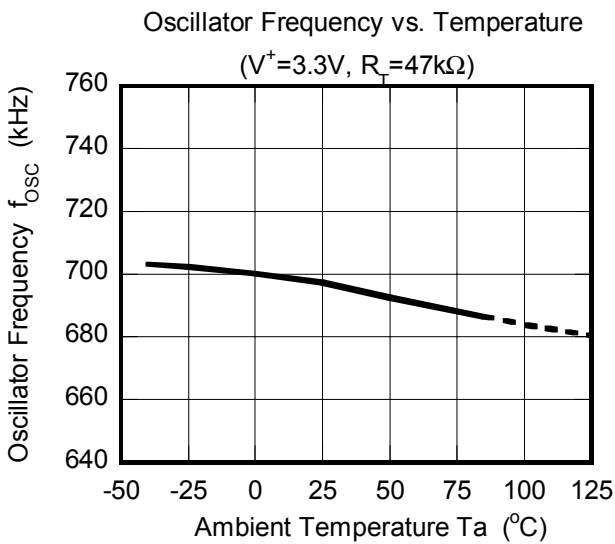
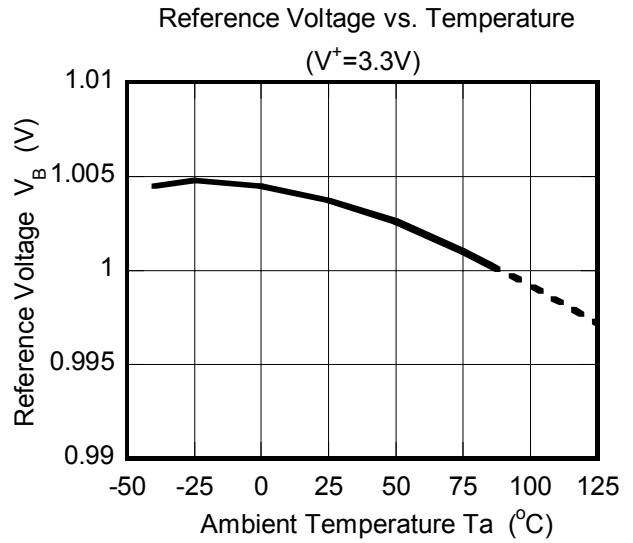
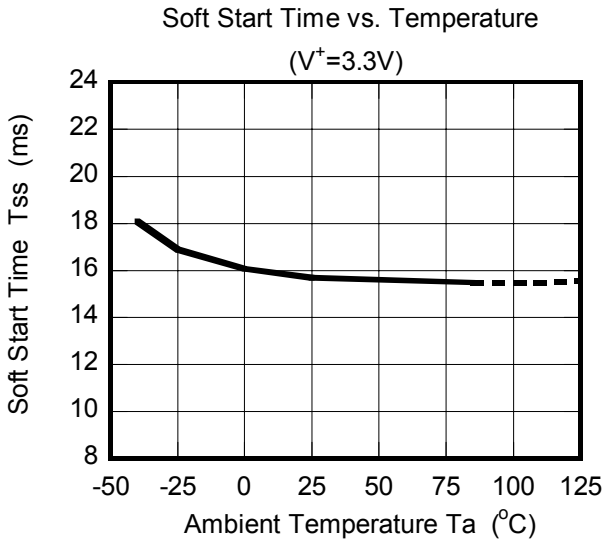



# MEMO

**[CAUTION]**

The specifications on this databook are only given for information, without any guarantee as regards either mistakes or omissions. The application circuits in this databook are described only to show representative usages of the product and not intended for the guarantee or permission of any right including the industrial rights.