

ANALOG FUNCTION SWITCH

■ GENERAL DESCRIPTION

The NJU7312A is a quad 3-channel and dual 2-channel analog function switch, especially suitable for input selector of audio equipments.

The high break down voltage analog switch controlled by 14-bit serial data based on logic operating voltage (5V) can ON and OFF of $\pm 15V$ signal.

The analog switch is realized superior linearity of on-resistance in all voltage range, low distortion and wide dynamic range.

Furthermore, the both of single and dual power supply application provides easy designing.

■ PACKAGE OUTLINE

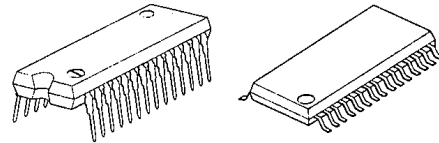

NJU7312AL

NJU7312AM

6

■ FEATURES

- Analog switch: quad 3 channel and dual 2 channel.
- High Break Down Voltage $\pm 15V$.
- Low Distortion THD: 0.002% (typ).
- Superior Linearity of ON Resistance.
- Serial Data Control.
- Package Outline SDIP 28 / DMP 30
- C-MOS Technology

■ PIN CONFIGURATION

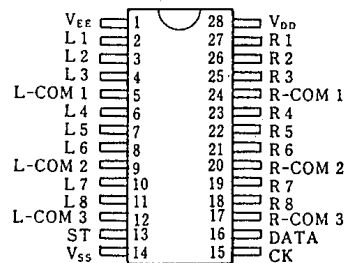

■ BLOCK DIAGRAM

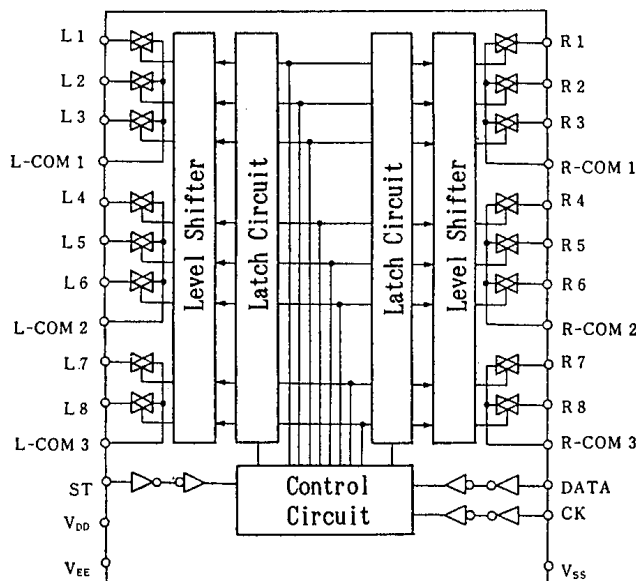

NJU7312AL

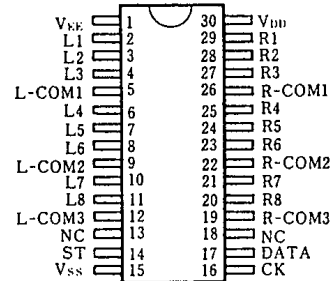

NJU7312AM

TERMINALS DESCRIPTION

No.		SYMBOL	FUNCTIONS	No.		SYMBOL	FUNCTIONS
DIP	DMP			DIP	DMP		
1	1	V _{EE}	Negative Voltage Supply	15	16	CK	Clock input
2	2	L1	Analog switch input/output	16	17	DATA	Data input
3	3	L2		17	19	R-COM3	R7, L8 Common
4	4	L3		18	20	R8	Analog switch input/output
5	5	L-COM1		19	21	R7	
6	6	L4	Analog switch input/output	20	22	R-COM2	R4, R5, R6 Common
7	7	L5		21	23	R6	Analog switch input/output
8	8	L6		22	24	R5	
9	9	L-COM2		23	25	R4	
10	10	L7	Analog switch input/output	24	26	R-COM1	R1, R2, R3 Common
11	11	L8		25	27	R3	Analog switch input/output
12	12	L-COM3	26	28	R2		
13	14	ST	Chip enable	27	29	R1	
14	15	V _{SS}	GND	28	30	V _{DD}	Positive voltage supply

6
FUNCTIONAL DESCRIPTION

(1) Timing of DATA, CK, ST

The Serial Input Data is input to internal shift register sequentially synchronized by clock signal rising edge input from CK terminal (100 kHz max.).

The Serial Input Data in the shift register is transferred to latch circuit and renew by synchronized rising edge of Chip enable signal input from ST terminal.

(Timing Chart)

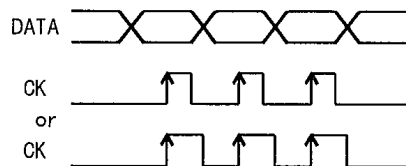

(Detailed Timing)

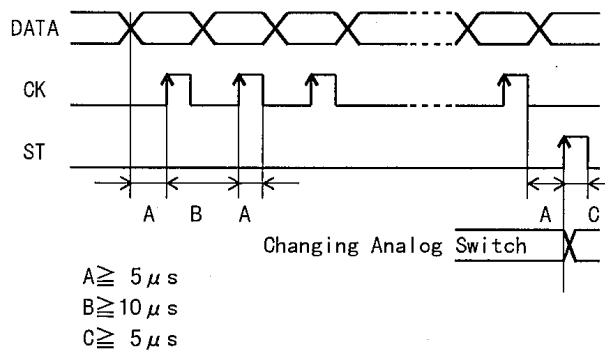

(2) Data Format

The 14-bit serial data strings format from MSB to LSB are 8-bit analog switch control data, 2-bit right and left channel selection data and 4-bit address data.

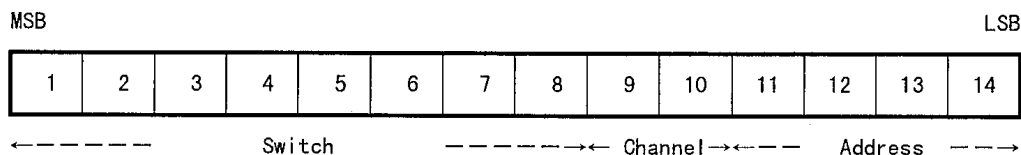

(Switch)

Bit1 ~ bit8 select the analog switch ON and OFF 0: switch off
 1: switch on

(Channel)

Bit9 and 10 select the channel.

bit9	bit10	CHANNEL
1	1	L and R
1	0	R only
0	1	L only

(Address)

Bit11 to 14 select the address. This address select is used for chip selection when this LSI is connected to the common bus line.

Type No.	bit11	bit12	bit13	bit14
NJU7311A	0	0	0	0
NJU7312A	1	0	0	0
NJU7313A	0	1	0	0

6

(3) Supply Voltage

The power supply of NJU7312A is divided into two portions of analog switch part and control part. The analog switch part operate by dual power supply (+ and -) and control part is operated by single power supply (+) only.

The analog switch part can be also operated by single power supply. In this case, the supply voltage should be half of dual supply operation mode.

Furthermore, the CK, DATA and ST terminals realize direct interface with 5V operated family because of its input threshold level is adjusted.

Dual Power Supply (+ and -)

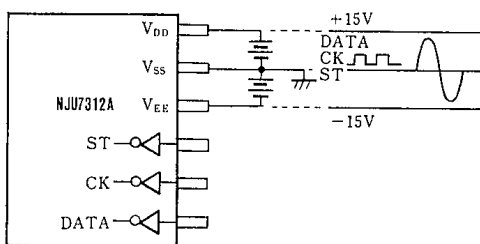

Single Power Supply (+)

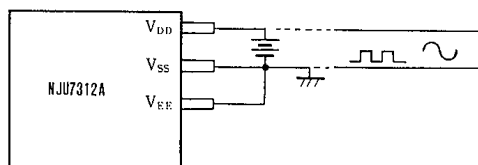

■ ABSOLUTE MAXIMUM RATINGS

(Ta=25°C)

PARAMETER	SYMBOL	RATINGS	UNIT
Supply Voltage	$V_{DD} - V_{EE}$ $V_{DD} - V_{SS}$ $V_{EE} - V_{SS}$	34 +17 -17	V
Input Voltage	V_{IN}	$V_{SS}-0.3 \sim V_{DD}+0.3$	V
Power Dissipation	P_D	300	mW
Operating Temperature	T_{opr}	-30 ~ +75	°C
Storage Temperature	T_{stg}	-40 ~ +125	°C

■ ELECTRICAL CHARACTERISTICS

 (V_{DD}=+16V, V_{SS}=0V, V_{EE}=-16V, Ta=25°C)

6

PARAMETER	SYMBOL	CONDITIONS	MIN	TYP	MAX	UNIT
Operating Voltage	$V_{DD}-V_{SS}$ $V_{EE}-V_{SS}$		8 -16		16 -8	V
Operating Current	I_{DD}	V _{DD} =+16V, V _{EE} =-16V, V _{SS} =0V			3	mA
Back-Up Voltage	V_B		4		16	V
Back-Up Current	I_B	V _{DD} =+4V, V _{SS} =V _{EE} =0V, Circ.1			10	μA
High-Level Input Voltage	V_{IH}	CK, DATA, ST Terminals	4		16	V
Low-Level Input Voltage	V_{IL}	CK, CATA, ST Terminals	0		1	V
Min. Operating Pulse Width	t_{MIN}		5			μS
Switch ON Resistance	R_{ON}	Circ.2		100	200	Ω
Total Harmonic Distortion	THD	$f_{IN}=20 \sim 20kHz, V_{IN}=1V_{rms}$ Circ.3		0.002	0.005	%

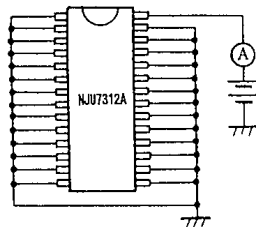
■ MEASUREMENT CIRCUIT DIAGRAMS

(Circ.1)

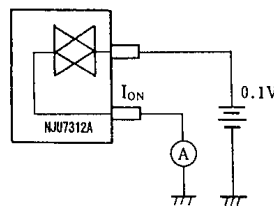

(Circ.2)

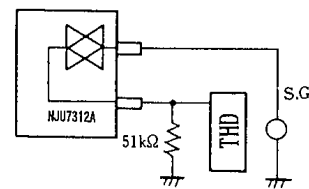

(Circ.3)

MEMO

[CAUTION]

The specifications on this databook are only given for information, without any guarantee as regards either mistakes or omissions. The application circuits in this databook are described only to show representative usages of the product and not intended for the guarantee or permission of any right including the industrial rights.