

RS232C LINE DRIVER/RECEIVER

■ GENERAL DESCRIPTION

The NJU6402B is a RS232C line driver/receiver composed of 3 drivers and 3 receivers.

The drivers convert the input of TTL level signals into RS232C level signals and limit the slew rate below $30V/\mu s$.

The receivers accept the input levels both of RS-232C standard minimum requirement level ($\pm 3V$) and TTL level.

Furthermore, the hysteresis circuit and noise filter incorporated on each receiver ensures noise-free operation.

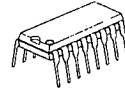
■ PACKAGE OUTLINE

NJU6402BD



NJU6402BM

■ FEATURES

- Based on the RS232C Standard
- 3 Drivers and 3 Receivers
- Low Operating Current
- Driver Output Voltage --- $\pm 25V$
- Receiver Input Voltage --- $\pm 27V$
- Output Impedance at Power-off (Driver) --- 300Ω (Min)
- Slew Rate (Driver) --- $30V/\mu s$ (Max)
- TTL-compatible Input (Driver)
- TTL-compatible Input/Output (Receiver)
- Hysteresis Input (Receiver)
- Noise Filter On-chip (Receiver)
- Package Outline --- DIP/DMP 16
- C-MOS Technology

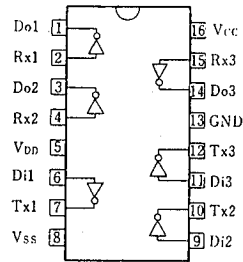
■ PIN CONFIGURATION

7

■ BLOCK DIAGRAM

(1) Driver Section (1-circuit)

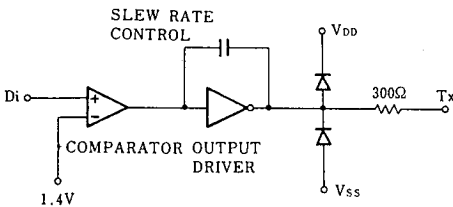

(2) Receiver Section (1-circuit)

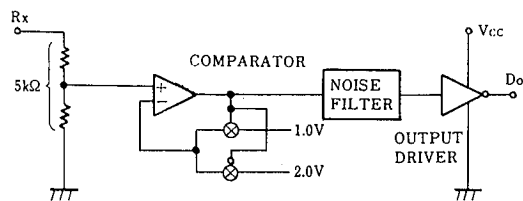

■ TERMINAL DESCRIPTION

NO.	SYMBOL	F U N C T I O N	NO.	SYMBOL	F U N C T I O N
1	Do1	Receiver Output 1	9	Di2	Driver Input 2
2	Rx1	Receiver Input 1	10	Tx2	Driver Output 2
3	Do2	Receiver Output 2	11	Di3	Driver Input 3
4	Rx2	Receiver Input 2	12	Tx3	Driver Output 3
5	V _{DD}	Driver Positive Voltage Supply (+12V)	13	GND	Ground
6	Di1	Driver Input 1	14	Do3	Receiver Output 3
7	Tx1	Driver Output 1	15	Rx3	Receiver Input 3
8	V _{SS}	Driver Negative Voltage Supply (-12V)	16	V _{CC}	Logic Operating Voltage Supply(+5V)

7
■ FUNCTIONAL DESCRIPTION
(1) Driver Section

The drivers output the RS-232C standard signals which are converted from the TTL level signal to RS-232C standard level by the level shifter and limit the slew rate below $30V/\mu s$ ($6V/\mu s$ typ), to the RS-232C lines.

The each driver incorporate series resistance to keep the output impedance to 300Ω or more during the power-off. This series resistance also protect the internal circuits against the overvoltage of $\pm 25V$ impressed from outside.

(2) Receiver Section

The input of each receiver incorporate the resistor (TYP: $5k\Omega$) as the drivers load. This resistor also protect the internal circuits against the overvoltage of $\pm 27V$. The receiver accept the both of $\pm 3V$ of RS-232C standard minimum requirement level and TTL level as the threshold voltage of input comparators are adjusted for both input levels.

The noise less than $1V_{P-P}$ and spike noise below $3\mu s$ pulse width are eliminated by the hysteresis circuits and noise filter.

The output signals are TTL compatible and capable of 8-LSTTL driving.

■ ABSOLUTE MAXIMUM RATINGS

(Ta=25°C)

PARAMETER		SYMBOL	RATINGS	UNIT
Supply Voltage		V _{CC} V _{DD} V _{SS}	-0.3 ~ +6 V _{CC} ~ +14 (Note1) +0.3 ~ -14	V
Receiver	Input Voltage	V _{RI}	±27	V
	Output Voltage	V _{DO}	-0.3 ~ V _{CC} +0.3	
Driver	Input Voltage	V _{DI}	-0.3 ~ V _{CC} +0.3	V
	Output Voltage	V _{TX}	±25	V
	Output Current	I _{TX}	±60	mA
Power Dissipation		P _D	DIP 500	mW
Operating Temperature		T _{opr}	-20 ~ +75	°C
Storage Temperature		T _{stg}	-65 ~ +150	°C

Note1) The V_{DD} level must be maintained higher than V_{CC} level. If the V_{CC} rise up before V_{DD} supply when the power is turned on, the latch-up may occur because of the reverse current flows from V_{CC} to V_{DD}. If there are possibilities of early V_{CC} supply, the diode connect to V_{DD} and V_{SS} terminals shown in application circuits are required.

7
■ ELECTRICAL CHARACTERISTICS

(Ta=25°C)

PARAMETER	SYMBOL	CONDITIONS	MIN	TYP	MAX	UNIT
Quiescent Current	I _{CC}	V _{CC} =5.5V V _{DD} =12V V _{SS} =-12V			1	mA
	I _{DD}				1	
	I _{SS}				1	
Operating Voltage	V _{CC}		4.5		5.5	V
	V _{DD}		4.5		12	
	V _{SS}		-12		-4.5	

■ DRIVER ELECTRICAL CHARACTERISTICS

 (Ta=25°C, 4.5 ≤ V_{CC} ≤ 5.5V, V_{DD}=4.5~12V, V_{SS}=-4.5V~-12V, GND=0V)

PARAMETER	SYMBOL	CONDITIONS		MIN	TYP	MAX	UNIT
Input Voltage H Level L Level	V _{IH}			2.0			V
	V _{IL}					0.8	
Maximum Input Current	I _{IL} , I _{IH}	V _{IN} =GND or V _{DD}		-10		+10	μA
H Level Output Voltage	V _{OH}	V _{IN} =V _{IL}	V _{DD} =+4.5V, V _{SS} =-4.5V	3.0			V
			V _{DD} =+9V, V _{SS} =-9V	6.5			
			V _{DD} =+12V, V _{SS} =-12V	9.0			
L Level Output Voltage	V _{OL}	V _{IN} =V _{IH}	V _{DD} =+4.5V, V _{SS} =-4.5V			-3.0	V
			V _{DD} =+9V, V _{SS} =-9V			-6.5	
			V _{DD} =+12V, V _{SS} =-12V			-9.0	
Output Short Current (Note 2)	I _{OS} ⁺	V _{OUT} =GND, V _{DD} =+12V	V _{IN} =V _{IL}			+45	mA
	I _{OS} ⁻			V _{SS} =-12V	V _{IN} =V _{IH}	-45	
Output Impedance	R _{OUT}	V _{CC} =V _{DD} =V _{SS} =0V, -2V ≤ V _{OUT} ≤ +2V		300			Ω

Note 2) The output short current is specified by 1 output terminal. If plural outputs short at once, the NJU6402B may destroy due to the power over the package power dissipation.

■ DRIVER AC CHARACTERISTICS

 (Ta=25°C, 4.5 ≤ V_{CC} ≤ 5.5V, V_{DD}=4.5~12V, V_{SS}=-4.5V~-12V, GND=0V, R_L=3kΩ, C_L=50pF) (Note 3,4)

PARAMETER	SYMBOL	CONDITIONS	MIN	TYP	MAX	UNIT
Propagation Delay Time	t _{odI}	V _{DD} =+4.5V, V _{SS} =-4.5V V _{DD} =+9V, V _{SS} =-9V V _{DD} =+12V, V _{SS} =-12V			6.0 5.0 4.0	μs
Propagation Delay Time	t _{odO}	V _{DD} =+4.5V, V _{SS} =-4.5V V _{DD} =+9V, V _{SS} =-9V V _{DD} =+12V, V _{SS} =-12V			6.0 5.0 4.0	μs
Rise/Fall Time (Note 5)	t _r /t _f		0.2			μs
Delay Time Skew	t _{sk}	V _{DD} =+12V, V _{SS} =-12V		400		ns
Slew Rate (Note 5)	S _R	R _L =3 to 7kΩ, 15pF ≤ C _L ≤ 2.5nF		6	30	V/μs

 Note 3) AC input waveform: t_r=t_f ≤ 20ns, V_{IH}=2.0V, V_{IL}=0.8V

Note 4) Input Rise/Fall time are less than 5μs.

Note 5) Output slew rate, output rise time and fall time are specified output waveform changing time either from +3V to -3V or -3V to +3V.

7
■ RECEIVER ELECTRICAL CHARACTERISTICS

 (Ta=25°C, 4.5 ≤ V_{CC} ≤ 5.5V, V_{DD}=4.5~12V, V_{SS}=-4.5V~-12V, GND=0V)

PARAMETER	SYMBOL	CONDITIONS	MIN	TYP	MAX	UNIT
Input Voltage H Level L Level	V _P V _N		1.3 0.5	2.0 1.0	2.5 1.7	V
Hysteresis Voltage	V _H			1.0		V
Input Impedance	R _{IN}	V _{IN} =±3V~±12V	3	5	7	kΩ
Output Voltage H Level L Level	V _{OH} V _{OL}	V _{IN} =V _N (Min.), I _{OUT} =-3.2mA V _{IN} =V _P (Max.), I _{OUT} =+3.2mA	2.8		0.4	V

■ RECEIVER AC CHARACTERISTICS

 (Ta=25°C, 4.5 ≤ V_{CC} ≤ 5.5V, V_{DD}=4.5~12V, V_{SS}=-4.5V~-12V, GND=0V, C_L=50pF) (Note 6)

PARAMETER	SYMBOL	CONDITIONS	MIN	TYP	MAX	UNIT
Propagation Delay Time	t _{PLH} , t _{PHL}	Input Pulse Width ≥ 10μs			6.5	μs
Delay Time Skew	t _{sk}			400		ns
Output Rise Time	t _r				300	ns
Output Fall Time	t _f				300	ns

 Note 6) AC input waveform t_r=t_f=200ns, V_{IH}=+3V, V_{IL}=-3V, f=20kHz.

■ MEASUREMENT CIRCUITS

(1) Driver AC Characteristics

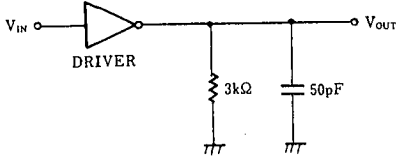

(2) Receiver AC Characteristics

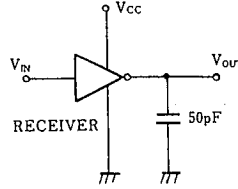

■ MEASUREMENT WAVEFORM

(1) Driver AC Characteristics

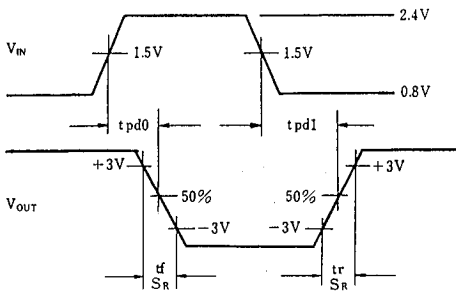

(2) Receiver AC Characteristics

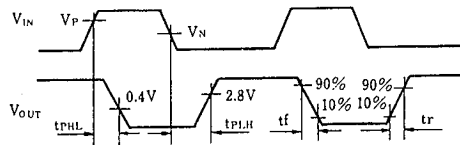

■ APPLICATION CIRCUIT

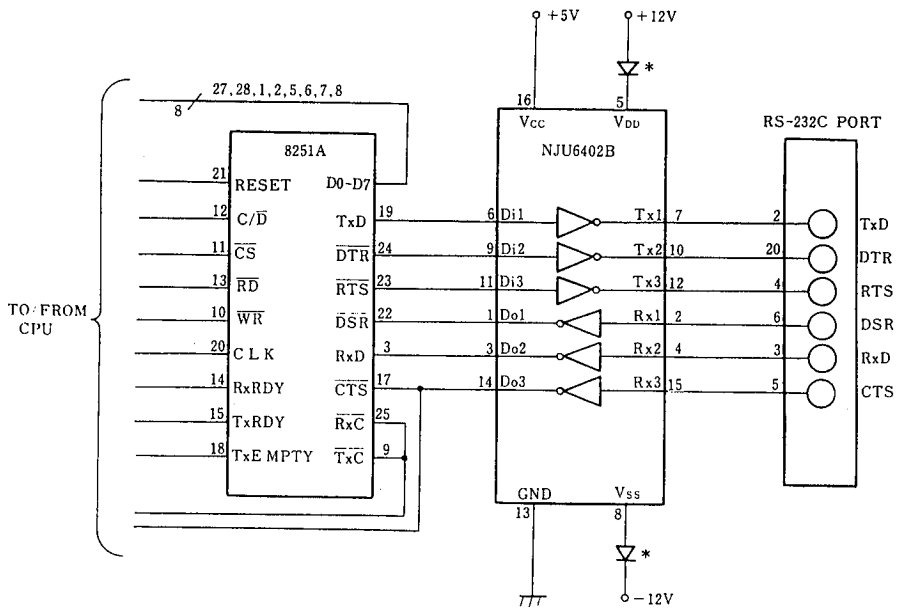

RS-232C port

* External diode for protective use.
 Protection of in case +5V voltage supplied before than +12V and overvoltage stress.

NJU6402B

www.DataSheet4U.com

MEMO

[CAUTION]

The specifications on this databook are only given for information, without any guarantee as regards either mistakes or omissions. The application circuits in this databook are described only to show representative usages of the product and not intended for the guarantee or permission of any right including the industrial rights.