

LOW DROPOUT VOLTAGE REGULATOR

■ GENERAL DESCRIPTION

The NJM2867/68 is a 100mA output low dropout voltage regulator with ON/OFF control.

Advanced Bipolar technology achieves low noise, high ripple rejection and low quiescent current.

Small packaging, 0.1 μ F small decoupling capacitor, built-in noise bypass capacitor make the NJM2865/66 suitable for space conscious applications.

■ PACKAGE OUTLINE



NJM2867F3

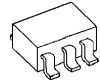

NJM2867F/NJM2868F

■ FEATURES

- High Ripple Rejection 75dB typ. (f=1kHz Vo=3V Version)
- Output Noise Voltage Vno=40 μ Vrms typ.
- Output capacitor with 0.1 μ F ceramic capacitor (Vo \geq 2.8V)
- Output Current Io(max.)=100mA
- High Precision Output Vo \pm 1.0%
- Low Dropout Voltage 0.10V typ. (Io=60mA)
- ON/OFF Control (Active High)
- Internal Short Circuit Current Limit
- Internal Thermal Overload Protection
- Bipolar Technology
- Package Outline SC88A (NJM2867F3), SOT-23-5 (NJM2867F/NJM2868F)

■ PIN CONFIGURATION

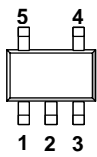

NJM2867F/NJM2867F3

- PIN FUNCTION**
- 1.CONTROL
 - 2.GND
 - 3.NC
 - 4.V_{OUT}
 - 5.V_{IN}

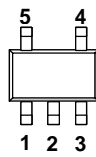

NJM2868F

- PIN FUNCTION**
1. V_{IN}
 - 2.GND
 - 3.CONTROL
 - 4.NC
 - 5.V_{OUT}

■ EQUIVALENT CIRCUIT

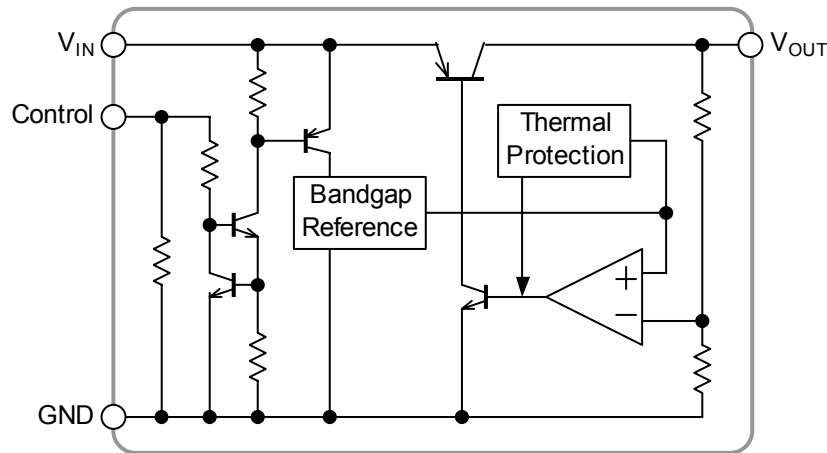

■ OUTPUT VOLTAGE RANK LIST

●NJM2867

Device Name	V _{OUT}	Device Name	V _{OUT}	Device Name	V _{OUT}
NJM2867F3-/F21	2.1V	NJM2867F3-/F29	2.9V	NJM2867F3-/F34	3.4V
NJM2867F3-/F24	2.4V	NJM2867F3-/F03	3.0V	NJM2867F3-/F38	3.8V
NJM2867F3-/F25	2.5V	NJM2867F3-/F31	3.1V	NJM2867F3-/F05	5.0V
NJM2867F3-/F26	2.6V	NJM2867F3-/F32	3.2V		
NJM2867F3-/F28	2.8V	NJM2867F3-/F33	3.3V		

●NJM2868

Device Name	V _{OUT}	Device Name	V _{OUT}	Device Name	V _{OUT}
NJM2868F21	2.1V	NJM2868F29	2.9V	NJM2868F34	3.4V
NJM2868F24	2.4V	NJM2868F03	3.0V	NJM2868F38	3.8V
NJM2868F25	2.5V	NJM2868F31	3.1V	NJM2868F05	5.0V
NJM2868F26	2.6V	NJM2868F32	3.2V		
NJM2868F28	2.8V	NJM2868F33	3.3V		

■ ABSOLUTE MAXIMUM RATINGS (Ta=25°C)

PARAMETER	SYMBOL	RATINGS		UNIT
Input Voltage	V _{IN}	+14		V
Control Voltage	V _{CONT}	+14(*1)		V
Power Dissipation	P _D	SC88A	250(*2)	mW
		SOT-23-5	200(*3)	
			350(*2)	
Operating Temperature	Topr	-40~+85		°C
Storage Temperature	Tstg	-40~+125		°C

(*1): When input voltage is less than +14V, the absolute maximum control voltage is equal to the input voltage.

(*2): Mounted on glass epoxy board based on EIA/JEDEC. (114.3x76.2x1.6mm: 2Layers)

(*3): Device itself.

■ ELECTRICAL CHARACTERISTICS

($V_{IN}=V_O+1V$, $C_{IN}=0.1\mu F$, $C_O=0.1\mu F$ ($2.3V < V_O \leq 2.8V$: $C_O=0.22\mu F$, $V_O \leq 2.3V$: $C_O=0.47\mu F$), $T_a=25^\circ C$)

PARAMETER	SYMBOL	TEST CONDITION	MIN.	TYP.	MAX.	UNIT
Output Voltage	V_O	$I_O=30mA$	-1.0%	—	+1.0%	V
Quiescent Current	I_Q	$I_O=0mA$, expect I_{CONT}	—	120	180	μA
Quiescent Current at Control OFF	$I_{Q(OFF)}$	$V_{CONT}=0V$	—	—	100	nA
Output Current	I_O	$V_O=0.3V$	100	130	—	mA
Line Regulation	$\Delta V_O/\Delta V_{IN}$	$V_{IN}=V_O+1V \sim V_O+6V$, $I_O=30mA$	—	—	0.10	%/V
Load Regulation	$\Delta V_O/\Delta I_O$	$I_O=0 \sim 60mA$	—	—	0.03	%/mA
Dropout Voltage	ΔV_{L-O}	$I_O=60mA$	—	0.10	0.18	V
Ripple Rejection	RR	$e_{in}=200mV_{rms}$, $f=1kHz$, $I_O=10mA$, $V_O=3V$ Version	—	75	—	dB
Average Temperature Coefficient of Output Voltage	$\Delta V_O/\Delta T_a$	$T_a=0 \sim 85^\circ C$, $I_O=10mA$	—	± 50	—	ppm/ $^\circ C$
Output Noise Voltage	V_{NO}	$f=10Hz \sim 80kHz$, $I_O=10mA$, $V_O=3V$ Version	—	40	—	μV_{rms}
Control Voltage for ON-state	$V_{CONT(ON)}$		1.6	—	—	V
Control Voltage for OFF-state	$V_{CONT(OFF)}$		—	—	0.6	V

The above specification is a common specification for all output voltages.

Therefore, it may be different from the individual specification for a specific output voltage.

■ TEST CIRCUIT

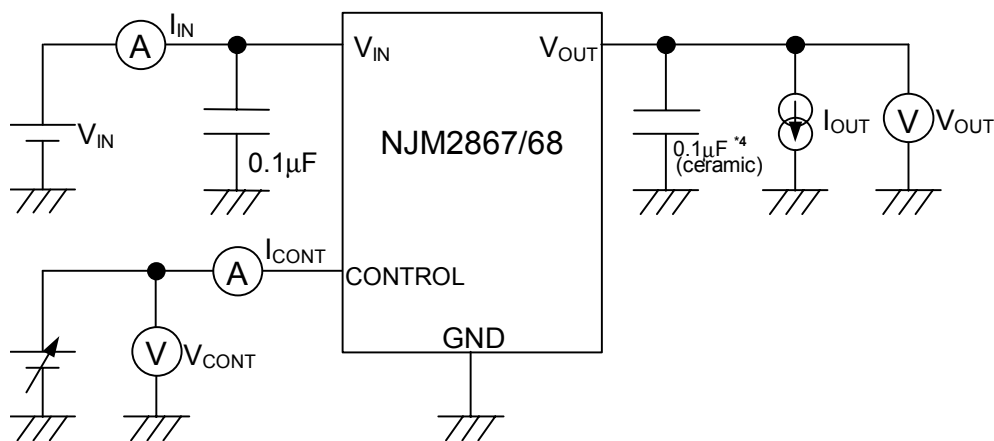

*4 2.3V < $V_O \leq 2.8V$ version: $C_O=0.22\mu F$ (ceramic)
 $V_O \leq 2.3V$ version: $0.47\mu F$ (ceramic)

■ TYPICAL APPLICATION

① In the case where ON/OFF Control is not required:

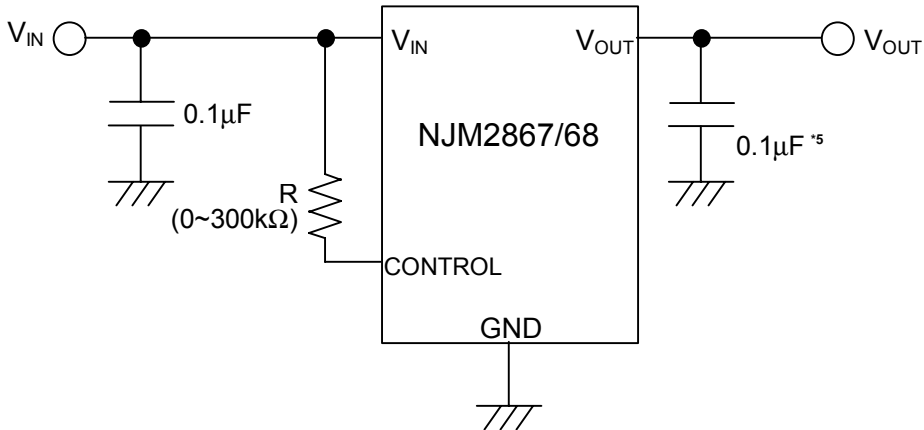

*5 2.3V<V_o≤2.8V version: C_o=0.22µF
 V_o≤2.3V version: 0.47µF

Connect control terminal to V_{IN} terminal

The quiescent current can be reduced by using a resistance “R”. Instead, it increases the minimum operating voltage. For further information, please refer to Figure “Output Voltage vs. Control Voltage”.

② In use of ON/OFF CONTROL:

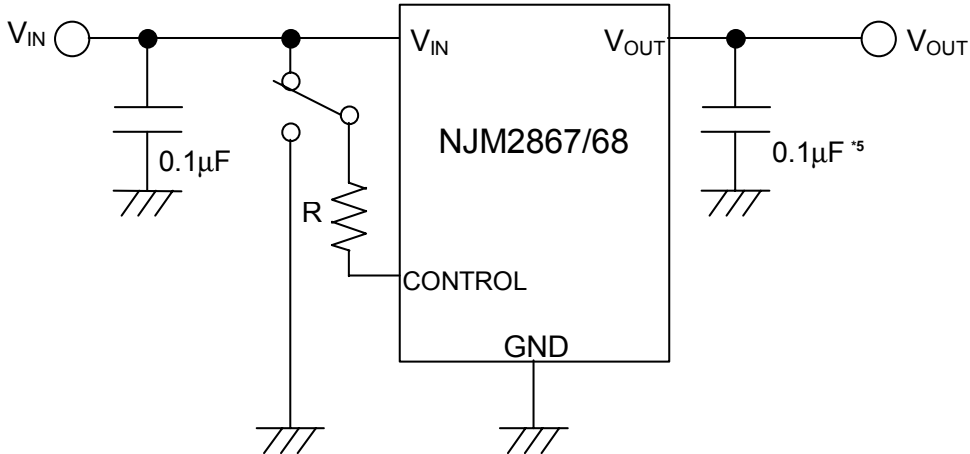

*5 2.3V<V_o≤2.8V version: C_o=0.22µF
 V_o≤2.3V version: 0.47µF

State of control terminal:

- “H” → output is enabled.
- “L” or “open” → output is disabled.

■ POWER DISSIPATION vs. AMBIENT TEMPERATURE

NJM2867/68F Power Dissipation
($T_{opr} = -40 \sim +85^{\circ}\text{C}$, $T_j = 125^{\circ}\text{C}$, $P_D = 200\text{mW}$ ($T_a \leq 25^{\circ}\text{C}$))

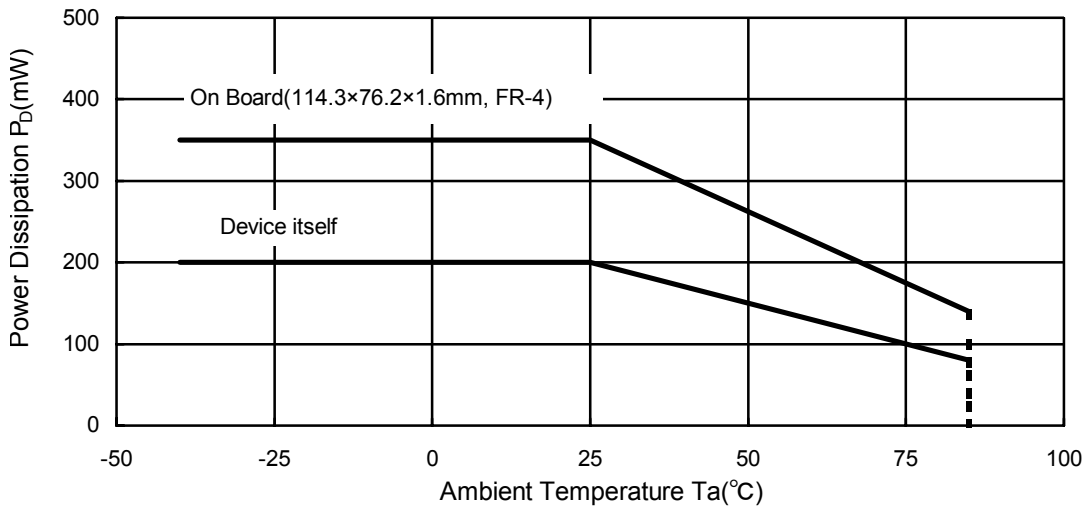

NJM2867F3 Power Dissipation
($T_{opr} = -40 \sim +85^{\circ}\text{C}$, $T_j = 125^{\circ}\text{C}$)

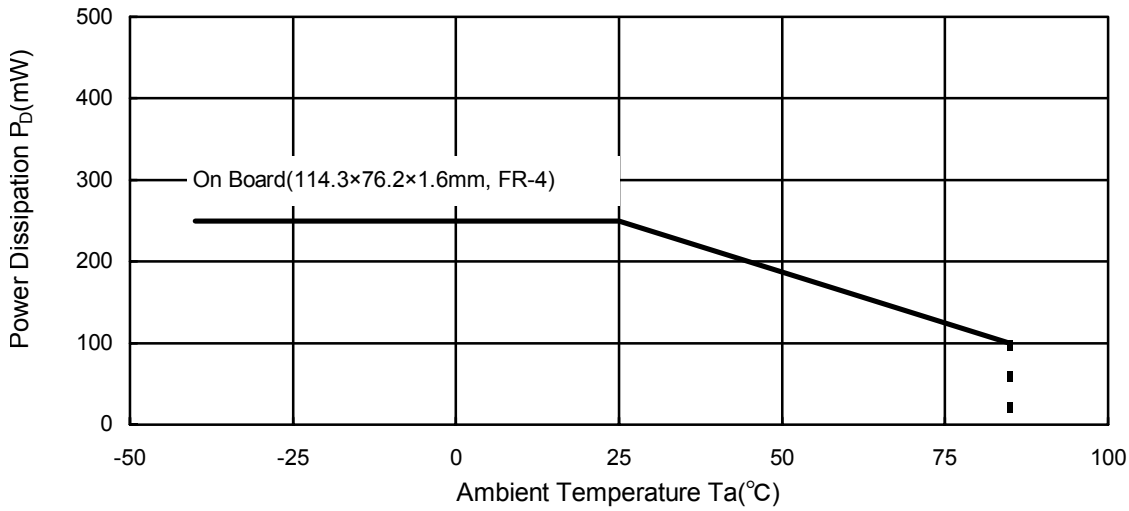

■ ELECTRICAL CHARACTERISTICS

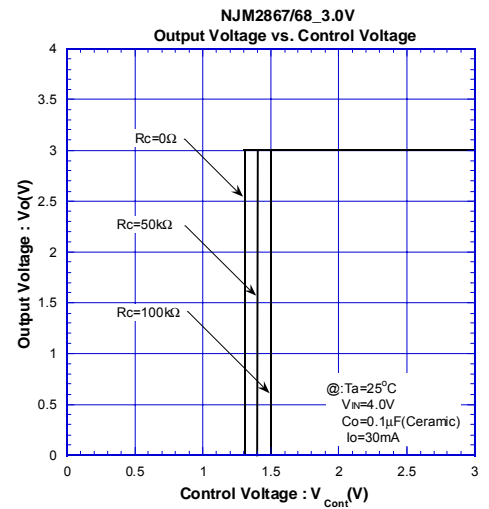
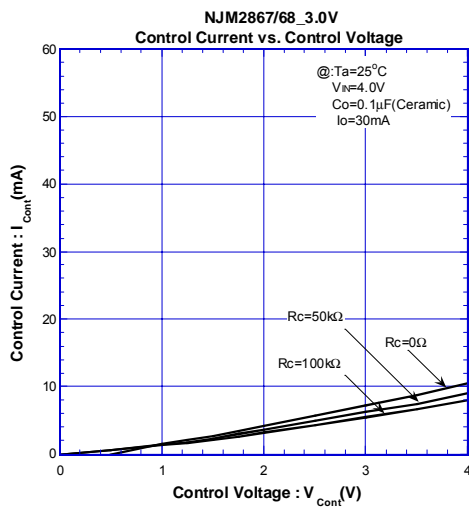
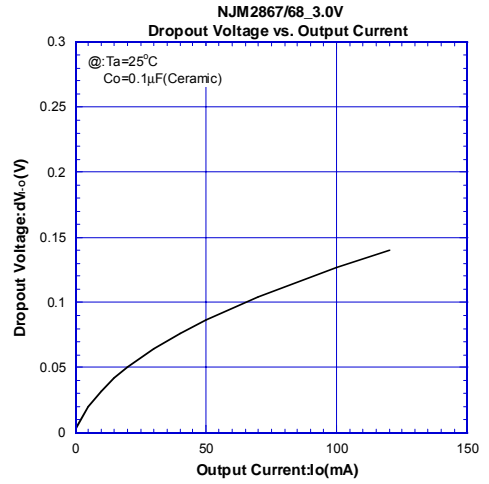
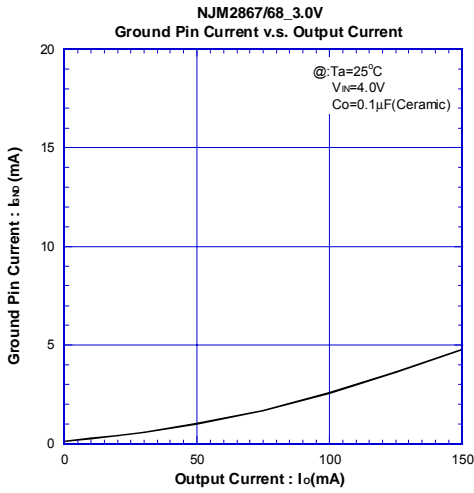
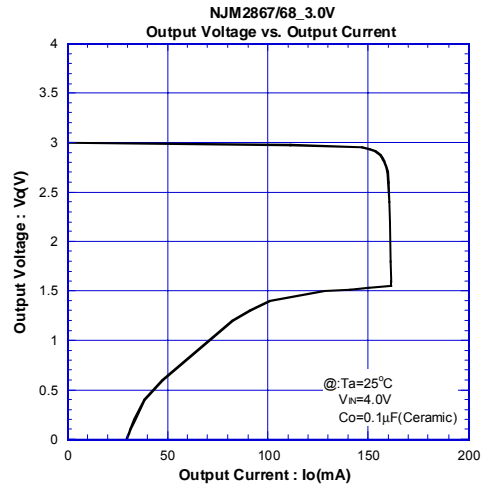
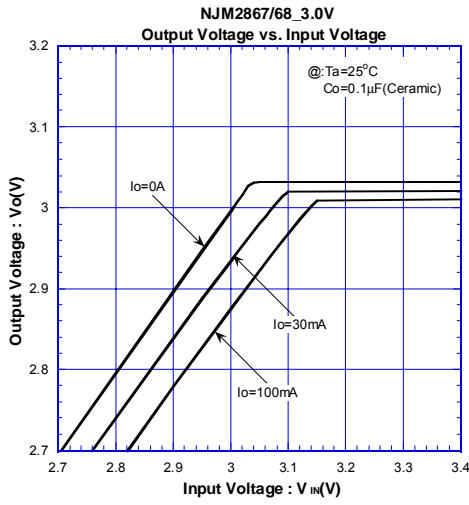

■ ELECTRICAL CHARACTERISTICS

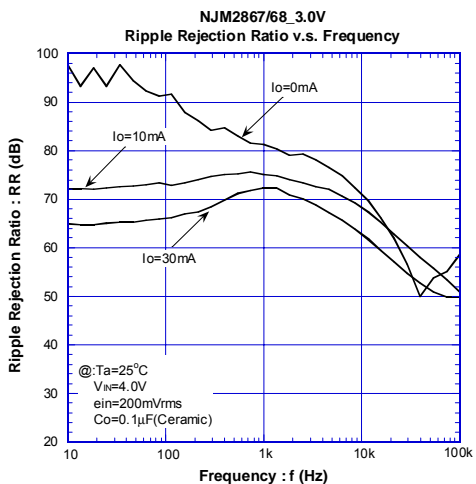
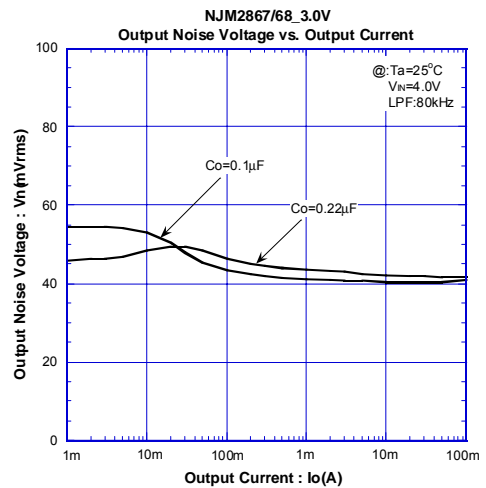
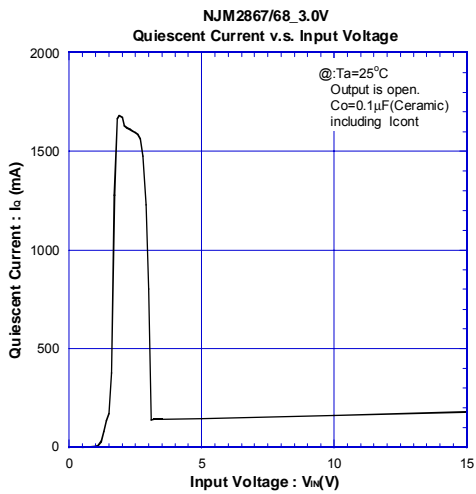
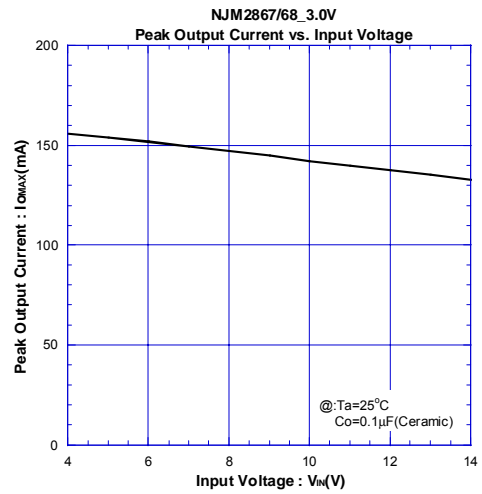
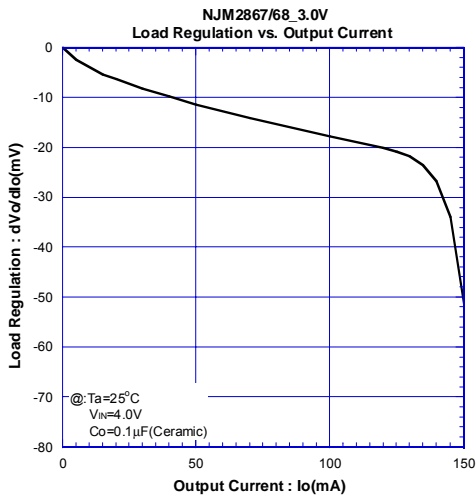

■ ELECTRICAL CHARACTERISTICS

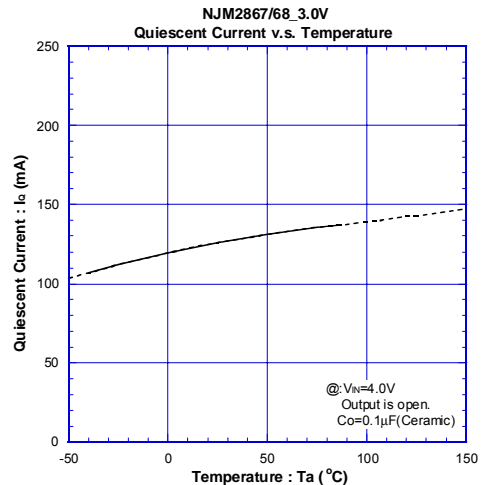
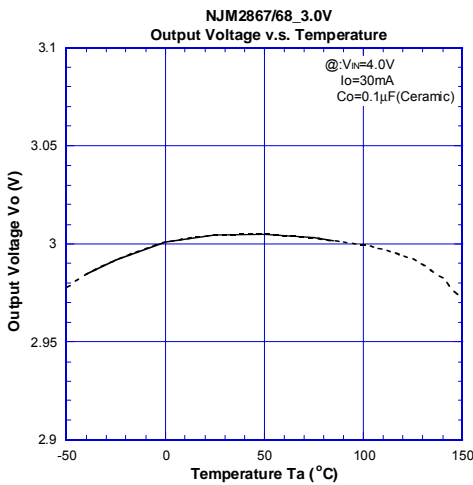
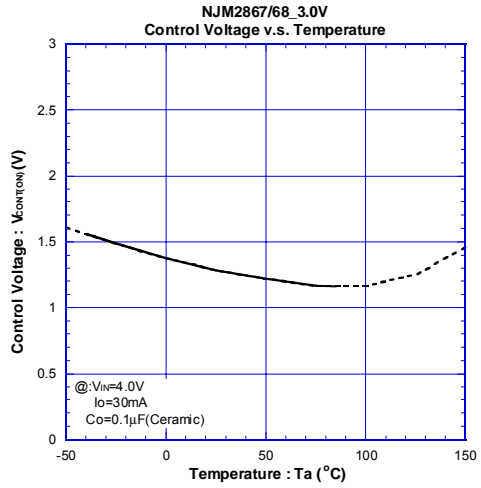
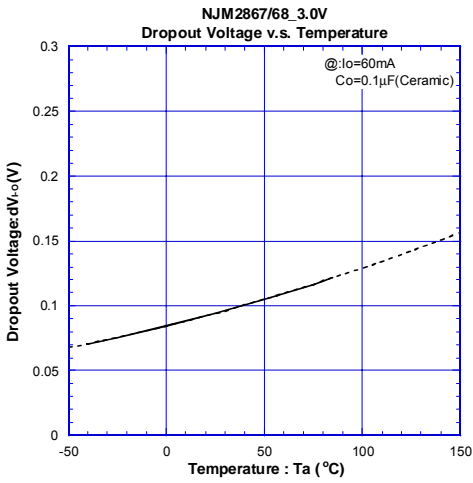
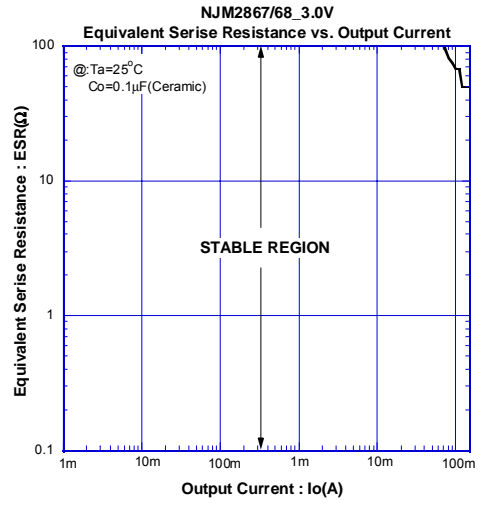
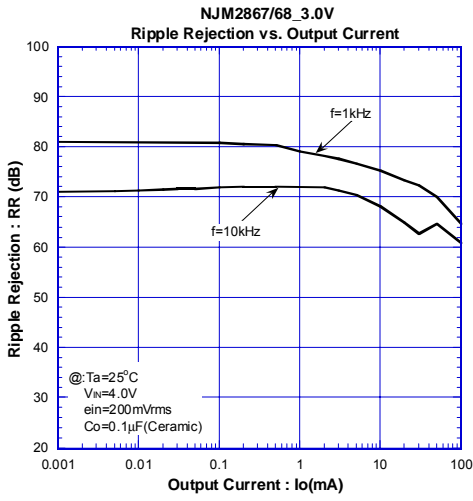

■ ELECTRICAL CHARACTERISTICS

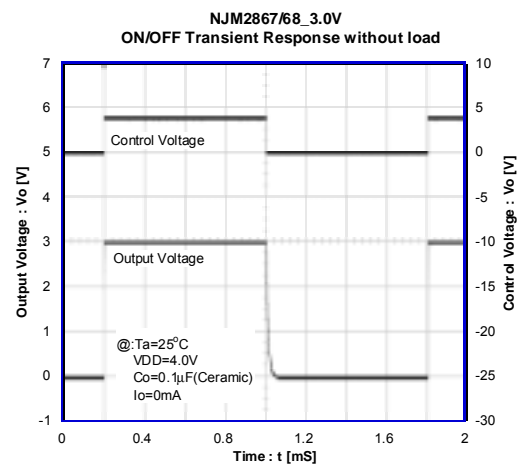
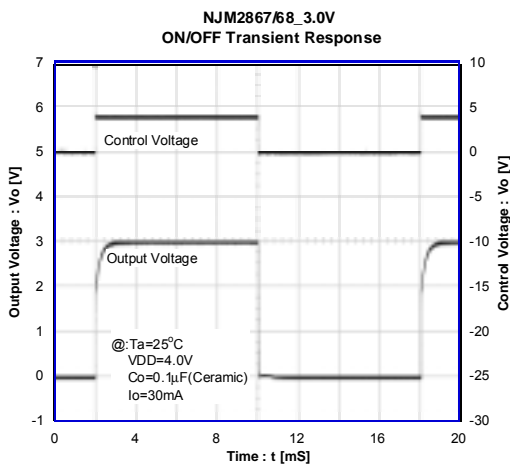
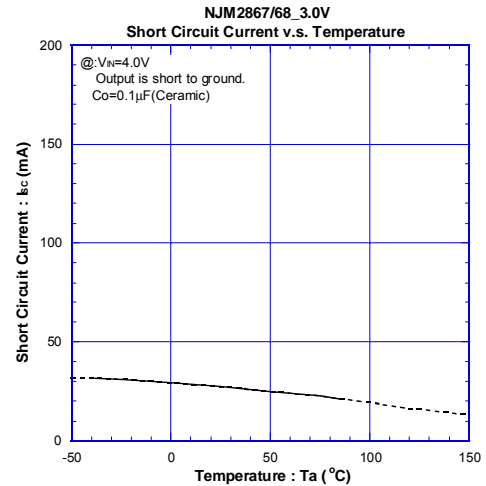
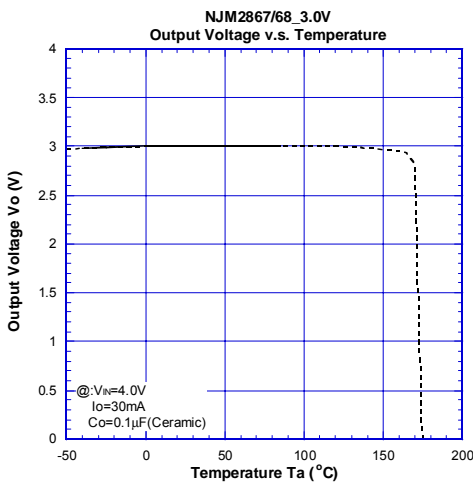
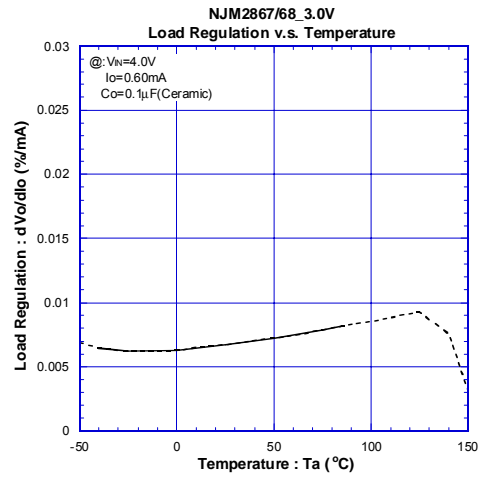
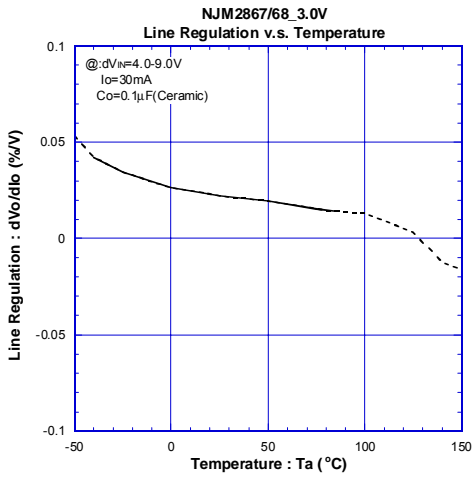

■ ELECTRICAL CHARACTERISTICS

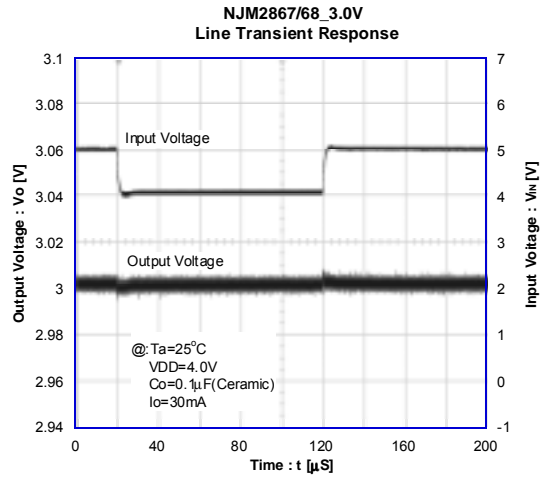
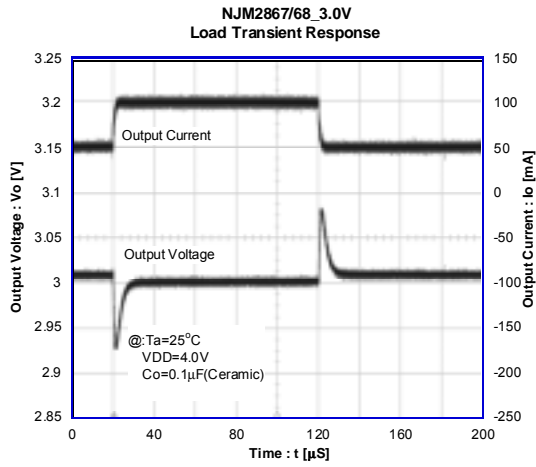

[CAUTION]

The specifications on this databook are only given for information, without any guarantee as regards either mistakes or omissions. The application circuits in this databook are described only to show representative usages of the product and not intended for the guarantee or permission of any right including the industrial rights.